

# ATLAS

# High-Level Trigger, Data Acquisition and Controls

# Technical Design Report

Issue: Final Draft  
Revision: 6  
Reference: ATLAS TDR-016  
Created: 12 November 2002  
Last modified: 23 June 2003  
Prepared By: ATLAS HLT/DAQ/DCS Group

All trademarks, copyright names and products referred to in this document are acknowledged as such.

## ATLAS Collaboration

### Armenia

Yerevan Physics Institute, Yerevan

### Australia

Research Centre for High Energy Physics, Melbourne University, Melbourne  
University of Sydney, Sydney

### Austria

Institut für Experimentalphysik der Leopold-Franzens-Universität Innsbruck, Innsbruck

### Azerbaijan Republic

Institute of Physics, Azerbaijan Academy of Science, Baku

### Republic of Belarus

Institute of Physics, National Academy of Science, Minsk  
National Centre for Particle and High Energy Physics, Minsk

### Brazil

Universidade Federal do Rio de Janeiro, COPPE/EE/IF, Rio de Janeiro

### Canada

University of Alberta, Edmonton  
University of Carleton/C.R.P.P., Carleton  
Group of Particle Physics, University of Montreal, Montreal  
Department of Physics, University of Toronto, Toronto  
Simon Fraser University, Burnaby, BC  
TRIUMF, Vancouver  
Department of Physics, University of British Columbia, Vancouver  
University of Victoria, Victoria

### CERN

European Laboratory for Particle Physics (CERN), Geneva

### China

Joint Cluster formed by IHEP Beijing, USTC Hefei, University of Nanjing and University of Shandong

### Czech Republic

Academy of Sciences of the Czech Republic, Institute of Physics and Institute for Computer Science,  
Prague  
Charles University in Prague, Faculty of Mathematics and Physics, Prague  
Czech Technical University in Prague, Faculty of Nuclear Sciences and Physical Engineering, Faculty of  
Mechanical Engineering, Prague

### Denmark

Niels Bohr Institute, University of Copenhagen, Copenhagen

### France

Laboratoire d'Annecy-le-Vieux de Physique des Particules (LAPP), IN2P3-CNRS, Annecy-le-Vieux  
Laboratoire de Physique Corpusculaire, Université Blaise Pascal, IN2P3-CNRS, Clermont-Ferrand  
Laboratoire de Physique Subatomique et de Cosmologie de Grenoble, IN2P3-CNRS Université Joseph  
Fourier, Grenoble  
Centre de Physique des Particules de Marseille, IN2P3-CNRS, Marseille  
Laboratoire de l'Accélérateur Linéaire, IN2P3-CNRS, Orsay  
LPNHE, Universités de Paris VI et VII, IN2P3-CNRS, Paris  
Commissariat à l'Energie Atomique (CEA), DSM/DAPNIA, Centre d'Etudes de Saclay, Gif-sur-Yvette

### Georgia

Institute of Physics of the Georgian Academy of Sciences and Tbilisi State University, Tbilisi

### Germany

Physikalisches Institut, Universität Bonn, Bonn  
Institut für Physik, Universität Dortmund, Dortmund  
Fakultät für Physik, Albert-Ludwigs-Universität, Freiburg  
Institut für Hochenergiephysik der Universität Heidelberg, Heidelberg  
Institut für Physik, Universität Mainz, Mainz  
Lehrstuhl für Informatik V, Universität Mannheim, Mannheim  
Sektion Physik, Ludwig-Maximilian-Universität München, Munich  
Max-Planck-Institut für Physik, Munich  
Fachbereich Physik, Universität Siegen, Siegen  
Fachbereich Physik, Bergische Universität, Wuppertal

### Greece

Athens National Technical University, Athens  
Athens University, Athens  
Aristotle University of Thessaloniki, High Energy Physics Department and Department of Mechanical  
Engineering, Thessaloniki

### Israel

Department of Physics, Technion, Haifa  
Raymond and Beverly Sackler Faculty of Exact Sciences, School of Physics and Astronomy, Tel-Aviv  
University, Tel-Aviv  
Department of Particle Physics, The Weizmann Institute of Science, Rehovot

### Italy

Dipartimento di Fisica dell'Università della Calabria e INFN, Cosenza  
Laboratori Nazionali di Frascati dell'INFN, Frascati  
Dipartimento di Fisica dell'Università di Genova e INFN, Genova  
Dipartimento di Fisica dell'Università di Lecce e INFN, Lecce  
Dipartimento di Fisica dell'Università di Milano e INFN, Milan  
Dipartimento di Scienze Fisiche, Università di Napoli, Federico II e INFN, Naples  
Dipartimento di Fisica Nucleare e Teorica dell'Università di Pavia e INFN, Pavia  
Dipartimento di Fisica dell'Università di Pisa e INFN, Pisa  
Dipartimento di Fisica dell'Università di Roma I 'La Sapienza' e INFN, Roma  
Dipartimento di Fisica dell'Università di Roma II 'Tor Vergata' e INFN, Roma  
Dipartimento di Fisica dell'Università di Roma III, Roma Tre e INFN, Roma  
Dipartimento di Fisica dell'Università di Udine, Gruppo collegato di Udine INFN, Trieste, Udine

**Japan**

Hiroshima Institute of Technology, Hiroshima  
Department of Physics, Hiroshima University, Higashi-Hiroshima  
KEK, High Energy Accelerator Research Organisation, Tsukuba  
Department of Physics, Faculty of Science, Kobe University, Kobe  
Department of Physics, Kyoto University, Kyoto  
Kyoto University of Education, Kyoto  
Nagasaki Institute of Applied Science, Nagasaki  
Naruto University of Education, Naruto  
Department of Physics, Faculty of Science, Okayama University, Okayama  
Department of Computer Science, Ritsumeikan University, Kusatsu  
Department of Physics, Faculty of Science, Shinshu University, Matsumoto  
International Center for Elementary Particle Physics, University of Tokyo, Tokyo  
Physics Department, Tokyo Metropolitan University, Tokyo  
Department of Applied Physics System, Tokyo University of Agriculture and Technology, Tokyo  
Institute of Physics, University of Tsukuba, Tsukuba

**Morocco**

Faculté des Sciences Ain Chock, Université Hassan II, Casablanca, and Université Mohammed V, Rabat

**Netherlands**

FOM - Institute SAF NIKHEF and University of Amsterdam/NIKHEF  
University of Nijmegen/NIKHEF, Nijmegen

**Norway**

University of Bergen, Bergen  
University of Oslo, Oslo

**Poland**

Henryk Niewodniczanski Institute of Nuclear Physics, Cracow  
Faculty of Physics and Nuclear Techniques of the University of Mining and Metallurgy, Cracow

**Portugal**

Laboratório de Instrumentação e Física Experimental de Partículas (LIP), Lisbon, in collaboration with:  
University of Lisboa, University of Coimbra, University Católica-Figueira da Foz, and University  
Nova de Lisboa

**Romania**

National Institute for Physics and Nuclear Engineering, Institute of Atomic Physics, Bucharest

**Russia**

Institute for Theoretical and Experimental Physics (ITEP), Moscow  
P.N. Lebedev Institute of Physics, Moscow  
Moscow Engineering and Physics Institute (MEPhI), Moscow  
Moscow State University, Moscow  
Butker Institute of Nuclear Physics (BINP), Novosibirsk  
State Research Center of the Russian Federation - Institute for High Energy Physics (IHEP), Protvino  
Petersburg Nuclear Physics Institute (PNPI), Gatchina, St. Petersburg

**JINR**

Joint Institute for Nuclear Research, Dubna

**Republic of Serbia**

Institute of Physics, University of Belgrade, Belgrade

**Slovak Republic**

Bratislava University, Bratislava, and Institute of Experimental Physics of the Slovak Academy of  
Sciences, Kosice

**Slovenia**

Jožef Stefan Institute and Department of Physics, University of Ljubljana, Ljubljana

**Spain**

Institut de Física d'Altes Energies (IFAE), Universidad Autónoma de Barcelona, Bellaterra, Barcelona  
Physics Department, Universidad Autónoma de Madrid, Madrid  
Instituto de Física Corpuscular (IFIC), Centro Mixto Universidad de Valencia - CSIC, Valencia and  
Instituto de Microelectrónica de Barcelona, Bellaterra, Barcelona

**Sweden**

Fysiska Institutionen, Lunds universitet, Lund  
Royal Institute of Technology (KTH), Stockholm  
University of Stockholm, Stockholm  
Uppsala University, Department of Radiation Sciences, Uppsala

**Switzerland**

Laboratory for High Energy Physics, University of Bern, Bern  
Section de Physique, Université de Genève, Geneva

**Taiwan**

Institute of Physics, Academia Sinica, Taipei

**Turkey**

Department of Physics, Ankara University, Ankara  
Department of Physics, Bogazici University, Istanbul

**United Kingdom**

School of Physics and Astronomy, The University of Birmingham, Birmingham  
Cavendish Laboratory, Cambridge University, Cambridge  
Department of Physics and Astronomy, University of Glasgow, Glasgow  
Department of Physics, Lancaster University, Lancaster  
Department of Physics, Oliver Lodge Laboratory, University of Liverpool, Liverpool  
Department of Physics, Queen Mary and Westfield College, University of London, London  
Department of Physics, Royal Holloway and Bedford New College, Egham  
Department of Physics and Astronomy, University College London, London  
Department of Physics and Astronomy, University of Manchester, Manchester  
Department of Physics, Oxford University, Oxford  
Rutherford Appleton Laboratory, Chilton, Didcot  
Department of Physics, University of Sheffield, Sheffield

#### United States of America

State University of New York at Albany, New York  
Argonne National Laboratory, Argonne, Illinois  
University of Arizona, Tucson, Arizona  
Department of Physics, The University of Texas at Arlington, Arlington, Texas  
Lawrence Berkeley Laboratory and University of California, Berkeley, California  
Physics Department of the University of Boston, Boston, Massachusetts  
Brandeis University, Department of Physics, Waltham, Massachusetts  
Brookhaven National Laboratory (BNL), Upton, New York  
University of Chicago, Enrico Fermi Institute, Chicago, Illinois  
Nevis Laboratory, Columbia University, Irvington, New York  
Department of Physics, Duke University, Durham, North Carolina  
Department of Physics, Hampton University, Virginia  
Department of Physics, Harvard University, Cambridge, Massachusetts  
Indiana University, Bloomington, Indiana  
Iowa State University, Ames, Iowa  
University of California, Irvine, California  
Massachusetts Institute of Technology, Department of Physics, Cambridge, Massachusetts  
Michigan State University, Department of Physics and Astronomy, East Lansing, Michigan  
University of Michigan, Department of Physics, Ann Arbor, Michigan  
Department of Physics, New Mexico University, Albuquerque, New Mexico  
Northern Illinois University, DeKalb, Illinois  
Ohio State University, Columbus, Ohio  
Department of Physics and Astronomy, University of Oklahoma  
Department of Physics, University of Pennsylvania, Philadelphia, Pennsylvania  
University of Pittsburgh, Pittsburgh, Pennsylvania  
Department of Physics and Astronomy, University of Rochester, Rochester, New York  
Institute for Particle Physics, University of California, Santa Cruz, California  
Department of Physics, Southern Methodist University, Dallas, Texas  
State University of New York at Stony Brook, New York  
Tufts University, Medford, Massachusetts  
High Energy Physics, University of Illinois, Urbana, Illinois  
Department of Physics, Department of Mechanical Engineering, University of Washington, Seattle, Washington  
Department of Physics, University of Wisconsin, Madison, Wisconsin

## Acknowledgements

The authors would like to thank Mario Ruggier for preparing the template upon which this document is based and the DocSys group for their help in using it.

# Contents

ATLAS Collaboration . . . . .	iii
Acknowledgements . . . . .	viii
<b>Part 1</b>	
Global View . . . . .	1
<b>1 Overview . . . . .</b>	<b>3</b>
1.1 Document overview . . . . .	3
1.2 Main system requirements . . . . .	4
1.2.1 Rate requirements and event-selection strategy . . . . .	4
1.2.2 Detector readout requirements . . . . .	5
1.2.3 Functional and operational requirements . . . . .	5
1.2.4 Requirements due to the long expected lifetime of ATLAS . . . . .	6
1.3 System components and functions . . . . .	6
1.3.1 The Data Flow system . . . . .	7
1.3.1.1 ROD-grate data acquisition . . . . .	8
1.3.2 The High Level Trigger system . . . . .	8
1.3.3 The Online software system . . . . .	9
1.3.4 The Detector Control system . . . . .	9
1.4 Data types . . . . .	10
1.5 Long-term issues and perspectives . . . . .	11
1.6 Glossary . . . . .	12
1.7 References . . . . .	13
<b>2 Parameters . . . . .</b>	<b>15</b>
2.1 Detector readout parameters . . . . .	15
2.2 Trigger and DataFlow parameters . . . . .	18
2.3 Monitoring requirements . . . . .	20
2.4 Calibration requirements . . . . .	20
2.5 DCS parameters . . . . .	21
2.6 References . . . . .	23
<b>3 System Operations . . . . .</b>	<b>25</b>
3.1 Introduction . . . . .	25
3.2 TDAQ states . . . . .	25
3.3 The run . . . . .	26
3.3.1 Run definition . . . . .	26
3.3.2 Run Identification . . . . .	27
3.3.3 Event identification . . . . .	27
3.3.4 Performance requirement . . . . .	27
3.3.5 Categories of runs . . . . .	28
3.3.6 Operations during a Run . . . . .	29
3.3.7 Transition between Runs . . . . .	29

3.4 Partitions and related operations . . . . .	31
3.5 Operations outside a run . . . . .	33
3.6 Error handling strategy . . . . .	33
3.7 Data bases . . . . .	34
3.8 References . . . . .	34
<b>4 Physics selection strategy . . . . .</b>	<b>37</b>
4.1 Requirements . . . . .	37
4.2 Selection criteria . . . . .	38
4.3 Physics objects for event selection . . . . .	39
4.4 Trigger menu . . . . .	41
4.4.1 Physics triggers . . . . .	42
4.4.2 Prescaled physics triggers . . . . .	43
4.4.3 Exclusive physics triggers . . . . .	44
4.4.4 Monitor and calibration triggers . . . . .	45
4.4.5 Physics coverage . . . . .	46
4.5 Adapting to changes in running conditions . . . . .	47
4.6 Determination of trigger efficiencies . . . . .	48
4.7 References . . . . .	50
<b>5 Architecture . . . . .</b>	<b>51</b>
5.1 TDAQ context . . . . .	51
5.2 HLT/DAQ functional analysis . . . . .	51
5.2.1 Functional decomposition . . . . .	52
5.2.2 HLT/DAQ building blocks . . . . .	53
5.2.3 HLT/DAQ Interfaces . . . . .	54
5.2.3.1 Interfaces to other parts of ATLAS . . . . .	55
5.2.3.1.1 LV1-LV2 trigger interface . . . . .	55
5.2.3.1.2 Detector specific triggers . . . . .	55
5.2.3.1.3 Interface to the detector front-ends . . . . .	56
5.2.3.1.4 TDAQ access to the Conditions Databases . . . . .	56
5.2.3.1.5 Mass Storage . . . . .	56
5.2.3.2 External interfaces . . . . .	57
5.2.3.2.1 Interface to the LHC machine, safety systems and the CERN technical infrastructure . . . . .	57
5.3 Architecture of the HLT/DAQ system . . . . .	57
5.3.1 Architectural components . . . . .	58
5.3.1.1 Detector readout . . . . .	58
5.3.1.2 LV12 . . . . .	59
5.3.1.3 Event Builder . . . . .	60
5.3.1.4 Event Filter . . . . .	60
5.3.1.5 Online software system . . . . .	61
5.3.1.6 Detector Control System . . . . .	62
5.3.2 Overall experimental control . . . . .	62
5.4 Partitioning . . . . .	63
5.5 Implementation of the architecture . . . . .	64
5.5.1 Overview . . . . .	64

5.5.2	Categories of components . . . . .	67
5.5.3	Custom Components . . . . .	67
5.5.3.1	The ELMB . . . . .	67
5.5.3.2	The ReadOut Link . . . . .	67
5.5.3.3	The ROBIN . . . . .	67
5.5.3.4	The Region-of-Interest Builder . . . . .	68
5.5.4	ReadOut System . . . . .	68
5.5.5	Networks . . . . .	69
5.5.6	Supervisory Components. . . . .	70
5.5.7	HLT processors . . . . .	70
5.5.8	Event-Building processors . . . . .	71
5.5.9	Mass storage . . . . .	71
5.5.10	Online Farm . . . . .	71
5.5.11	Deployment . . . . .	72
5.6	Scalability and Staging . . . . .	72
5.7	References . . . . .	74
<b>6</b>	<b>Fault tolerance and error handling . . . . .</b>	<b>77</b>
6.1	Fault-tolerance and error-handling strategy . . . . .	77
6.2	Error definition and identification . . . . .	78
6.3	Error-reporting mechanism . . . . .	78
6.4	Error diagnosis and system-status verification . . . . .	79
6.5	Error recovery . . . . .	79
6.6	Error logging and error browsing . . . . .	80
6.7	Data integrity . . . . .	80
6.8	Fault-tolerance and failure strategy for hardware components . . . . .	81
6.8.1	The source end of Readout Links . . . . .	81
6.8.2	The Readout System . . . . .	81
6.8.3	The RoI Builder . . . . .	82
6.8.4	Network . . . . .	82
6.8.5	Rack-mounted PCs . . . . .	83
6.9	Use Cases. . . . .	84
6.10	References . . . . .	85
<b>7</b>	<b>Monitoring . . . . .</b>	<b>87</b>
7.1	Overview. . . . .	87
7.2	Monitoring sources . . . . .	87
7.2.1	DAQ data flow monitoring . . . . .	87
7.2.1.1	Front-end and ROD monitoring . . . . .	87
7.2.1.2	Data Collection monitoring . . . . .	88
7.2.2	Trigger monitoring. . . . .	88
7.2.2.1	Trigger decision. . . . .	88
7.2.2.1.1	LVL1 decision . . . . .	88
7.2.2.1.2	LVL2 decision . . . . .	88
7.2.2.1.3	EF decision . . . . .	88
7.2.2.1.4	Classification monitoring . . . . .	89

7.2.2.1.5	Physics monitoring . . . . .	89
7.2.2.2	Operational monitoring . . . . .	89
7.2.2.2.1	LVL1 operational monitoring. . . . .	89
7.2.2.2.2	LVL2 operational monitoring. . . . .	90
7.2.2.2.3	EF operational monitoring. . . . .	90
7.2.2.2.4	PESA SW operational monitoring . . . . .	91
7.2.3	Network monitoring . . . . .	91
7.2.4	Detector monitoring . . . . .	92
7.3	Tools for monitoring. . . . .	93
7.3.1	Online Software services. . . . .	94
7.3.2	Computing resources for monitoring . . . . .	94
7.3.2.1	Workstations In SCXI . . . . .	94
7.3.2.2	Monitoring in the Event Filter . . . . .	94
7.3.2.3	Monitoring after the Event Filter . . . . .	95
7.3.2.4	Network requirements . . . . .	95
7.3.2.5	A monitoring matrix is presented in Network requirements . . . . .	95
7.4	Archiving monitoring data . . . . .	96
7.5	References . . . . .	96
<b>Part 2</b>	<b>System Components . . . . .</b>	<b>97</b>
<b>8</b>	<b>Data-flow . . . . .</b>	<b>99</b>
8.1	Detector readout and event fragment buffering . . . . .	99
8.1.1	ROD grate data acquisition . . . . .	99
8.1.2	ReadOut link . . . . .	100
8.1.3	ReadOut subsystem . . . . .	102
8.1.3.1	High Level Design . . . . .	102
8.1.3.2	Design of the Robin . . . . .	104
8.1.3.3	Implementation and performance of the ROS . . . . .	105
8.1.3.4	pROS . . . . .	109
8.2	Boundary and interface to the LVL1 trigger . . . . .	109
8.2.1	Region-of-interest builder . . . . .	111
8.2.1.1	Implementation and performance . . . . .	111
8.3	Control and flow of event data to high level triggers. . . . .	112
8.3.1	Message passing . . . . .	112
8.3.1.1	Control and event data messages. . . . .	112
8.3.1.2	Ethernet . . . . .	114
8.3.1.2.1	Basic switch performance . . . . .	115
8.3.1.2.2	Virtual Local Area Network . . . . .	116
8.3.1.3	Design of the message passing component . . . . .	117
8.3.1.4	Performance of the message passing. . . . .	118
8.3.2	Data collection . . . . .	119
8.3.2.1	General overview. . . . .	119

8.3.2.1.1	OS Abstraction Layer	120
8.3.2.1.2	Error Reporting	120
8.3.2.1.3	Configuration Database	120
8.3.2.1.4	System Monitoring	120
8.3.2.1.5	Run Control	121
8.3.2.2	Raw data collection	121
8.3.2.2.1	Design	121
8.3.2.2.2	Performance	121
8.3.2.3	Event Building	122
8.3.2.3.1	Design	122
8.3.2.3.2	Performance	124
8.3.2.3.3	Event Building with QoS	125
8.4	Scalability	128
8.4.1	Detector readout channels	128
8.4.1.1	Control and flow of event data	128
8.4.1.2	Configuration and control	128
8.4.2	LVL1 rate	128
8.5	References	129
<b>9</b>	<b>High-level trigger</b>	<b>131</b>
9.1	HLT overview	131
9.2	LVL2	133
9.2.1	Overview	133
9.2.2	RoI Builder	133
9.2.3	LVL2 Supervisor	133
9.2.4	LVL2 Processors	134
9.2.4.1	L2PU	134
9.2.4.2	PESA Steering Controller (PSC)	135
9.2.4.3	Interfaces with the Event Selection Software	138
9.2.5	pROS	138
9.3	Event Filter	139
9.3.1	Overview	139
9.3.2	Event Handler	139
9.3.2.1	Overview	139
9.3.2.2	Event Filter Dataflow	140
9.3.2.3	Processing Task	142
9.3.2.3.1	Interfaces with Event Selection Software	143
9.3.2.4	Detailed EF Validation tests	144
9.3.2.4.1	EF data flow stand-alone performances	144
9.3.2.4.2	EF data flow communication with main DataFlow	144
9.3.2.4.3	Robustness tests	146
9.4	HLT operation	146
9.4.1	Common aspects	146
9.4.2	LVL2 operation	147
9.4.3	EF operation	147

9.5	Event Selection Software (ESS)	148
9.5.1	Overview	148
9.5.2	The Event Data Model sub-package	150
9.5.3	The HLT algorithms sub-package	150
9.5.3.1	The seeding mechanism	151
9.5.4	The steering sub-package	152
9.5.4.1	Implementation of the steering	153
9.5.4.2	The Trigger Configuration	154
9.5.4.3	The LVL1 conversion	155
9.5.4.4	The Step Handler	156
9.5.4.5	The Result Builder and the LVL2 Conversion	157
9.5.4.6	The Steering Monitoring	158
9.5.5	The Data Manager sub-package	158
9.5.5.1	Implementation	158
9.5.5.2	The Raw Data Access	159
9.6	Conclusions	161
9.7	References	161
<b>10</b>	<b>Online Software</b>	<b>163</b>
10.1	Introduction	163
10.2	The architectural model	164
10.3	Information sharing	164
10.3.1	Functionality of the Information Sharing Services	165
10.3.1.1	Types of shared information	165
10.3.2	Performance and scalability requirements on Information Sharing	166
10.3.3	Architecture of Information Sharing services	167
10.3.3.1	Information Service	167
10.3.3.2	Error Reporting Service	168
10.3.3.3	Online Histogramming Service	168
10.3.3.4	Event Monitoring Service	169
10.3.3.5	Relation between Information Sharing services	170
10.3.4	Prototype evaluation	170
10.3.4.1	Description of the current implementation	170
10.3.4.2	Performance and scalability of current implementation	171
10.3.4.3	Usage of Information Sharing services by the TDAQ sub-systems	172
10.4	Databases	172
10.4.1	Functionality of the databases	172
10.4.1.1	Configuration Databases	173
10.4.1.2	Online Bookkeeper	173
10.4.1.3	Conditions Database interfaces	173
10.4.2	Performance and scalability requirements on the databases	173
10.4.3	Architecture of databases	174
10.4.3.1	Configuration Databases	174
10.4.3.2	Online Bookkeeper	175

10.4.3.3	Conditions Database Interface . . . . .	176
10.4.4	Prototype evaluation . . . . .	177
10.4.4.1	Scalability and performance tests of the Configuration Databases . . . . .	177
10.4.4.2	Online Bookkeeper . . . . .	178
10.5	Control . . . . .	178
10.5.1	Control functionality . . . . .	178
10.5.2	Performance and scalability requirements on Control . . . . .	179
10.5.3	Control architecture . . . . .	179
10.5.3.1	User Interface . . . . .	179
10.5.3.2	Supervision . . . . .	179
10.5.3.3	Verification . . . . .	180
10.5.3.4	Process, Access and Resource Management systems . . . . .	181
10.5.4	Prototype evaluation . . . . .	182
10.5.4.1	Scalability and performance tests . . . . .	183
10.5.4.2	Technology considerations . . . . .	183
10.6	Integration tests . . . . .	184
10.6.1	Online Software Integration and large-scale performance tests . . . . .	184
10.6.2	Event Filter Software tests involving the Online Software . . . . .	185
10.6.3	Deployment in test beam . . . . .	186
10.7	References . . . . .	186
<b>11</b>	<b>DCS . . . . .</b>	<b>189</b>
11.1	Introduction . . . . .	189
11.2	Organization of the DCS . . . . .	189
11.3	Front-End system . . . . .	190
11.3.1	Embedded local monitor board . . . . .	191
11.3.2	Other FE equipment . . . . .	191
11.4	The Back-End system . . . . .	192
11.4.1	Functional hierarchy . . . . .	192
11.4.2	SCADA . . . . .	194
11.4.3	PVSS-II . . . . .	194
11.4.4	PVSS-II framework . . . . .	194
11.5	Integration of Front-end and Back-end . . . . .	195
11.5.1	OPC CANopen server . . . . .	196
11.6	Read-out chain . . . . .	196
11.6.1	Performance of the DCS readout chain . . . . .	197
11.6.2	Long term operation of the read-out chain . . . . .	198
11.7	Applications . . . . .	199
11.8	Connection to DAQ . . . . .	199
11.8.1	Data transfer facility (DDC-DT) . . . . .	200
11.8.2	Message transfer facility (DDC-MT) . . . . .	201
11.8.3	Command transfer facility (DDC-CT) . . . . .	201
11.9	Interface to External Systems . . . . .	202
11.9.1	LHC . . . . .	202
11.9.2	Magnet system . . . . .	203

11.9.3	CERN technical services . . . . .	203
11.9.4	Detector Safety System . . . . .	203
11.10	References . . . . .	203
<b>12</b>	<b>Experiment Control . . . . .</b>	<b>205</b>
12.1	Introduction . . . . .	205
12.2	Detector control . . . . .	205
12.3	TDQA Control . . . . .	206
12.3.1	Control of the DataFlow . . . . .	208
12.3.2	HLT farm supervision . . . . .	208
12.4	Control coordination . . . . .	209
12.4.1	Operation of the LHC machine . . . . .	210
12.4.2	Detector states . . . . .	210
12.4.3	Operation of the TDQA states . . . . .	211
12.4.4	Inter- relation of states . . . . .	212
12.5	Control Scenarios . . . . .	213
12.5.1	Operational Data-taking Phases . . . . .	214
12.5.1.1	Initialisation . . . . .	214
12.5.1.2	Preparation . . . . .	214
12.5.1.3	Data-taking . . . . .	215
12.5.1.4	Stopping . . . . .	216
12.5.1.5	Shut-down . . . . .	216
12.5.2	Control of a Physics Run . . . . .	216
12.5.3	Calibration Run . . . . .	217
12.5.4	Operation outside a Run . . . . .	218
12.6	References . . . . .	219
<b>Part 3</b>	<b>System Performance . . . . .</b>	<b>221</b>
<b>13</b>	<b>Physics selection and HLT performance . . . . .</b>	<b>223</b>
13.1	Introduction . . . . .	223
13.2	The LVL1 trigger simulation . . . . .	224
13.2.1	Configuration of the LVL1 trigger . . . . .	225
13.2.2	The calorimeter trigger and its simulation . . . . .	227
13.2.3	The RPC muon trigger and its simulation . . . . .	228
13.2.4	The Muon-to-CTP interface and its simulation . . . . .	229
13.2.5	The LVL1 CTP and its simulation . . . . .	230
13.2.6	Interface to the HLT . . . . .	231
13.3	Common tools for selection . . . . .	231
13.3.1	Algorithmic View of the Core Software Framework . . . . .	231
13.3.2	Event Data Model Components . . . . .	232
13.3.2.1	Event Data Organization . . . . .	232
13.3.2.2	Raw Data Model Components . . . . .	233
13.3.2.3	Reconstruction Data Model Components . . . . .	233



13.3.2.3.1	Inner Detector	.234
13.3.2.3.2	Calorimeters	.235
13.3.2.3.3	Muon Spectrometer	.235
13.3.2.4	Reconstruction Output	.235
13.3.2.4.1	Tracks	.235
13.3.2.4.2	Calorimeter Clusters	.236
13.3.3	HLT Algorithms for LVL2	.236
13.3.3.1	IDSCAN	.236
13.3.3.2	SITrack	.236
13.3.3.3	TRTLUT	.237
13.3.3.4	TRTKalman	.238
13.3.3.5	T2Calo	.238
13.3.3.6	muFast	.239
13.3.3.7	muComb	.240
13.3.4	HLT Algorithms for EF	.240
13.3.4.1	xKalman++	.240
13.3.4.2	iPatRec	.242
13.3.4.3	LArClusterRec	.242
13.3.4.4	egammaRec	.242
13.3.4.5	Moore	.243
13.4	Signatures, rates and efficiencies	.243
13.4.1	$e/\gamma$	.244
13.4.1.1	HLT Electron Selection Performance	.245
13.4.1.2	HLT Electron/Photon Algorithm Optimization	.246
13.4.1.3	HLT Strategy and the LVL2-EF Boundary	.247
13.4.2	Muon selection	.248
13.4.2.1	The Physics Performances of LVL2 Muon algorithms	.248
13.4.2.2	The Physics Performances of the Muon Event Filter	.249
13.4.2.3	The Timing Performances of the Muon Algorithms	.249
13.4.3	Tau/jets/ $E_{miss}$	.250
13.4.3.1	The First Level Tau Trigger	.250
13.4.3.2	The Second Level Tau Trigger	.251
13.4.3.3	Tau Selection in the Event Filter	.252
13.4.4	b-tagging	.253
13.4.4.1	b-tagging at LVL2	.253
13.4.4.2	Results on single b-jet tagging	.254
13.4.4.3	Comparison with Offline b-tagging	.254
13.4.5	B-physics	.255
13.4.5.1	Di-muon triggers	.256
13.4.5.2	Hadronic final states	.256
13.4.5.3	Muon-electron final states	.257
13.4.5.4	Resource estimates	.258
13.5	Event rates and size to off-line	.259
13.6	Start-up scenario	.259
13.7	References	.259

<b>14</b>	<b>Overall system performance and validation</b>	<b>.263</b>
14.1	Introduction	.263
14.2	Integrated Prototypes	.263
14.2.1	System performance of event selection	.263
14.2.1.1	Measurement and validation strategy	.263
14.2.1.2	Event selection at LVL2	.264
14.2.1.3	Event selection at the Event Filter	.266
14.2.1.3.1	The Event Filter Processing Task	.266
14.2.1.3.2	Event Filter Prototype	.268
14.2.1.4	The HLT vertical slice	.269
14.2.2	The 10% prototype	.270
14.2.2.1	Description of the 10% testbed	.270
14.2.2.2	Description of measurements	.271
14.2.2.3	Results	.272
14.3	Functional tests and test beam	.273
14.4	Paper model	.274
14.5	Computer model	.275
14.5.1	Results of testbed models	.276
14.5.2	Results of extrapolation of testbed model and identification of problem areas	.276
14.5.2.1	Load balancing	.277
14.5.2.2	Congestion in switches and buffer sizes	.278
14.5.2.3	Spare processor capacity and spare network bandwidth	.279
14.6	Technology tracking	.279
14.6.1	Status and Prospects	.279
14.6.1.1	The personal computer market	.279
14.6.1.2	Operating systems	.279
14.6.1.3	PC Buses	.280
14.6.1.4	Networking	.280
14.6.2	Survey of non-ATLAS solutions	.281
14.7	Implication of staging scenarios	.282
14.8	Areas of concern	.283
14.9	Conclusions	.283
14.10	References	.283
<b>Part 4</b>	<b>Organisation and Plan</b>	<b>.285</b>
<b>15</b>	<b>Quality assurance and development process</b>	<b>.287</b>
15.1	Quality assurance in TDAQ	.287
15.2	Hardware development and procurement	.287
15.2.1	Reviews	.287
15.2.2	Testing	.288
15.3	The Software Development Process	.289
15.3.1	Inspection and Review	.289

15.3.2	Experience . . . . .	. 290
15.3	The development phases . . . . .	. 290
15.3.3.1	Requirements . . . . .	. 290
15.3.3.2	Architecture and Design . . . . .	. 291
15.3.3.3	Implementation . . . . .	. 291
15.3.3.4	Component and Integration Testing . . . . .	. 292
15.3.3.5	Maintenance . . . . .	. 292
15.3.4	The Development Environment . . . . .	. 292
15.4	Quality Assurance during deployment . . . . .	. 293
15.4.1	Quality Assurance from early deployment . . . . .	. 293
15.4.2	Quality Assurance of operations during data taking . . . . .	. 293
15.5	References . . . . .	. 294
<b>16</b>	<b>Costing . . . . .</b>	<b>. 295</b>
16.1	System evolution and staging . . . . .	. 295
16.2	Costing of components . . . . .	. 296
16.3	Categories of expenditures . . . . .	. 296
16.4	Expenditure profile and system cost . . . . .	. 297
16.5	References . . . . .	. 298
<b>17</b>	<b>Organization and resources . . . . .</b>	<b>. 299</b>
17.1	Project organization . . . . .	. 299
17.2	Resources . . . . .	. 301
17.2.1	HLT/DAQ resources . . . . .	. 301
17.3	References . . . . .	. 301
<b>18</b>	<b>Workplan and schedule . . . . .</b>	<b>. 303</b>
18.1	Schedule . . . . .	. 303
18.1.1	System hardware . . . . .	. 303
18.1.2	System software . . . . .	. 303
18.2	Post-TDR workplan . . . . .	. 305
18.2.1	DataFlow workplan . . . . .	. 306
18.2.2	High-Level Trigger workplan . . . . .	. 306
18.2.3	Detector Control System workplan . . . . .	. 307
18.2.3.1	Front-End . . . . .	. 307
18.2.3.2	Back-End . . . . .	. 307
18.2.4	Other issues to be addressed . . . . .	. 308
18.3	Commissioning . . . . .	. 309
18.3.1	Tools for detector commissioning . . . . .	. 309
18.3.1.1	ROD-Crate DAQ . . . . .	. 309
18.3.1.2	Readout of multiple ROD crates . . . . .	. 310
18.3.1.3	Readout of multiple sub-detectors . . . . .	. 310
18.4	References . . . . .	. 311
<b>A</b>	<b>Paper model results . . . . .</b>	<b>. 313</b>
A.1	LVL1 trigger menu . . . . .	. 313
A.2	Event fragment sizes . . . . .	. 313

A.3	Parameters relevant for LVL2 processing . . . . .	. 314
A.4	Parameters relevant for Event Builder and Event Filter . . . . .	. 316
A.5	Data rate summaries . . . . .	. 316
A.6	Overview of paper model results . . . . .	. 318
<b>B</b>	<b>Glossary . . . . .</b>	<b>. 321</b>
B.1	Acronyms . . . . .	. 321
B.2	Definitions . . . . .	. 326
<b>C</b>	<b>Participating Institutes . . . . .</b>	<b>. 331</b>
C.1	Authors from participating institutes . . . . .	. 331
C.2	Authors from non participating institutes . . . . .	. 334

# Part 1

## Global View

# 1 Overview

## 1.1 Document overview

This Technical Design Report (TDR) for the High Level Trigger (HLT), Data Acquisition (DAQ) and Controls of the ATLAS experiment builds on the earlier documents published on these systems: Trigger Performance Status Report [1-1], DAQ, EF, LVL2 and DCS Technical Progress Report [1-2], and HLT/DAQ/DCS Technical Proposal [1-3]. Much background and preparatory work relevant to this TDR is referenced in the above documents. In addition, a large amount of detailed technical documentation has been produced in support of this TDR. These documents are referenced in the appropriate places in the following chapters.

This section introduces the overall organization of the document. The following sections give an overview of the principal system requirements and functions, as well as a brief description of the principal data types used in the TDAQ system.

The document has been organized into four parts:

- Part I — Global View  
Chapters 2, 3 and 4 address the principal system and experiment parameters which define the main requirements of the HLT, DAQ and Controls system. The global system operations, and the physics requirements and event selection strategy are also addressed. Chapter 5 defines the overall architecture of the system and analyses the requirements of its principal components while Chapters 6 and 7 address more specific fault-tolerance and monitoring issues.
- Part II — System Components  
This part describes in more detail the principal components and functions of the system. Chapter 8 addresses the final prototype design and performance of the Data Flow component. These are responsible for the transport of event data from the output of the detector Read Out Links (ROLS) via the HLT system (where event selection takes place) to mass storage. Chapter 9 explains the decomposition of the HLT into a second level trigger (LVL2) and an Event Filter (EF) component. It details the design of the data flow within the HLT, the specifics of the HLT system supervision, and the design and implementation of the HLT event selection software framework. Chapter 10 addresses the Online Software which is responsible for the run control and DAQ supervision of the entire Trigger/DAQ (TDAQ) and detector systems during data taking. It is also responsible for miscellaneous services such as error reporting, run parameter accessibility, and histogramming and monitoring support. Chapter 11 describes the Detector Control System (DCS), responsible for the control and supervision of all the detector hardware and of the services and the infrastructure of the experiment. The DCS is also the interface point for information exchange between ATLAS and the LHC accelerator. Chapter 12 draws together the various aspects of experiment control detailed in previous chapters and examines several use-cases for the overall operation and control of the experiment, including: data-taking operations, calibration runs, and operations required outside data-taking.

- Part III — System Performance

Chapter 13 addresses the physics selection and performance. The tools used for physics selection are described along with the event-selection algorithms and their performance.

Overall HLT output rates and sizes are also discussed. A first analysis of how ATLAS will handle the first year of running from the point of view of event selection is presented assuming a specific machine start-up scenario. Chapter 14 discusses the overall performance of the TDAQ system from various points of view, namely the HLT performance as evaluated in dedicated testbeds, the overall performance of the TDAQ system in a testbed of ~10% ATLAS size, and functional tests of the system in the detector test-beam environment. Data from these various testbeds are also used to calibrate a detailed discrete-event-simulation model of data flow in the full-scale system.

- Part IV — Organization and Planning  
Chapter 15 discusses quality-assurance issues and explains the software-development process employed. Chapter 16 presents the system costing and staging scenarios. Chapter 17 presents the overall organization of the project and general system-resource issues. Chapter 18 presents the TDAQ work-plan for the next phase of the project up to LHC turn-on in 2007.

## 1.2 Main system requirements

This section presents some of the principal requirements on the TDAQ system from several points of view. The response to these requirements in terms of the system design is then presented in the later chapters of the document.

### 1.2.1 Rate requirements and event-selection strategy

The LHC proton bunches will cross at a frequency of 40 MHz. At the machine's design luminosity of  $1 \times 10^{34} \text{ cm}^{-2} \text{ s}^{-1}$ , on average about 23 inelastic proton-proton collisions will be produced at each bunch crossing. The level-1 trigger (LVL1) [1-4] will make the first level of event selection, reducing the initial event rate to less than about 75 kHz. Operation at up to about 100 kHz is possible with somewhat increased deadline. The HLT must reduce the event rate further to O(100) Hz. Each selected event will have a total size of ~1.5 Mbyte giving a required storage capability of a few hundred Mbyte/s.

The ATLAS baseline assumes a maximum LVL1 rate of 75 kHz. However, for the purposes of the system design and costing, a maximum LVL1 rate of 100 kHz has been assumed in this document, in order to ensure that if ATLAS decides to run at this LVL1 rate, that the HLT/DAQ system will be able to handle it.

ATLAS aims to use inclusive triggers as much as possible in its physics-selection strategy in order to maximise its physics coverage and to be as open as possible to new and possibly unforeseen signatures. The configuration of the entire trigger system, including LVL1, must be sufficiently flexible that one can easily change both algorithms and their thresholds between data-taking runs. The system also needs to be able to respond rapidly to the consequences of changes in the beam conditions in terms of performance and stability.

## 1.2.2 Detector readout requirements

The TDAQ system is required to handle data coming in parallel from the detector readout drivers (RODs) over some 1600 point-to-point readout links (ROLS), each having a maximum bandwidth of 160 Mbyte/s. Taking into account estimates of the bandwidth that will be used by each detector, the total readout bandwidth to be dealt with after the LVL1 trigger is more than ~160 Gbyte/s. This number depends on the detector occupancy as well as the LVL1 trigger rate and will vary considerably according to the luminosity being delivered by the LHC. Other important aspects bearing on the total readout bandwidth are the data compression and zero suppression schemes which are still under study in some of the detector systems. A more detailed description of the parameters of the detectors' readout systems, their readout data bandwidths and channel occupancies can be found in Chapter 2.

## 1.2.3 Functional and operational requirements

The TDAQ system must be designed and constructed in such a way as to provide ATLAS with highly reliable and efficient data-taking and event-selection capabilities. The huge investment in both financial and human resources for the ATLAS detector itself, and also for the LHC machine, means that data-taking operations must be established and optimized as soon as possible after first collisions in the LHC in 2007, in order to capitalize on this investment.

From early stages in the development of the ATLAS TDAQ system, elements of the system (in particular those concerned with data acquisition) have been used and tested in a test beam environment, providing the data acquisition functionality and performance needed for the detector data taking. A major effort has been made to minimize the functional divergence between the system used at the test beam and that being developed for the final experiment. Apart from providing a real-life, albeit scaled down, testing facility for the TDAQ system, this policy has the advantage of familiarizing the detector communities in ATLAS with the TDAQ system at an early stage. Some of the elements of the TDAQ system (those closest to the detector readout, and their associated control and supervision functions) will be required by the detectors during their commissioning phases, both above and below ground. Requiring that the detectors be able to use and give feedback on the TDAQ system well in advance of this, therefore offers considerable advantages both to the TDAQ and to the detector communities in terms of easing the installation and commissioning phase of the experiment.

An essential requirement on the TDAQ system which will be particularly important in the commissioning and installation phase is the ability to partition the system into several independent but fully-functional entities. It must be possible for several detectors and/or several parts of a given detector to be triggered and to take data in parallel and independently of each other. This is in order to facilitate and render as parallel as possible the detector debugging and commissioning operations. During physics running, it will be necessary to have the capability to run a partition of an element of a given detector in test mode, to help track down a fault, while the rest of the ATLAS detector is taking data normally.

The DCS is an integral part of the TDAQ system and assumes a particular role in assuring the coherent, safe operation and monitoring of all components of the ATLAS detector. Although it is highly integrated with other parts of the TDAQ system, the DCS has the particular requirements of being operational 24 hours a day, seven days a week and of being highly fault tolerant. The principal elements of the DCS must be installed and commissioned in time for the first detector commissioning operations which will begin in early 2005. These elements must be able to

operate in a stand-alone mode i.e. without depending on other parts of the TDAQ system being available.

Constraints of floor space and cooling capacity, in particular in the experiment's underground cavern and adjoining service rooms, limit the number of racks available to the TDAQ system. The proposed location of the HLT/DAQ racks is presented in Section 5.5.11.

## 1.2.4 Requirements due to the long expected lifetime of ATLAS

The installation and commissioning phase of ATLAS [1-5] will take in excess of four years and the experiment is expected to take data for fifteen years or more. This timescale puts a strong premium on the requirement for a highly modular and cost-effective system design. This facilitates the replacement or upgrading of specific elements of the system in a manner that will have little or no side effects on neighbouring elements.

Experience has shown that custom electronics is more difficult and expensive to maintain in the long term than comparable commercial products. The use of commercial computing and network equipment, and the adoption of commercial protocol standards such as Ethernet, wherever appropriate and possible, is a requirement which will help us to maintain the system for the full lifetime of the experiment. The adoption of widely-supported commercial standards and equipment at the outset will also enable us to benefit from future improvements in technology by rendering equipment replacement and upgrade relatively transparent. An additional benefit of such an approach is the highly-competitive commercial market which offers high performance at low cost.

## 1.3 System components and functions

In this section, the principal components and functions of the baseline HLT/DAQ system are described very briefly in order to give the reader an overview of the system before proceeding to the subsequent chapters where detailed descriptions are given. A schematic diagram is presented in Figure 1-1. HLT/DAQ can be broken down into four principal systems, namely:

- The Data Flow system — responsible for receiving the detector data, serving of a subset of data to the HLT system, and transporting the data for selected events to mass storage
- The HLT system — responsible for the post-LVL1 event selection and filtering involving a rate reduction of a factor of several hundred, and for the classification of all accepted events
- The Online system — responsible for all aspects of experiment and TDAQ operation and control during data-taking, and during testing and calibration runs
- The DCS — responsible for the coherent and safe operation of the ATLAS detector, as well as the interface with external systems and services including the LHC itself

The Online system is implicitly understood to be connected to all elements in Figure 1-1, and the DCS to all hardware elements which need to be monitored and controlled.

### 1.3.1 The Data Flow system

ATLAS decided early on to define the boundary between the detector readout and the data acquisition to be at the input of the Read Out Buffers (ROBs) [1-6]. The ROIs, for which there is an agreed ATLAS standard, transport data fragments of LVL1-accepted events from the detectors' RODs to the ROBs. The Read Out Systems (ROS's) each contain several ROBs.

Requested data fragments from selected ROBs are served to the LVL2 trigger element of the HLT system. Event data fragments for LVL2-accepted events are then built, on the initiation of the Data Flow Manager (DFM), from the ROBs, across a switched Ethernet network, into a complete event by one of the ~100 Sub-Farm Interfaces (SFIs). The SFIs then serve the complete event to the second element of the HLT system, the Event Filter (EF). Events selected by the EF for final archiving in preparation for offline reconstruction and primary analysis are passed to permanent storage via the final element of the Data Flow system, the Sub-Farm Output (SFO).

Most of the element interconnection in the Data Flow system is done using standard Gigabit Ethernet network and switching technology. The maximum network bandwidth capacity required for building events accepted by the LVL2 trigger is expected to be ~5 Gbyte/s, much less than the aggregate data rate into the RODs for events retained by LVL1.

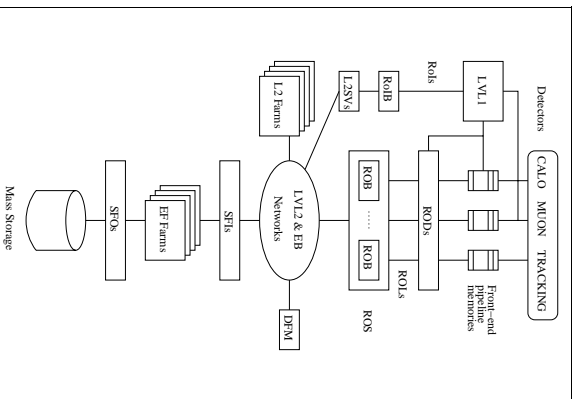

Figure 1-1 Principal components of the data-flow and HLT systems

#### 1.3.1.1 ROD-crate data acquisition

The detector ROD crates contain a variety of modules, including: the RODs themselves, modules used for control of the Front-end Electronics and for processing event data upstream of the RODs, as well as one or more ROD Crate Processors (RCPs). They may also contain reduced-functionality ROD prototypes in laboratory setups or at test beams. Each ROD Crate is connected by a local-area Ethernet network to one or more ROD Crate Workstations (RCWs).

The detector communities need common DAQ functionality at the level of the ROD Crate in several environments: in laboratory setups; for performing tests during assembly of their detectors; at test beams; and also in-situ at the experiment during commissioning and when running with beam. The ROD-Crate DAQ [1-7] provides this functionality and is part of the TDAQ system itself. It comprises all common software for operating one or more ROD Crates, and it runs inside the ROD Crate (on RCPs) as well as on the RCWs. It provides the functionality for configuration and control, ROD emulation, monitoring, calibration at the level of the ROD Crate, and event building across multiple ROD Crates. The system is described in more detail in Chapter 8.

### 1.3.2 The High Level Trigger system

The HLT system is comprised of the LVL2 trigger and the Event Filter. Although these will both be built using farms of standard PCs interconnected by Ethernet networks, they differ in several important respects. A combination of high rejection power with fast, limited precision algorithms using modest computing power in LVL2, and modest rejection power with slower, high precision algorithms using more extensive computing power in the EF is a cost-effective and flexible way to implement the HLT.

The LVL2 trigger must work at the LVL1 accept rate with an average event treatment time of ~10 ms. In order to operate within this time budget, the LVL2 trigger will use a sequence of highly optimized trigger selection algorithms which operate on only a fraction (typically ~2%) of the event data. The LVL1 trigger identifies regions in the detector where it has found interesting features, so-called Regions Of Interest (ROI) [1-4]. The ROI Builder (ROIB) combines the ROI information from the various parts of the LVL1 trigger and passes it to the LVL2 supervisor (L2SV). The L2SV allocates an event to one of the computing nodes in the LVL2 farm and transfers the ROI information for the event to the allocated processor (see Figure 1-1). These ROIs are then used to seed the LVL2 algorithms. This enables the algorithms to select precisely the region of the detector in which the interesting features reside and therefore the ROBs from which to request the data for analysis. Data requests may be done several times per event by different feature-extraction algorithms that progressively refine the selection. At each stage in the processing an event may be rejected. Each LVL2 processor can treat several events concurrently.

The LVL2 trigger decisions are communicated, via the L2SV, to the DFM for event deletion or building. It should be noted that all the data for a given event are stored in the ROBs during the LVL2 processing and, for selected events, until the event building process is completed.

The Event Filter has to work at the LVL2 accept rate with an average event treatment time of ~1 s. Compared to LVL2, more sophisticated reconstruction and trigger algorithms, tools adapted from those of the offline, and more complete and detailed calibration information are used here in making the selection. The EF receives fully built events from the SFI and so the entirety of the data is available locally for analysis. All the selection processing for a given event is done in a single processor of the EF processor farm. Events not selected by the EF are deleted and those accepted are passed to the SFO for transmission to mass storage.

The scope, complexity, degree of generality, and precision of measured quantities (including  $P_T$ ,  $E_T$ , and isolation variables) of the LVL2 and EF algorithms is different. The overall HLT software selection framework in which they operate has been designed in such a way that all the algorithms may be developed in the same (offline) development environment and have the same data-interface definition. The detailed implementation of this interface is, however, different in each case. This approach has the advantage of having a high degree of development commonality and flexibility of scope across the spectrum of the HLT and the offline, as well as facilitating performance comparisons.

### 1.3.3 The Online software system

The Online Software system is responsible for configuring, controlling, and monitoring the TDAQ system, but excludes any management, processing, or transportation of event data. It is a framework which provides the glue between the various elements of the DAQ, HLT and DCS systems, and defines interfaces to those elements. It also includes information-distribution services and access to configuration and other meta-data databases.

An important part of the Online software is to provide the services that enable the TDAQ and detector systems to start up and shut down. It is also responsible for the synchronization of the entire system, and the supervision of processes. Verification and diagnostics facilities help with the early detection of problems. The configuration services provide the framework for storing the large amount of information required to describe the system topology, including hardware and software components. During data taking, access is provided to monitoring tasks, histograms produced in the TDAQ system, and also the errors and diagnostics messages sent by different applications. One or more user interfaces display the available information and enable the user to configure and control the TDAQ system.

### 1.3.4 The Detector Control system

The DCS supervises all hardware of the experimental set-up, including all detector systems of ATLAS and the common experimental infrastructure. It also communicates with external systems like the infrastructure services of CERN and most notably with the LHC accelerator.

Safety aspects are treated by DCS only at the least-severe level. This concerns mainly questions of sequencing operations or requiring conditions before executing commands. Tools for interlocks, both in hardware and in software, are also provided by DCS. Monitoring and prevention of situations which could cause major damage to the detector or even endanger people's lives are the responsibility of a dedicated Detector Safety System (DSS), and the CERN-wide safety and alarm system, respectively. DCS interacts with both of these systems.

All actions initiated by the operator and all errors, warnings, and alarms concerning the hardware of the detector are handled by DCS. It provides online status information to the level of detail required for global system operation. The interaction of detector experts with their detector is also done via DCS. DCS continuously monitors all operational parameters, gives guidance to the operator, and signals any abnormal behaviour. It must also have the capability to take appropriate action automatically if necessary and to bring the detector to a safe state.

Concerning the operation of the experiment, close interaction with the DAQ system is of prime importance. Good-quality physics data requires detailed synchronization between the DAQ

system and DCS. Both systems are complementary in as far that the DAQ deals with the data describing a physics event (characterized by an event number), while DCS treats all data connected with the hardware of the detector related to the operational state of the detector when the data were taken (categorized by a time interval). The correlation between them is required for offline analysis.

Some parts of the detector will operate continuously because any interruption is costly in time or money, or may even be detrimental to the performance of that detector. Hence supervision by DCS is needed continuously. DAQ in contrast is required only when physics data are taken or during specific monitoring, calibration, or testing runs. Therefore DCS needs complete operational independence. This must, however, not result in boundaries which limit functionality or performance. Therefore both DAQ and DCS share elements of a common software infrastructure.

## 1.4 Data types

The TDAQ system has to deal with several broad classes of data which possess different characteristics. These classes are introduced here briefly and discussed in more detail later in the document.

- Detector control data

The DCS system will produce large amounts of system status and hardware-parameter data at frequencies of up to of order 1 Hz. However, if the system being monitored is in a stable condition, it can be expected that these values will change little over periods of several hours or more. The important quantity to monitor in many cases will therefore be variations of the values read rather than the values themselves, thus reducing the need to transport and store large quantities of very similar data across the DCS and online control networks. A more detailed discussion of DCS data handling can be found in Chapter 11.

- Event data

Event data are those read out from the detectors following a trigger, with the addition of the data produced by the various stages of the trigger itself while processing the event. The detailed internal format of these data is defined by the characteristics of each detector's readout electronics. However, the data are surrounded by headers and trailers in a 'raw data event' format that is common across the experiment [1-8]. Event data are represented physically as a single stream of bytes, which is subsequently referred to as a 'bytestream'. Prior to their use in the HLT, bytestream data are reformatted and converted into quantities more suitable for the selection algorithms (see Chapter 9). Bytestream data from events accepted by the HLT will be stored in mass storage in preparation for the prompt reconstruction — the first step in the offline analysis. Event data are transported by the Data Flow central network.

- Configuration data

These data are used to configure the TDAQ and detector systems in preparation for data-taking and they define the precise configuration of the system used for a particular run. Examples of this data type include electronics parameters and thresholds, module mapping, software executables, network parameters, trigger parameters and thresholds, high-voltage values, etc. A given data-taking run is defined by a unique set of configuration data. The run's configuration data are stored in and accessed from a dedicated in-memory

database during data taking. Configuration data are transported over the Online control network.

- Conditions data

Conditions data include all data that are relevant for the complete analysis of any given selection of event data and include data from some of the above categories. Conditions data will be stored for the lifetime of the experiment and are labelled by Interval-of-Validity (IOV) tags. The conditions data for a given run will include all the configuration data used for that run, the associated DCS data, detailed detector calibration data, magnet calibration, etc. Conditions data will be produced and accessed in many different areas of the experiment, both online and offline. Conditions data in the TDAQ system are transported over the DCS and Online control networks.

- Online statistics and monitoring data

This type of data will be produced in large quantities by both the detectors and the TDAQ system during data taking. They are similar in some respects to DCS data in that in many cases, the monitoring and observation of the variation of parameters is more important than the parameter values themselves. This data type will be transported by both the central Data Flow network (in the case of data being sampled from the main event data flow for monitoring purposes e.g. to produce detector wire-maps etc.) and the Online control network. This subject is addressed in detail in Chapter 7.

## 1.5 Long-term issues and perspectives

A more detailed view of TDAQ planning for the immediate future is described in Chapter 18, but it is useful to set out the principal elements of the overall ATLAS planning here. In the current ATLAS installation schedule [1-5], the initial detector will be completed in December 2006, ready for the first LHC collisions in April 2007. A cosmic ray run is planned in Autumn 2006, in its first year of operation, the target is for the LHC to attain a luminosity of  $2 \times 10^{33} \text{ cm}^{-2} \text{ s}^{-1}$ . The installation schedule of the TDAQ system is dictated both by constraints coming from the installation of the system itself, as well as by the detector installation and commissioning schedule. In particular, the needs of the detectors for TDAQ services during that time should be fulfilled.

The first elements of the TDAQ system will be required by the detectors in early 2005, and the ROD crate DAQ system (Section 1.3.1.1) in late 2004. The required TDAQ elements are those directly involved in the initial detector readout, such as the ROBs, as well as some specific associated software elements and the complete DCS system. These components are well advanced, with in many cases that prototypes or production modules being available now or at the latest by the end of 2003. The use of these elements in the ATLAS test beam has already been noted as one important element in their development. Elements of the system further down the chain, in particular the HLT farms, their interconnections, and software will be required later. The description of these elements in this TDR documents the current status of development of the system. It is clearly desirable to purchase computing and network hardware as late as possible, while being consistent with the ATLAS schedule, to benefit from the latest technological developments. It is vital that maximum flexibility be kept in both the system schedule and design in order to facilitate this.

The increasing size and timescale of high-energy physics experiments means that their associated software is becoming increasingly complex. The software will have to be maintained and

supported over periods of fifteen years or more by people who will come and go from the experiment on a much shorter timescale. In order to ease the long-term maintenance issues, a big emphasis in the TDAQ system is being given to the use of a well-defined and appropriate software-development process (see Chapter 15), to coherent error handling and fault tolerance (see Chapter 6), and to documentation.

The use of test beams to validate and test designs and prototype implementations of elements of the system has already been mentioned. However, this offers testing on a very small scale compared to that of the final experiment (test-beam implementations typically have just a few VME-bus crates and their associated support services). Therefore, it is desirable to test the system also on testbeds which are as large as possible within budget constraints. Furthermore, experience shows that many performance and functionality issues will only appear when testing on larger prototypes and testbeds. Nevertheless these testbeds may only represent some 10-20% of the final system size and so the extrapolation of measurements from them to the full system via advanced modelling techniques is also a vital element in the overall system-design validation. Testbed and modelling results for the system are presented and discussed in Chapter 14.

As mentioned at the beginning of this chapter, several design and technical documents precede this TDR. Further design documents will be produced by ATLAS before the start of data taking, notably the offline computing TDR which is expected in some two years from now. The offline computing TDR document will present a continuation and more complete analysis of some aspects addressed already in this TDR. In particular it will further address the areas of the trigger selection software and performance, the definition of and access to conditions (calibration) data online, and the architecture of the mass storage and prompt reconstruction system, which immediately follow the output of the EF.

## 1.6 Glossary

A complete glossary can be found in Appendix B. This section addresses a few general nomenclature issues to assist the reader. For the purposes of this document, the following principal definitions are assumed:

- Detector — one of the several principal detectors of ATLAS such as the muon detector, the calorimeter detector, and tracking detector.
- The ATLAS Detector — the integrated complete set of detectors used to form the ATLAS experiment.
- Sub-detector — component parts of detectors such as a liquid argon calorimeter or the muon RPCs.
- System — the component systems of the TDAQ are the LV11 trigger together with those defined in Section 1.3.
- Subsystem — the component parts of any of the above TDAQ systems, e.g. the LV12 trigger, the LV11 muon trigger.
- TDAQ — comprises the LV11 trigger, HLT and DAQ (including DCS).
- HLT/DAQ — the TDAQ excluding the LV11 trigger.



## 1.7 References

- 1-1 ATLAS Trigger Performance Status Report, CERN/LHCC/98-15 (1998)
- 1-2 ATLAS DAQ, EF, LVL2 and DCS Technical Progress Report, CERN/LHCC/98-16 (1998)
- 1-3 ATLAS High-Level Triggers, DAQ and DCS Technical Proposal, CERN/LHCC/2000-17 (2000)
- 1-4 ATLAS First-Level Trigger Technical Design Report, CERN/LHCC/98-14 (1998)
- 1-5 ATLAS Installation webpage,  
<http://cern.ch/Atlas/TCOORD/Activities/TeOffice/Scheduling/Installation/ATLASInstallation.html>
- 1-6 Trigger & DAQ interfaces with front-end systems: requirement document version 2.0, ATLAS EDMS Note, ATL-D-ES-0013,  
<https://edms.cern.ch/document/384600/2>
- 1-7 ROD Crate DAQ Task Force, Data Acquisition for the ATLAS ReadOut Driver Crate (ROD Crate DAQ), ATLAS EDMS Note, ATL-D-ES-0007,  
<https://edms.cern.ch/document/344713/1>
- 1-8 The raw event format in the ATLAS Trigger & DAQ, ATLAS Internal Note, ATLAS-DAQ-98-129 (1998)

## 2 Parameters

This chapter presents the parameters relevant to the HLT/DAQ/DCS system. These include the detector readout parameters and the trigger selection for the correct dimensioning of the data-flow system and for understanding the data volumes that will need to be stored. These are the subject of the first two sections.

Other important parameters for the correct definition of the system are those coming from the monitoring and calibration requirements. These are discussed in the following two sections.

The last section is dedicated to the DCS parameters: the subdivision of the system in detector parts and the amount of configuration data traffic in the case of startup configuration and re-configuration of possible faulty elements.

### 2.1 Detector readout parameters

The ATLAS detector consists of three main detection systems: the Inner Detector, the Calorimeter System and the Muon Spectrometer. These systems are subdivided into sub-detectors.

The Inner Detector is divided into three sub-detectors: Pixels, SCT and TRT [2-1], [2-2]. The Pixels sub-detector consists of semiconductor detectors with pixel readout. It is divided into two endcaps, an innermost barrel 'B-layer' and two outer barrel layers. All parts mentioned are divided into  $\phi$  regions. The SCT sub-detector is built from silicon microstrip detectors. It is subdivided into two endcaps and a barrel part. The latter is subdivided into two regions, one for positive and the other for negative  $\eta$ . The TRT sub-detector is a tracking detector built from straw tube and radiator, and features identification of highly relativistic particles by means of the transition radiation generated.

The Calorimeter System consists of several sub-detectors based on different technologies. The barrel electromagnetic, the endcap electromagnetic, the endcap hadron and the forward calorimeters use liquid argon as the active medium [2-3]. The barrel and two extended barrel hadron calorimeters at larger radii (with respect to the other calorimeters) in the range  $|\eta| < 1.7$ , together forming the Tilecal calorimeter, are based on scintillator-iron technology [2-4].

The Muon Spectrometer is divided into a barrel part and two endcaps extending up to  $|\eta| \leq 2.4$ . The barrel consists of precision chambers based on Monitored Drift Tubes (MDTs), and trigger chambers based on Resistive Plate Chambers (RPCs). The two endcaps contain both MDTs and another type of trigger chamber: Thin Gap Chambers (TGCs). Furthermore at large pseudorapidities and close to the interaction point, Cathode Strip Chambers (CSCs) are used, which can handle the higher rate and the severe background conditions [2-5].

The LVL1 Trigger is another source of data for the Data Acquisition (DAQ) system, and dedicated ReadOut Drivers (RODs) are used [2-6].

The organization of the ATLAS detector readout is specified in Table 2-1 in terms of the partitioning, of data sources (the RODs), of ReadOut Links (ROLs), and of ReadOut System (ROS) subsystems, assuming that a maximum of 12 ROLs can be connected to a single ROS subsystem. The information in the table is for a large part based on information provided by the subdetector groups during the third ROD Workshop held in Amnecy in November 2002 [2-7]. The parti-

tions used coincide with the TTC partitions described in [2-6]. Each ROD module, each ROD crate and each ROS subsystem is associated with a single partition. Each partition can function independently.

In the following the official ATLAS coordinate system will be used, therefore the definitions of this system are briefly summarized [2-8].

A and C are the labels used to identify the two sides of any ATLAS component with respect to the pseudorapidity  $\eta = 0$ . They correspond to the convention of the two sides of the ATLAS cavern. If we define the Z axis as the one along the beam direction, when looking from inside the LHC ring, the positive Z axis is the left direction. The positive Z is identified as side A. The negative Z is the right direction and is identified as side C. The beam is going from right to left along Z. The side B is kept for elements on the  $Z = 0$  plane.

The X-axis is horizontal and points from the IP to the LHC ring centre. The Y axis is perpendicular to X and to Z, and is inclined by 1.236% with respect to the local perpendicular of the cavern floor. This small angle is needed to follow the beam slope.

The  $\phi$  angle is measured from the polar X axis with positive values in the anti-clockwise direction. The pseudorapidity  $\eta$  is measured from the Y axis, positive towards Z-positive (side A).

Table 2-1 The distribution of the RODs per detector per partition.

Detector	Partition	RODs	ROD crates	ROLs	ROS subsystems	ROLs per ROS subsystem
Inner Detector	B Layer	44	3	44	4	3 * 12 + 8
	Disks	12	1	12	1	1 * 12
	Layer 1 + 2	38 + 26	4	38 + 26	6	5 * 12 + 4
SCT	Barrel A	22	2	22	2	1 * 12 + 10
	Barrel C	22	2	22	2	1 * 12 + 10
	Endcap A	24	2	24	2	2 * 12
TRT	Endcap C	24	2	24	2	2 * 12
	Barrel A	32	3	32	3	2 * 12 + 8
	Barrel C	32	3	32	3	2 * 12 + 8
LAr	Endcap A	84	7	84	7	7 * 12
	Endcap C	84	7	84	7	7 * 12
	EMB A	56	4	224	19	18 * 12 + 8
	EMB C	56	4	224	19	18 * 12 + 8
	EMEC A	35	3	140	12	11 * 12 + 8
HEC	EMEC C	35	3	140	12	11 * 12 + 8
	FCAL	4	1	16	2	1 * 12 + 4
	HEC	6	1	24	2	2 * 12

**Table 2-1** The distribution of the RODs per detector per partition.

Tilecal	Barrel A	8	1	16	2	1 * 8 + 4
	Barrel C	8	1	16	2	1 * 8 + 4
	Ext Barrel A	8	1	16	2	1 * 8 + 4
MDT	Ext Barrel C	8	1	16	2	1 * 8 + 4
	Barrel A	48	4	48	4	4 * 12
	Barrel C	48	4	48	4	4 * 12
CSC	Endcap A	48	4	48	4	4 * 12
	Endcap C	48	4	48	4	4 * 12
	Endcap A	8 + 8	1	16	2	1 * 8 + 4
RPC	Endcap C	8 + 8	1	16	2	1 * 8 + 4
	Barrel A	16	1	16	2	1 * 8 + 4
	Barrel C	16	1	16	2	1 * 8 + 4
TGC	Endcap A	8	1	8	1	1 * 8 + 4
	Endcap C	8	1	8	1	1 * 8 + 4
	Endcap A	1	1	1	1	4 * 12 + 8
LVL1 (Rol, CP, JEP and PP RODs belong to the same partition)	MIROD	1	1	1	5	4 * 12 + 8
	Rol	6	1 or 2	6		
	CP	4		16		
CTP	JEP	4		16		
	PP	4	8	16		
	CTP	1	1	1		
Total	33	984	92	1628	146	

Each subdetector will contribute to the ATLAS event with a data fragment. The maximum expected data fragment sizes, as specified by the subdetector groups, and estimates of the data fragment sizes are presented in Table 2-2. To each data fragment is added a ROD header and trailer (48 Bytes total) and a ROB Input (ROBin) header (56 Bytes). In general, a ROS subsystem will concatenate several data fragments and then add a ROS header (52 Bytes) and a wrapper for the Data Collection software (36 Bytes), the latter is removed on receipt of the data. The total event size without and with headers is also specified in the table and falls in the range 1.2–2.2 Mbyte.

It is worth mentioning that there will be a staging of some detector components since it is necessary to have a detector that is ready for the first LHC collisions in Spring 2007 and because of the deferral of some part of the funding for the completion of the detector instrumentation. This staging scenario has an impact on the number of RODs for some detectors: the Pixel sub-detector will stage the Layer 1 [2-2], the TRT sub-detector will stage the two end-cap C-wheels [2-1], the CSC sub-detector will stage 8 chambers per endcap [2-5], and the LAr sub-detector will stage the instrumentation of the RODs by using half of the DSP boards and re-arranging the

**Table 2-2** Estimates and maximum data fragment sizes in bytes.

Subdetector	Number of RODs	Low luminosity ( $2 \times 10^{33} \text{ cm}^{-2} \text{ s}^{-1}$ )	Design luminosity ( $1 \times 10^{34} \text{ cm}^{-2} \text{ s}^{-1}$ )	Max. as specified in ROD workshop of November 2002
Pixels	120	200	500	1300
SCT	92	300	1100	1600
TRT	256	300	1200	1200
E.m. calorimeter (LAr Barrel and EMEC)	728	752	752	1400
Hadron calorimeter	64 (Tilecal)	752	752	1100 (Tilecal)
Muon precision	24 (HEC)	752	752	1400 (LAr)
Muon trigger (RPCs and TGCs)	192	800	800	1000
CSC	48	380	380	1000
FCAL	32	200	200	200
LVL1	16	1400	1400	1400
Total event size, raw		1 006 864	1 346 864	2 064 000
Total event size, with headers		1 183 352	1 523 352	2 240 488

ROD output to reduce by a factor two the number of RODs [2-3]. This initial staging scenario is summarized in Table 2-3.

## 2.2 Trigger and DataFlow parameters

Two baseline scenarios are used in this report:

1. 'low luminosity': for a luminosity of  $2 \times 10^{33} \text{ cm}^{-2} \text{ s}^{-1}$  with a LVL1 accept rate of about 20 KHz. The LVL2 accept rate is expected to be about 600 Hz.
2. 'design luminosity': for a luminosity of  $1 \times 10^{34} \text{ cm}^{-2} \text{ s}^{-1}$  with a LVL1 accept rate of about 35 KHz. The LVL2 accept rate is expected to be about 1.5 KHz.

The 'LVL1 trigger menus' associated with these scenarios are specified in Chapter 4 and in Appendix A. In view of the uncertainties in the trigger rates, the TDAQ system is required to cope with the rates implied by a LVL1 rate of 75 KHz. For low luminosity the LVL2 accept rate is in that case 2.2 KHz, while for high luminosity it is 3.3 KHz.

The data needed for the LVL2 trigger and the type of processing performed by it, depend on the regions of interest supplied by the first level trigger. Each of the four different types of Rols (muon, electron/gamma, jet, and hadron) has its own characteristic type of processing. The processing consists of several steps and after each step a decision is taken on whether data

**Table 2-3** Number of RODs and ROLs for the initial ATLAS detector.

Subdetector	Initial detector		Final detector	
	Number of RODs	Number of ROLs	Number of RODs	Number of ROLs
Pixel (no Layer 1)	82	82	120	120
SCT	92	92	92	92
TRT	192	192	232	232
LAr	192	384	192	768
Tilecal	32	64	32	64
MDT	192	192	192	192
CSC	16	16	32	32
RPC	32	32	32	32
TGC	16	16	16	16
LVL1	24	56	24	56

from other sub-detectors within the region of interest should be requested for further analysis. The data rates can be estimated with the help of information on the type, rate, sizes, locations of the regions of interest, and on the mapping of the detector onto the ROB inputs (ROBins). More details are provided in Appendix A. Table 2-4 presents an overview of typical values of rates and data volumes for a 75 kHz LVL1 trigger rate.

**Table 2-4** Typical values and rates for a 75 kHz LVL1 trigger rate.

	Low luminosity	Design luminosity
Average number of ROLs per Rol request, per LVL1 trigger	17.9	16.2
Average number of groups of 12 ROLs receiving a Rol request, per LVL1 trigger	9.0	8.5
Maximum average output bandwidth per ROBin (Mbyte/s)	6.7	6.9
Maximum average Rol request rate per ROBin (kHz)	5.6	4.8
Maximum average output bandwidth per 12 ROBins (Mbyte/s)	53	59
Maximum average Rol request rate per 12 ROBins (kHz)	16	14
Total bandwidth LVL2 traffic (Gbyte/s)	1.2	1.1
Event Building rate (kHz)	2.2	3.3
Total bandwidth traffic to Event Builder (Chyte/s)	2.7	5.0

The size of the LVL2 farms and the number of Sub-Farm Inputs (SFIs) has been estimated assuming the use of dual CPU, respectively single CPU computer server (4 GHz PCs). Details of the acceptance factors for the various steps of the LVL2 processing and of processing times are provided in Appendix A. It is expected that at a 75 kHz LVL1 rate about 100–150 dual CPU machines will be needed for the LVL2 farm, and about 50–100 SFIs, assuming an input bandwidth per SFI of  $\sim 70$  Mbyte/s. The SFIs send the complete events for further analysis to the Event Filter where a factor of ten rate reduction is expected (see Chapter 13). For a typical processing time of one second per event a farm of at least 1000 dual-processor machines will be needed.

## 2.3 Monitoring requirements

Monitoring will require the transfer of event fragments and/or monitoring results such as histograms from the sources to the destinations. The following sources of data can be identified:

- ROD
- ROS
- SFI
- Trigger processors (LVL1, LVL2, EF).

Investigations are under way to identify the destinations and the traffic generated. Possible destinations are:

- private workstations in the main Control Room (SCX1)
- Online monitoring farm (possibly a sub-set of the EF Farm), the location of which is not yet defined. It should be noted that results from the Online Monitoring farm will then be sent to the main Control Room.

More details on monitoring during data taking can be found in Chapter 7 and in [2-6].

Table 2-5 summarizes the present knowledge of the relations between the sources and the destinations for monitoring. Detailed results of the survey sent to detector and physics groups can be found in [2-7]. Some figures for the expected traffic generated by monitoring are still missing, but the ones quoted here should be considered as a reasonable upper limit. Event fragments coming from ROD are very likely to be moved on the Data Collection network. The situation of event fragments coming from the ROS needs to be clarified, while other pieces of information should travel on the Control network (i.e. standard TCP/IP on Fast or Gigabit Ethernet).

## 2.4 Calibration requirements

The sub-detector calibrations are another important source of data for the experiment. Depending on each sub-detector and on each type of calibration, the data may flow from the front-end electronics, through the RODs, to the ROD Crate Controller or to the same data flow elements used during the normal data taking, i.e. to the ROS and up to the Sub-Farm Output.

This section presents a very condensed view of the calibrations of the electronics or of the reference systems for the sub-detectors (e.g. the Tilecal LASER system). The in situ calibration of the detector with dedicated physics channels are instead treated in Chapter 4.

Table 2-5 Monitoring matrix

Destination	Source	ROD/ROB	ROS	SFI	Trigger processors
Private WS in Control Room		<ul style="list-style-type: none"> <li>event fragments (~5 Mbyte/s?)</li> <li>histograms, scalers, files, numbers from operational monitoring (several Gbyte once every hour)</li> </ul>	<ul style="list-style-type: none"> <li>event fragments (some hundreds of Mbyte/s)</li> <li>histograms (few Mbyte/s, surges of ~6 Gbyte every hour)</li> </ul>	<ul style="list-style-type: none"> <li>histograms (some tens of Mbyte/s)</li> </ul>	<ul style="list-style-type: none"> <li>histograms (some Mbyte/s)</li> </ul>
Online Farm		<ul style="list-style-type: none"> <li>calibration data (Muons, size not yet fully decided)</li> </ul>	<ul style="list-style-type: none"> <li>if not done at SFI level (same load)</li> </ul>	<ul style="list-style-type: none"> <li>events</li> <li>calibration data (several tens of Mbyte once a day)</li> </ul>	<ul style="list-style-type: none"> <li>rejected events (<math>\leq 1\%</math> of the total bandwidth)</li> </ul>

The aim of this section is not to describe in detail each sub-detector calibration, but rather to indicate when the data will flow through the Data Acquisition infrastructure, how frequently, and the amount of data produced. Only a partial view can be given owing to the current status of the calibration strategy elaborated by each sub-detector.

Most of the calibrations are dedicated to the characterization of the sub-detector modules via comparator threshold scans (e.g. SCT, Pixel, and TRT), or of the read-out electronics with injection of reference charges to check the amplitude and the timing of the output signals (e.g. SCT, Pixel, TRT, LAr and Tilecal).

In other situations real physics data are needed for example for the timing adjustment of the on-chamber electronics (Muon MDTs).

Most of the calibrations require dedicated runs, but there are calibrations that are performed while taking data in physics mode, during the assigned LHC empty bunches (e.g. the Tilecal LASER system). Some other calibrations do not interact with DAQ and will make use of dedicated data-acquisition systems: the Tilecal Cs source system, the SCT and the MDT alignment systems.

The use of the DAQ Dataflow Infrastructure (high bandwidth and substantial computing power) for some of the calibrations has not yet been decided. However given the amount of data produced and the computing power required for calculation, it seems to be the only possible choice. This is for example the case of the LAr 'technical calibrations' in which all the samples are sent out from the RODs, producing about 50 Gbyte of data to be treated. In this case, a clear solution comes from sending the data to a dedicated Event Filter processing task [2-7]. Table 2-6 summarizes the current view on the sub-detector calibrations, elaborated initially from the various talks held during the DTC Forums [2-9].

## 2.5 DCS parameters

DCS deals with two categories of parameters: input parameters, which are used to set up both the DCS itself and the detector hardware, and output parameters, which are the values of the measurements and the status of the hardware of the experiment. For the first class, the ATLAS

Table 2-6 Summary table of some of the sub-detector calibrations.

Detector	Calibration	May require DataFlow	Dedicated run	During Physics	Comments
SCT	Module characteristic	No	Yes	No	Typical
	Module characteristic	Yes	Yes	No	Sophisticated
	ROD settings	No	No	Yes	Monitoring
	Detector alignment	No	Yes	No	Separate DAQ
	Detector alignment	Yes	No	Yes	Real data
TRT	Setup calibration timing	Yes	Yes	No	
	Setup calibration noise	No	Yes	No	
	X-check calibration TP time delay	Yes	Yes	No	
	X-check calibration TP amplitude	No	Yes	No	
Pixel	Module characteristics	No	Yes	No	
	Timing	Yes	No	Yes	Real data
LAr	Standard calibration	No	Yes	?	Calculations in RCC: 50 Mbyte
	Technical calibration	Yes	Yes	?	50 Gbyte
Tilecal	Cs source	No	Yes	No	Dedicated DAQ
	LASER	Yes	Yes	Yes	Dedicated runs + during empty bunches
	Charge injection	Yes	Yes	Yes	Dedicated runs + during empty bunches

wide configuration database (Conddb) will be used and the second class will be stored in the ATLAS conditions database (Conddb).

Two different types of set-up parameters are needed by DCS: static data defining hardware and software of the DCS set-up, and variable data describing the operation of the detector. The DCS read-out chain, which is described in detail in Chapter 11, comprises the supervisory PCs of the Back-End and Front-End devices with their individual channels. This set-up will change only very infrequently, i.e. only at times of hardware re-configuration like replacement of broken equipment or addition of new devices. The associated data volume is large because of the very many separate systems and the very high number of channels to be configured: of the order of 250 000. However, a high data transfer rate is not required as the operations are not time-critical and will normally be performed during shutdown periods.

The variable data are used to configure the sub-detectors for the operation. Depending on the beam conditions of the LHC, different sets of operational parameters are needed for some parts of the detector. Also the different types of DAQ runs require different operational parameters.

All these sets of dynamic configuration data are loaded at boot-up time into the relevant DCS station. This operation is therefore also not time-critical. During running of ATLAS, updates of subsets may be needed, hence access to the ConFDB is required at all times and it is important to guarantee the consistency of the data between the database and the running sub-detector systems.

The output data of DCS are the measurements of the operational parameters of the detector and the infrastructure of the experiment, and also the conditions and status of systems external to ATLAS (see Section 11.9), most notably the LHC accelerator. Some of these data are directly used in the offline physics analysis, e.g. as calibration for detector elements, and hence need to be stored in the ConFDB. Also the remainder of the DCS data, which at first glance has no direct influence on the physics analyses, has to be stored in the ConFDB. It may be necessary to correlate it with the event data in order to understand the behaviour of the detector. Much of this data is structured in very small entities; it essentially consists of the triplet definition, time, and value. The update frequency can be tuned individually and many quantities need only be stored when they change by more than a fixed threshold. Nevertheless the total data volume is high and may reach 1 Gbyte per day. This data can be sent to the ConFDB asynchronously, i.e. it can be held for small periods of time within DCS.

## 2.6 References

- 2-1 ATLAS Inner Detector Technical Design Report, CERN/LHCC 97-16 (1997)
- 2-2 ATLAS Pixel Detector Technical Design Report, CERN/LHCC 98-13 (1998)
- 2-3 ATLAS Liquid Argon Calorimeter Technical Design Report, CERN/LHCC 96-41 (1996)
- 2-4 ATLAS The Calorimeter Technical Design Report, CERN/LHCC 96-42 (1996)
- 2-5 ATLAS Muon Spectrometer Technical Design Report, CERN/LHCC 97-22 (1997)
- 2-6 ATLAS First Level Trigger Technical Design Report, CERN/LHCC 98-14 (1998)
- 2-7 3rd ATLAS ROD Workshop, <http://www.wlapp.in2p3.fr/RODD2002/>, <http://agenda.cern.ch/fullAgenda.php?ida=a021794> (2002)
- 2-8 ATLAS Technical Co-ordination Technical Design Report, CERN/LHCC 99-01 (1999)
- 2-9 ATLAS Technical Co-ordination, Detector Interface Group, DIC Forums, <http://atlas.web.cern.ch/Atlas/GROUPS/DAQTRIG/DIG>

## 3 System Operations

### 3.1 Introduction

This chapter describes how the TDAQ system will be used. While the main use of the ATLAS TDAQ system naturally refers to the periods of data taking, there are also operational aspects related to those periods of time when the LHC machine is off.

The chapter starts with a definition of what conditions have to be met in order for TDAQ to perform certain operations: for instance what conditions have to be met in order to take data from the detector. The definitions are given in terms of relationships between system states.

A large part of the chapter is dedicated to defining the data taking period, the run. In particular it discusses the different types of run, what operations are defined during a run and the transitions between one run and another.

The requirement for the TDAQ system to support multiple concurrent runs on different parts of the detector, partitions, is discussed next.

### 3.2 TDAQ states

In the context of the ATLAS experiment, operations involve three main actors: the ATLAS detector (the detector for short in the following), the LHC machine and the TDAQ system. The high-level operation of the experiment, and the relationships between the main actors defined above, are described in terms of states. A state is a concept which summarises what a part of the experiment is capable of doing at a certain point in time. States are also useful to describe how actors relate one to another. The further development of the concept of states, their refinement in terms of sub-states and their detailed relationships, is the subject of Chapter 12.

Three main states are useful to describe the way TDAQ can operate:

- **Initial:** in this state the TDAQ system is not capable of performing any useful operation for the experiment (apart from being able to communicate with the sub-systems for the purpose of initialization and configuration). The only operations allowed on TDAQ are those which bring it to a situation where data taking can be performed (see below). This may be the state into which TDAQ is for example after a power failure, or TDAQ may revert to this state in order to re-initialise large parts of ATLAS.
- **Configured:** in this state the TDAQ system is ready, provided other conditions are met (for example related to the detector or the LHC machine), to initiate a data taking session. This means that the various parts and components have been properly initialised and set. For the purpose of detailing the initialisation procedures, the configured state may be reached by means of intermediate states, related for instance to loading software into processors, configuring components, etc.
- **Running:** in this state the TDAQ system is taking data from the detector.

For the purpose of the global operation of the experiment, two states are associated to the detector:

- **Ready:** the detector can be used for data taking.
- **Not Ready (or  $\overline{\text{Ready}}$ ):** the detector cannot be used for data taking.

Three states may also summarise, for the purpose of operating TDAQ, the conditions of the LHC machine:

- **Stable-Beams:** the LHC machine is in a condition which allows safe operation of the detector and beams are available to produce physics events.
- **Detector-Safe:** the LHC machine is in a condition which allows safe operation of the detector and beams are not available.
- **Non Stable-Beams (Stable-Beams $\bar{}$ ):** the LHC machine is not in a condition which allows operation of the ATLAS detector.

The diagrams of Figure 3-1 indicate the inter-relationships of the detector, machine and TDAQ states both for stable and non-stable beam conditions.

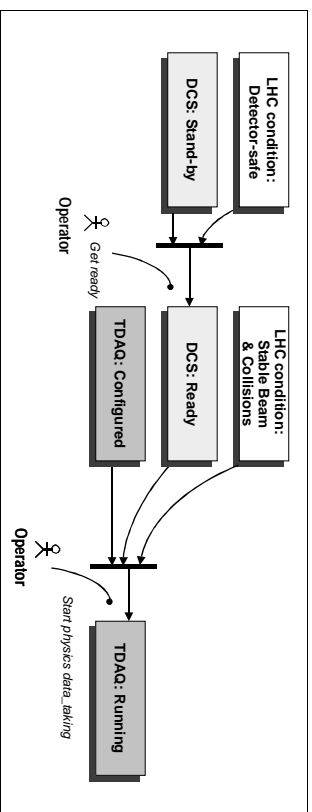

Figure 3-1 Inter-relationship of the detector, machine and TDAQ states for stable and non-stable beam conditions

### 3.3 The run

#### 3.3.1 Run definition

A run is defined as a period of data taking in a TDAQ partition with a defined set of stable conditions (as defined in Chapter 1) related to quality of physics.

Whilst it is difficult to give today an exhaustive list of changes in running conditions that will force the starting of a new run, a number of items come immediately to mind: the parameters defining or affecting the selectivity of the triggers (LV1, LV1.2 and EF); the set of sub-detectors participating to the TDAQ partition, the operational parameters of sub-detectors. A modification of any of the above conditions forces a new run, that is the events following the change of the conditions are tagged with a new run number.

Conditions whose change force a new run are stored in a conditions database, whose contents are saved to permanent storage prior to the start of a new run.

Changes which do not force a new run include, for example, the removal or the insertion of processors or the disabling of FE channels (insofar as the physics is not affected). Those changes which do not force a new run number may not be stored in the conditions database. The change may be entered for example in an electronic experiment logbook if it affects the performance of the TDAQ system (e.g. removal of an EF processor) or tagged into the event if it affects the data from the detector. As an example of the latter: the removal of a detector or DAQ buffer may be flagged by appropriately setting a 'quality flag' in the fragment header.

A run, when conditions do not change, may extend throughout an entire machine fill.

### 3.3.2 Run Identification

The run number uniquely identifies a run (today it is a 32-bit number); it associates an event to a set of stable conditions. A run number is unique and is never re-used during the lifetime of the experiment. A run number is generated by a central service.

The proposed mechanism to tag events with the run number is based on the distribution of the run number (at the beginning of a run) to the ROD crate controllers. The RODs will then insert the run number into the fragment header for each event.

Any event fragment is partly identified, anywhere in the system, by its associated run number.

### 3.3.3 Event Identification

Up to acceptance by LVL2 (or event building in the case of a partition without LVL2) an event is identified by an extended (32-bit) LVL1 ID (L1ID, generated by LVL1 as a 24-bit number and extended to 32 bits).

A Global Event Number (GID) uniquely identifies an event, accepted by the LVL2 trigger, within a run. It is generated by a central element (the DFM) after the LVL2 decision and it is made available, to be inserted into the event, to the element responsible for building the full event (the SFI).

Therefore an event, during the lifetime of ATLAS, is uniquely identified by the pair of 32-bit numbers consisting of the run number and the Global Event Number.

### 3.3.4 Performance requirement

The ATLAS TDAQ system is required to minimise its contribution to the experiment down time; although a quantitative definition of this requirement is not yet available, one can anticipate that the experiment down time due to TDAQ must be well below 1%.

There are two contributions to system down-time which are relevant to the subject of this chapter:

1. For example the number of FE channels (or ROBs) which can be removed from the read-out without affecting the physics is bounded by some threshold which is sub-detector dependent. When the amount of unavailable read-out exceeds the threshold, the physics is affected and the run should be stopped.

- the time spent by the system to initiate (start) or terminate (stop) a run, and
- the down time when coping with malfunctioning TDAQ components.

The two contributions above have an important impact on:

- how a run is defined, that is which configuration and parameter changes force a new run and which changes do not force a new run,
- how the transition between runs should be implemented, and
- how faults should be handled during a run.

### 3.3.5 Categories of runs

A data taking session on the ATLAS detector may be started for different purposes. A broad categorization of different types of runs follows.

**Physics run:** to record event data from the detector for the purpose of physics analysis. The participating actors in this kind of run are: all or part of the ATLAS detector, a fully functional (i.e. including the high level triggers) TDAQ, the DCS, the LHC machine, and the LVL1 trigger (including the Central Trigger Processor).

**Detector calibration with beams:** to calibrate (part of) an ATLAS sub-detector using data produced by the LHC beam in the sub-detector. The participating actors are a sub-set of those related to the physics run above: a sub-set of the ATLAS detector (a sub-detector partition, a complete sub-detector or some combination of sub-detectors), the LHC machine in 'stable beam' state, the first level trigger (see below) but not the high level triggers. However one can anticipate that the event filter infrastructure (e.g. a sub-set of the event filter farm) will be used for the purpose of running calibration software at the level of the complete event. As regards the first level trigger, the proper sub-set of the TTC system and the Local Trigger Processor for the sub-detector in question will be part of the data taking sub-system (a TDAQ partition as defined in Section 3.4).

**Detector calibration without beams:** this type of run needs the same actors as for detector calibration with beams above. There are two main differences, however: the LHC machine has to be in a 'detector safe' state, i.e. such that the detector may be safely switched on, and (depending on the detector being calibrated) the complete TDAQ functionality, or only the DCS functionality may be needed.

**(Sub-)Detector commissioning:** a type of run intended to put a sub-detector (and eventually the whole ATLAS detector) into an operational state. This may include also the initial run with cosmic rays. This type of run is similar to a calibration run with the exception that a 'stable beam' state for the LHC machine is emulated, in the case the LHC machine is not yet available. The high level triggers, as well as the Central Trigger Processor, may be part of a commissioning-like run, e.g. during the commissioning stage of the experiment.

The categories of runs above refer to the way the TDAQ system is globally set up for data taking. **Calibration during a physics run** is also required. This refers to a TDAQ system, set for a 'physics run', which also deals with special triggers, such as calibration triggers fired by a sub-detector during empty LHC bunches. These special triggers are marked as such, i.e. identified



by a proper trigger type, and are dealt accordingly by the TDAQ system; for example a calibration trigger is always accepted by LVL2 and may be routed, by the Event Builder, to a specific Event Filter sub-farm for the purpose of being treated by dedicated software.

### 3.3.6 Operations during a Run

A TDAQ run is bracketed by two commands: one to start it and one to stop it (in the following referred to as 'Start' and 'Stop').

**Start:** the TDAQ system is in the 'configured' state (Section 3.2), the command is distributed to all the TDAQ elements. Any TDAQ element performs its own 'run start' sequence and then completes the transition to the 'running' state. When all the TDAQ elements have completed their transition to the 'running' state, the TDAQ system as a whole enters the 'running' state. At this point the first level trigger is enabled and events may start to flow in the system.

**Stop:** first the LVL1 triggers are disabled, then the command is distributed to all the TDAQ elements, each of them completes its task in an orderly way, in particular each element completes the processing of all the events in its queues and optionally produces an 'end of run' summary. Upon completion of its task, the TDAQ element re-enters the 'configured' state. When all the TDAQ elements have completed their transition to the stopped state, the TDAQ system as a whole enters the stopped state.

A need is foreseen for a 'Pause' command to interrupt data taking in order to perform some operation on the detector that will not force a new run. This could involve changes before LVL1 triggers are generated. The global system state associated to the temporary interruption of a run is called 'Paused'.

Two commands are available to respectively enter and exit the Paused state: **pause** and **continue**. Pause and continue commands may be issued: by an operator or by software (viz. an expert system).

**Pause:** when the command is issued the LVL1 triggers are blocked, by raising the global busy signal. All TDAQ elements are issued with Pause command. Each element will execute it locally as soon as the handling of the current event is terminated (i.e. TDAQ elements will not empty their buffers before entering the paused state.) TDAQ completes the transition to Paused as soon as all the TDAQ elements have entered the Paused state.

**Continue:** when the continue command is issued: all TDAQ elements are issued the continue command, each element returns to the running state. TDAQ completes the transition to the running state as soon as all the TDAQ elements have returned to the running state. At this point LVL1 triggers are unblocked.

Another special command will be available for a running TDAQ system, the Abort command. This command is reserved for very special cases and it entails a fast termination of the run; for example TDAQ elements will not complete the processing of events in their buffers.

### 3.3.7 Transition between Runs

Prior to the start of a run, or as the immediate consequence of a run stop command, the LVL1 Busy is asserted. The LVL1 Busy is removed upon the transition to the running state. This latter

implies that all TDAQ elements have completed their local execution of the run start command.

The completion of a run is also a process which needs synchronous local processing of all the TDAQ elements: they receive the stop command, complete the processing of the contents of their buffers, produce end of run statistics etc. and leave the running state.

In addition to the run control command, which signals a TDAQ element when a run is requested to complete, a mechanism is necessary to determine when the last fragment or event of the terminating run has been processed. This mechanism cannot be part of the run control as it is tightly related to the flow of the event data in the detector front-end buffers and in the TDAQ system. A time-out will be used for this purpose: a TDAQ element will consider that the last event has been processed when 1) it has received the 'stop run' command and 2) it has not received events for a certain time (for example a time of the order of 10 seconds).

The transition between two runs (i.e. stopping the previous and starting the next) includes two potentially time consuming processes:

- the completion of the processing of the contents of all the fragment/event buffers in the system: front-end buffers, RODs, ROBS, LVL2 and EF nodes;
- the synchronisation of all the TDAQ elements to complete the transition stopped/running or running/stopped. That is, before the TDAQ partition may complete a state transition, all the TDAQ elements have to have completed the transition locally.

Under certain conditions the values of some parameters such as LVL1 trigger masks, thresholds and pre-scaling factors or sub-detector calibration operating parameters, may need to change relatively often, maybe several times per machine fill, with each change forcing a new run.

This could happen in the case of calibration runs, when some detector operating parameter may be required to change frequently.

In these cases the transition between runs as defined in Section 3.3.6 is not adequate in terms of the potentially long TDAQ system down time. A more efficient transition between runs is required and we define:

#### Checkpoint

a transition in a running TDAQ system, triggered by a change in conditions or by an operator, which 1) results in the following events to be tagged with a new run number and 2) does not need the synchronisation, via run control start/stop commands, of all TDAQ elements.

The checkpoint transition is intended for those changes in conditions which require that events be correlated to the new conditions via a new run number but the change has a light implication on most of TDAQ. It is a mechanism to associate a new run number to events characterised by new conditions with minimal synchronisation within TDAQ.<sup>2</sup>

1. It maybe envisaged that, in the case of the LVL2 and the EF, only a (to be defined) percentage of the farm needs to successfully perform the transition. The rest may do it 'in the background' and join the new run afterwards.

2. It should be noted that, for a transient time, events belonging to more than one run could be simultaneously present in the system. In particular given that LVL2 accepts are not time ordered, an EF node might have to process events belonging to two (or in principle even more) different runs.

A checkpoint transition is started automatically by the TDAQ control system when certain conditions are modified; it may also be initiated manually by an operator or automatically by some other software component (viz. an expert system). The level-1 triggers are blocked upon entering the checkpoint transition and re-enabled prior to completing the checkpoint transition.

The main feature of the checkpoint transition is the fact that events keep flowing in the system continuously. Therefore a mechanism is needed for a TDAQ element to detect when the new run begins. That is when the new run number becomes applicable, when the Global Event ID should be reset to 0 and when a TDAQ element should perform run completion processing and the initialisation necessary for a new run (for example a LVL2 processor may require to read the new conditions). The run number may be used for this purpose, i.e. a TDAQ element recognises a new run whenever a piece of data (fragment or full event) is tagged with a new run number. TDAQ elements may therefore perform the 'transition' from the old to the new run at their own pace and time. It is remarked that the same mechanism is also applicable to analysis and monitoring software dealing with a statistical sample of the event data: e.g. a monitoring program recognises a new run whenever it samples an event with a new run number (with the caveat that, as for EF processing units, programs sampling events after LVL2 might have to handle events belonging to more than one run).

### 3.4 Partitions and related operations

A list of the different ways the TDAQ system may be subdivided follows; each definition corresponds to a specific function [3-2].

- **TTC Partition.** A TTC partition includes a part of the TTC system and a corresponding part of the ROD-BUSY feedback tree. A TTC partition corresponds to a single TTCv1 module. The concept of a TTC partition is already present in the LVL1 system [3-3].
- **TDAQ resource.** A TDAQ resource is a part of the ATLAS TDAQ system which can be individually disabled (masked out of the ATLAS TDAQ) and possibly enabled, without stopping the data taking process. A single ROB and a single HLT processing unit are examples of TDAQ resources.
- **TDAQ segment.** A TDAQ segment is defined as a set of TDAQ system elements that can be configured and controlled independently from the rest of the TDAQ system. A TDAQ segment can be dynamically removed from / inserted into an active TDAQ partition without stopping the run. An event filter sub-farm and a single ROD crate are examples of TDAQ segments.
- **TDAQ partition.** It is a sub-set of the ATLAS TDAQ system for the purpose of data taking. The full function of the ATLAS TDAQ is available to a sub-set of the ATLAS detector. The data taking from the LAr EMB A sub-detector, including the corresponding TTC partition, the read-out associated to the EMB A sub-detector, part of the event filter sub-farm (to run e.g. calibration software) constitutes an example of TDAQ partition.

The last three definitions introduce three independent concepts for the ATLAS TDAQ system: resources can be disabled, segments can be removed and operated independently, and partitions are fully functional TDAQ systems running on a sub-set of the ATLAS detector. There

1. That is the segment is capable of receiving commands from the TDAQ control system.

are elements which are neither a resource nor a segment (for example the RoIB), therefore the classification above does not define a hierarchy within the ATLAS TDAQ.

The term **partition** is reserved for the concept of a TDAQ partition. An equivalent formulation for a TDAQ partition is that the TDAQ system must be capable of running as multiple (fully functional), possibly concurrent, instances each operating on sub-sets of the ATLAS detector. There is a direct correspondence between TDAQ partitions and TTC partitions: these latter define how TDAQ is physically partitionable. For example the LAr sub-detector has six TTC partitions associated to it, hence no more than six independent TDAQ partitions may be run concurrently on the LAr detector.

There exists one TDAQ Partition which covers the whole ATLAS TDAQ system. That TDAQ Partition is used for physics data taking at the experiment. A TDAQ Partition always includes some FE elements of one or more sub-detectors in order to provide data<sup>2</sup>. A TDAQ Partition may stop at the level of one (or more) ROD crate(s) (ROD Crate DAQ), one ROS, one or more SFIs or one or more Event Filter sub-farms.

TDAQ partitions are properly (i.e. such that they result in a system which is capable of data taking) defined sets of TDAQ components. TDAQ partitions may be:

- Defined: the process of relating together the required TDAQ components in order to obtain a runnable system, including the definition of the sub-set of detector read-out associated to the TDAQ partition. The definition process will make sure that the definition of the TDAQ partition is consistent (i.e. it contains all that is needed). At the level of the definition, there is no need for different TDAQ partitions to be disjoint; for example two different TDAQ partitions may be defined to share parts of TDAQ (e.g. the read-out or part of the event filter farm).
- Activated: a defined TDAQ partition may be activated, this means that the TDAQ components associated to it are booked for use. In this case the system will check that the TDAQ partition being activated will not require any component which is already booked by another active TDAQ partition. In other words TDAQ partitions are required to be independent at the time of activation.
- Deactivated: the booking of the TDAQ components associated to the TDAQ partition is released. Other TDAQ partitions that may need those elements can at this moment be activated.
- Joined: the components from two (or more) existing (i.e. defined) TDAQ partitions can be merged together in order to make a larger (i.e. including more sub-detectors) TDAQ partition.
- Split: this is the reverse operation, with respect to joining TDAQ partitions. Two, or more, smaller TDAQ partitions are created out of an existing one.

It is remarked that the 'Join' and 'Split' operations do not affect the pre-existing TDAQ partitions: that is to say those which are merged and, respectively, split.

1. That is the complete functionality of the DAQ system is available to run a subset of the detector.

2. In one exceptional case, that of the DAQ partition, the TDAQ partition may include simulated input data instead of FE elements.

### 3.5 Operations outside a run

Outside a run, the operations allowed on the TDAQ system fall into two main categories: those operations which are performed between runs (with or without the LHC machine on) and those which are performed during the LHC shutdown period. More detail is available in Chapter 12.

**Operations between runs:** they typically fall in the range of initialisation (e.g. firmware loading), configuration (e.g. setting up of application parameter values) and partition management.

**Operations during shutdown:** there will be the need to run the TDAQ system for calibration, commissioning and test purposes, and the need for continuous operation of the DCS system.

### 3.6 Error handling strategy

The ATLAS TDAQ system will consist of a large number of hardware and software elements: a few thousand processors, each running possibly several software processes. Today a model for the Mean Time To Failure (MTTF) of the full TDAQ, or any of its components, is not available. However it is safe to assume that malfunctioning<sup>1</sup> in a system of such a size may happen at a non negligible rate. Under this assumption and taking into account the requirement of maximising the TDAQ up-time, a two-pronged strategy to address faults in the system is presented. The distinction is made between faults which are, respectively are not, fatal for a data taking session.

- The fault happens in an element in such a way that this latter can be removed from the running system without affecting the physics, that is to say once the element is removed, it is still meaningful to continue the run. It is the responsibility of the sub-system, to which the element belongs, to remove the element transparently without stopping the run. When necessary the sub-system will tag subsequent events with a 'quality flag' which marks events as 'degraded'. Examples are: a ROD, a ROB (both require the tagging with a 'quality flag'), a LV12 or an EF processor or even an entire farm (which do not require the quality flag).
- The fault happens in an element which is either essential (e.g. the DFM or the RoIB of the baseline) or such that it must respond to a high rate of requests (e.g. the ROS today). A fault in one of these elements is either fatal for the run or it may potentially generate a long and disrupting sequence of errors in related parts of TDAQ (for example, a ROS which fails to respond will generate a large number of time-out errors in the LV12 system, which in the most optimistic scenario will degrade performance). The 'simpler' fault tolerance as defined above (i.e. the 'self-healing' capability of a sub-system) is not applicable in this case. These TDAQ elements have to be identified and ought to be designed with a higher degree of reliability (i.e. predicting a reasonable MTTF for them).

1. Hardware fault (e.g. a faulty fan, power supply, disk, etc.) or software fault (e.g. a process aborting).

### 3.7 Data bases

The issue of data bases is central to the whole ATLAS TDAQ system, as the means to permanently record data (event data but also the detector and machine status) and to permanently hold the information necessary to initialise, configure and run the system. In this respect, and as discussed in Section 1.4, there is a number of broad categories of data to be permanently stored:

- Configuration data: information necessary to the configuration of TDAQ components and the related software as well as the ATLAS detector hardware. The management of this information is under the responsibility of TDAQ. The configuration information is used prior to the start of a run, during the TDAQ initialisation and configuration phases and while the run is being started. The configuration information is mostly static during data taking will only be changed in the case of serious hardware and/or software problems. In this latter case the TDAQ components which need the updated information will be notified of the changes (so as to be able to reconfigure themselves).
- Conditions data: this is, in some sense, the 'offline database', that is to say it contains all the information necessary to the reconstruction and analysis software as well as the information concerning the detector behaviour (as recorded by DCS). In particular it contains information necessary for the initialisation and correct functioning of the HLT algorithms. The responsibility for this database is outside TDAQ, the latter being a user of the database. TDAQ acts both as a consumer of the conditions database, as regards initialisation and configuration of the HLT processes for example, and a producer, in the case of DCS and calibration procedures (both produce information, e.g. detector status, which has to be stored as conditions).

- Event data: the data relative to the events produced in the ATLAS detector. This information is produced by TDAQ, which is responsible to record them on local, permanent storage. The contents of the local, permanent storage are transferred later (possibly asynchronously with respect to the data taking process) to an ATLAS central permanent event data repository.
- Monitoring data: TDAQ performs operational (i.e. of TDAQ itself) and event (i.e. of the detector) monitoring. Results, for example in the form of histograms, will be stored for later use (e.g. comparisons).
- Logbook data: the historical record of the experiment which includes the information produced by TDAQ, e.g. state transition, and via TDAQ, e.g. error conditions.

The amount of potential data producers and consumers, that is to say the total number of TDAQ components which are users of data bases, is of the order of several thousands (from ROD crates to Event Filter processors). Each is expected to consume and/or produce variable amounts of data (from kbytes to several tens of Mbytes): an order of magnitude view of the problem, for some TDAQ component, is shown in Table 3-1.

### 3.8 References

- 3-1 ATLAS TDAQ/DCS Global Issues Working Group, Run and States, ATLAS Internal Note, ATLAS-COM-DAQ-2003-004 (2003)
- 3-2 ATLAS TDAQ/DCS Global Issues Working Group, Partitioning, ATLAS Internal Note, ATLAS-COM-DAQ-2003-005 (2003)

**Table 3-1** Configuration and conditions data volume requirements for some TDAQ components

Component	Number (order of magnitude)	Configuration data		Operational monitoring data rate
		Volume at individual component	Volume at individual component	
ROD Crate	100	few kbytes	N/A	O(1) kbyte/s
ROS	150	few kbytes	N/A	O(1) kbyte/s
LVL2 Processing Unit	500	few kbytes	50 Mbyte	O(1) kbyte/s
Event Filter Processing Unit	1600	few kbytes	100 Mbyte	O(1) kbyte/s

3-3 ATLAS First-Level Trigger Technical Design Report, CERN/LHCC/98-14 (1998)

## 4 Physics selection strategy

This chapter provides an overview of the strategy for the online selection of events in ATLAS. The challenge faced at the LHC is to reduce the interaction rate of about 1 GHz at the design luminosity of  $1 \times 10^{34} \text{ cm}^{-2} \text{ s}^{-1}$  online by about seven orders of magnitude to an event rate of O(100 Hz) going to mass storage. Although the emphasis in this document will be on the contribution of the HLT to the reduction in rate, the final overall optimization of the selection procedure also includes LVL1.

The first section describes the requirements defined by the physics programme of ATLAS. This is followed by a discussion of the approach taken for the selection at the HLT and LVL1 triggers. Next a brief overview of the major selection signatures and their relation to the various detector components of ATLAS is given. Then, an overview of the various parts of the trigger menu for running at an initial luminosity of  $2 \times 10^{33} \text{ cm}^{-2} \text{ s}^{-1}$  is presented, together with a discussion of the expected physics coverage. The discussion in this chapter concentrates on the initial luminosity regime; the selection strategy for the design luminosity phase will crucially depend on the observations and measurements during the first years of data taking. This is followed by a description of how changes in the running conditions are going to be addressed, and finally ideas for the strategy of determining trigger efficiencies from the data alone are presented.

Details on the implementation of the event-selection strategy, in terms of the software framework to perform the selection, can be found in Section 9.5. More information on selection-algorithm implementations and their performance in terms of signal efficiency and background rejection are given in Chapter 13. Finally, Chapter 14 addresses the issue of system performance of the online selection, presenting our current understanding of the resources (e.g. CPU time, network bandwidth) needed to implement the selection strategy presented in this chapter.

### 4.1 Requirements

The ATLAS experiment has been designed to cover the physics in proton-proton collisions with a centre-of-mass energy of 14 TeV at LHC. Amongst the primary goals are the understanding of the origin of electroweak symmetry breaking, which might manifest itself in the observation of one or more Higgs bosons, and the search for new physics beyond the Standard Model. For the latter it will be of utmost importance to retain sensitivity to new processes which may not have been modelled. The observation of new heavy objects with masses of O(TeV) will involve very high- $p_T$  signatures and should not pose any problem for the online selection. The challenge is the efficient and unbiased selection of lighter objects with masses of O(100 GeV). In addition, precision measurements of processes within and beyond the Standard Model are to be made. These precision measurements will also provide important consistency tests for signals of new physics. An overview of the variety of physics processes and the expected performance of ATLAS can be found in [4-1]. Most of the selection criteria used in the assessment of the physics potential of ATLAS are based on the selection of at most a few high- $p_T$  objects, such as charged leptons, photons, jets (with or without b-tagging), or other high- $p_T$  criteria such as missing and total transverse energy. Furthermore, ATLAS expects to take data during the heavy-ion running of the LHC.

The online event-selection strategy has to define the proper criteria to cover efficiently the physics programme foreseen for ATLAS, while at the same time providing the required reduction in event rate at the HLT. Guidance on the choice of online selection criteria has been obtained from

the variety of analyses assessing the ATLAS physics potential, aiming for further simplification to a very few, mostly inclusive, criteria.

Event selection at LHC faces a huge range in cross-section values for various processes, as shown in Figure 4-1. The interaction rate is dominated by the inelastic part of the total cross-section with a cross-section of about 70 mb. The inclusive production of b-quarks occurs with a cross-section of about 0.6 mb, corresponding to a rate of about 6 MHz for design luminosity. It is worth noting that the cross-section for inclusive W production, including the branching ratio for the leptonic decays to an electron or a muon, leads to a rate of about 300 Hz at design luminosity. The rate of some rare signals will be much smaller, e.g. the rate for the production of a Standard Model Higgs boson with a mass of 120 GeV for the rare-decay mode into two photons will be below 0.001 Hz. The selection strategy has to ensure that such rare signals will not be missed, while at the same time reducing the output rate of the HLT to mass storage to an acceptable value.

The online selection thus has to provide a very efficient and unbiased selection, maintaining the physics reach of the ATLAS detector. It should be extremely flexible in order to operate in the challenging environment of the LHC, with up to about 20 inelastic events per bunch crossing at design luminosity. Furthermore, it has also to provide a very robust, and, where possible, redundant selection. It is highly desirable to reject fake events or background processes as early as possible in order to optimize the usage of the available resources. Presently the selection is based on rather simple criteria, while at the same time making use of the ATLAS capabilities to reject most of the fake signatures for a given selection. It is, however, mandatory to have additional tools such as exclusive criteria or more elaborate object definitions available for the online selection.

### 4.2 Selection criteria

In order to guarantee optimal acceptance to new physics within the current paradigm of particle physics, we have taken an approach based on emphasizing the use of inclusive criteria for the online selection, i.e. having signatures mostly based on single- and di-object high- $p_T$  triggers. Here 'high- $p_T$ ' refers to objects such as charged leptons with transverse momenta above O(10 GeV). The choice of the thresholds has to be made in such a way that a good overlap with the reach of the Tevatron and other colliders is guaranteed, and there is good sensitivity to new light objects, e.g. Higgs bosons. Enlarging this high- $p_T$  selection to complement the ATLAS physics potential requires access to signatures involving more exclusive selections, such as rejecting the presence of several different physics objects or the use of topological criteria. A fur-

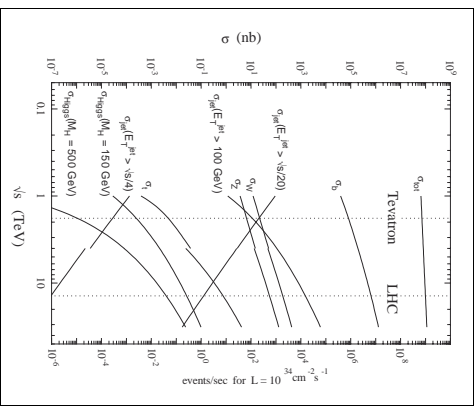

Figure 4-1 Cross-section and rates (for a luminosity of  $1 \times 10^{34} \text{ cm}^{-2} \text{ s}^{-1}$ ) for various processes in proton-proton collisions, as a function of the centre-of-mass energy.

ther example is the use of charged particles with transverse momenta of  $O(1 \text{ GeV})$  for the selection of b-hadron physics.

The selection at the HIT will in most cases be seeded by the information already obtained at LVL1 (i.e. Regions-of-Interest, RoIs) and will exploit the complementary features of the LVL2 trigger and the EF selection. At LVL2, a fast rejection has to be achieved, using dedicated algorithms to meet the latency constraints. These algorithms will, in most cases, require only a few per cent of the event data, thanks to the guidance of RoIs from LVL1. The selection signatures will be refined at the EF, where the full event is available for analysis, using more precise and detailed calibration and alignment parameters and having fewer constraints on the latency. Also the EF processing can profit from the results of the earlier trigger stages, for example, using the results of LVL2 for seeding the EF processing. Furthermore, the EF will provide classification of the accepted events, in order to facilitate offline analyses. This might involve the reconstruction of further objects, which are not used for the event selection.

Although the selection will be predominantly based on simple and inclusive signatures to allow for optimization at the analysis level, more refined selection tools have to be used in addition. These include the use of more elaborate algorithms, e.g. b-tagging of jets, and the application of more exclusive criteria, in order to enrich the available samples for certain physics processes, for example. Furthermore, it is highly desirable to select events with several complementary criteria, in order to better control possible biases due to the online selection.

### 4.3 Physics objects for event selection

The ATLAS trigger relies on the concept of physics 'objects' (muons, electrons, jets, etc.). Candidate objects are typically first identified and crudely reconstructed at LVL1. Processing in the HIT progressively refines the reconstruction, rejecting fake objects and improving the precision on measured parameters such as  $E_T$ .

The physics objects used in the HIT can be based on information from all sub-detectors of ATLAS, at full granularity. As mentioned above, the difference in the reconstruction of these objects between LVL2 and the EF refers mostly to the complexity of the algorithms interpreting the raw data, and on the level of detail and accuracy of the alignment and calibration information used. The EF has the full event at its disposal to the search for these objects, although it is anticipated that the processing will typically be initiated using the detailed LVL2 result to seed the algorithms.

ATLAS, as a multi-purpose detector, will have charged-particle tracking in the Inner Detector covering the pseudorapidity region of  $|\eta| < 2.5$  inside a solenoidal magnetic field of 2 T and fine-grained calorimeter coverage for  $|\eta| < 2.4$ , especially in the electromagnetic compartments, which extends up to  $|\eta| < 3.2$ . The forward calorimeter completes the calorimetric coverage up to  $|\eta|$  of 4.9 for the measurement of missing transverse energy, and forward jets. The coverage of the muon system extends up to  $|\eta| = 2.4$  for the trigger chambers and up to  $|\eta| = 2.7$  for the precision muon chambers. More details on the various components and their expected performance can be found in [4-1].

The following overview briefly summarizes the most important physics objects foreseen for use in the HIT. More details on the concrete implementation of the selection algorithms and their expected performance are given in Chapter 13.

- Electron (within  $|\eta| < 2.5$ ): the selection criteria for electrons will include a detailed shower-shape analysis in the fine-grained electromagnetic compartments of the LAr calorimeters (within the range of  $|\eta| < 2.4$ ), a search for high- $p_T$  tracks, and a match between the clusters and tracks. Further refinement is possible via the identification and correct treatment in case the electron has undergone Bremsstrahlung, the requirement of a transition radiation signal from the transition radiation tracker (TRT), and the application of isolation criteria.
- Photon (within  $|\eta| < 2.5$ ): the selection of photons will also be based on a detailed calorimeter shower-shape analysis, including the requirement of isolation, and possibly on the use of a veto against charged tracks, after it has been checked that the photon did not convert in the material of the Inner Detector into an  $e^+e^-$  pair.
- Muon (within  $|\eta| < 2.4$ ): the muon selection will in a first step make use of the external muon spectrometer to determine the muon momentum and charge. A refinement of this information will then be obtained by searching for tracks in the Inner Detector and matching and combining these candidates with the muon track segment. Isolation criteria may also be applied, using, for example, information from the calorimeters.
- Tau (within  $|\eta| < 2.5$ ): the selection of taus in their hadronic decay modes will use calorimeter shower-shape analysis to identify narrow hadronic jets. These can be matched to one or more tracks found in the Inner Detector. As above, isolation criteria may also be applied, using, for example, information from the calorimeters.
- Jet (normally within  $|\eta| < 3.2$ ): the jet selection will be based mostly on calorimeter information, which might be refined by including the information from matching charged tracks. A search can also be made for jets in the forward calorimeter, covering  $3.2 < |\eta| < 4.9$ .
- b-tagged jet (within  $|\eta| < 2.5$ ): the selection will start from jets already selected. The associated tracks found in the Inner Detector are used to search, for example, for large values of the impact parameters or for the presence of secondary vertices, and/or for soft (i.e. low- $p_T$ ) leptons.
- $E_{T, \text{miss}}$  (within  $|\eta| < 4.9$ ): the definition of missing transverse energy will be based on the full calorimeter data, allowing for improvements via the inclusion of information from observed muons.
- Total  $\Sigma E_T$  (within  $|\eta| < 4.9$ ): again the calculation will be based on the full calorimeter information, with additional corrections possible from reconstructed muons. An alternative definition of the total  $\Sigma E_T$  can be obtained using only reconstructed jets.

An example of an exclusive selection, which requires a complex approach, is the case of b-hadron physics. Here it is necessary to reconstruct online in a (semi-)exclusive way the b-hadron decay modes of interest. This requires the reconstruction and identification of low- $p_T$  charged hadrons and leptons (electrons and muons), where guidance from LVL1 is not always available with optimal efficiency. At LVL1 the trigger will demand the presence of at least one low- $p_T$  muon.

## 4.4 Trigger menu

In this section, the present understanding of the trigger menu for running at an initial peak luminosity of  $2 \times 10^{33} \text{ cm}^{-2} \text{ s}^{-1}$  is presented. Distinction is made between different parts of this trigger menu which are discussed separately:

- inclusive physics triggers, which form the backbone of the online selection and are chosen to guarantee the coverage of a very large fraction of the ATLAS physics programme;
- prescaled physics triggers, which will extend the physics coverage for ATLAS, by having, for example, inclusive selections with lower thresholds to enlarge the kinematic reach, and provide samples for understanding background processes and detector performance;
- exclusive physics triggers, which will also extend the physics coverage for ATLAS; and
- dedicated monitor and calibration triggers, not already contained in one of the above items, for improving the understanding of the performance of the ATLAS detector, based on physics events not needed otherwise for physics measurements. Furthermore, specific selections might be used to monitor the machine luminosity.

The description of these four parts of the current trigger menu is followed by a discussion of the physics coverage achieved, including indications about dependence of the acceptance for several physics processes on the threshold values. A more detailed discussion of the various parts of the trigger menu can be found in [4-4].

The derivation of the trigger menus and the threshold values starts from the physics-analysis requirements, followed by an assessment of the rejection capabilities at the various selection stages, and finally taking into account estimates of the total HLT output bandwidth. This procedure is iterative in order to include existing information, e.g. from studies of the LVL1 trigger (see Ref. [4-2]), or from past studies of the HLT performance, as documented, for example, in Ref. [4-3].

Not discussed in any detail in this document are possible trigger selections for the study of very-forward physics or heavy-ion interactions, as these additional aspects of the ATLAS physics potential are presently only under investigation. The flexibility in the online selection will, however, allow these physics processes to be addressed. As the excellent capabilities of ATLAS for identifying high- $p_T$  signatures are expected to play an important role in the study of these physics processes (especially for the study of heavy-ion interactions), the selection strategy in this document should be extremely useful for these environments as well.

It should be noted that the menus will evolve continuously, benefiting from a better understanding of the detector, and the experience gained when commissioning the experiment. Further progress in the understanding of the Standard Model and future discoveries prior to the start of the LHC might influence the contents of the trigger menu.

In the narrative that follows, labels of the form 'NoXXi' will be used to identify specific trigger items. Here 'N' is the minimum number of objects required, and 'o' indicates the type of the selection ('e' for electron, 'γ' for photon, 'μ' for muon, 'τ' for a τ hadron, 'j' for jet, 'b' for a b-tagged jet, 'XE' for missing transverse energy, 'E' for total transverse energy, and 'JE' for the total transverse energy obtained using only jets), 'XX' gives the threshold in transverse energy (in units of GeV), and 'i' indicates an isolation requirement. As an example, 2μ20i refers to the requirement of at least two muons, with an  $E_T$  threshold of 20 GeV each, fulfilling isolation criteria. The thresholds indicate the transverse-energy value above which the selection has good efficiency for true objects of the specified type. The exact value for the efficiency obtained depends on the

implementation of the algorithm and the details of the criteria applied, examples of which are given in Chapter 13.

A comprehensive assessment of the expected rates for the trigger menu will be given in Section 13.5, both for LVL1 and for the HLT, including the expected total data rate for recording the accepted events to mass storage.

### 4.4.1 Physics triggers

Table 4-1 gives an overview of the major selection signatures needed to guarantee the physics coverage for the initial running at a peak luminosity of  $2 \times 10^{33} \text{ cm}^{-2} \text{ s}^{-1}$ .

**Table 4-1** Trigger menu, showing the inclusive physics triggers. The notation for the selection signatures and the definition of the thresholds are explained in Section 4.4.

Selection signature	Examples of physics coverage
e25i	$W \rightarrow e\nu, Z \rightarrow ee$ , top production, $H \rightarrow WW^{(*)}/ZZ^{(*)}, W, Z$
2e15i	$Z \rightarrow ee, H \rightarrow WW^{(*)}/ZZ^{(*)}$
μ20i	$W \rightarrow \mu\nu, Z \rightarrow \mu\mu$ , top production, $H \rightarrow WW^{(*)}/ZZ^{(*)}, W, Z$
2μ10	$Z \rightarrow \mu\mu, H \rightarrow WW^{(*)}/ZZ^{(*)}$
γ60i	direct photon production, $H \rightarrow \gamma\gamma$
2γ20i	$H \rightarrow \gamma\gamma$
μ400	QCD, SUSY, new resonances
2330	QCD, SUSY, new resonances
3j165	QCD, SUSY
4j110	QCD, SUSY
6b0	charged Higgs
μ10 + e15i	$H \rightarrow WW^{(*)}/ZZ^{(*)}, \text{SUSY}$
e35 + xE45	$q\bar{q}H(\tau\tau), W \rightarrow \tau\nu, Z \rightarrow \tau\tau, \text{SUSY}$ at large $\tan\beta$
γ70 + xE70	SUSY
xE200	new phenomena
E1000	new phenomena
JE1000	new phenomena
2μ6 + μ <sup>+</sup> τ <sup>-</sup> + mass cuts	rare b-hadron decays ( $B \rightarrow \mu\mu X$ ) and $B \rightarrow J/\psi(\psi')X$

A large part of the physics programme will rely heavily on the inclusive single- and di-lepton triggers, involving electrons and muons. Besides selecting events from Standard Model processes — such as production of W and Z bosons, gauge-boson pairs, tt pairs, and the Higgs boson — they provide sensitivity to a very large variety of new physics possibilities, for example new heavy gauge bosons ( $W', Z'$ ), supersymmetric particles, large extra dimensions (via the Drell-

Yan di-lepton spectrum), and Higgs bosons in extensions of the Standard Model such as the MSSM. These triggers also select particle decays involving  $\tau$ 's where the  $\tau$  decays leptonically. The inclusive single- and di-photon triggers will select a light Higgs boson via its decay  $H \rightarrow \gamma\gamma$  as well as some exotic signatures (e.g. technicolour).

The coverage for supersymmetry is extended by using the jet + missing-transverse-energy signatures as well as multi-jet selections: the multi-jet selection is especially relevant in case of R-parity violation. The inclusive single- and di-jet triggers will, for example, be used in the search for new resonances decaying into two jets. Further sensitivity to supersymmetry at large values of  $\tan \beta$  will be provided by signatures involving a hadronic  $\tau$  selection.

Rare b-hadron decays and b-hadron decays involving final states with a  $1/\psi$  are selected by a di-muon signature (requiring opposite charges) and additional invariant-mass cuts.

#### 4.4.2 Prescaled physics triggers

Table 4-2 shows a prototype for additional contributions to the trigger menu in the form of prescaled physics triggers. These triggers extend the physics coverage of the online selection by extending the kinematic reach of various measurements towards smaller values, e.g. of the transverse momentum in a process.

Table 4-2. Examples of additional prescaled physics triggers

Selection signature	Examples of physics motivation
single jets (8 thresholds between 20 and 400 GeV)	inclusive jet cross-section measurement
di-jets (7 thresholds between 20 and 350 GeV)	di-jet cross-section measurements
three jets (6 thresholds between 20 and 165 GeV)	multi-jet cross-section measurements
four jets (5 thresholds between 20 and 110 GeV)	multi-jet cross-section measurements
single electrons (5–6 thresholds between 7 and 25 GeV)	inclusive electron cross-section
di-electrons (2 thresholds between 5 and 15 GeV)	
single muons (6 thresholds between 5 and 20 GeV)	inclusive muon cross-section
di-muons (2 thresholds between 5 and 10 GeV)	
single photons (7–8 thresholds between 7 and 60 GeV)	inclusive photon cross-section
di-photons (2 thresholds between 7 and 20 GeV)	
taus (4 thresholds between 25 and 60 GeV)	
di-tau (2 thresholds between 25 and 35 GeV)	$Z \rightarrow \tau\tau$ selection
$\chi E$ (3 thresholds between 45 and 200 GeV)	
$E$ (3 thresholds between 400 and 1000 GeV)	
$\mu E$ (3 thresholds between 400 and 1000 GeV)	
filled-bunch-crossing random trigger	minimum bias events, trigger efficiency

A typical example for the application of these trigger selections is the measurement of the jet cross-section over the full kinematic range, starting from the lowest achievable  $E_T$  values up to the region covered by the un-prescaled inclusive jet trigger. In addition, these pre-scaled triggers together with the pre-scaled minimum bias selection, will be crucial in determining trigger efficiencies from the data, as discussed in Section 4.6.

The prescale factors to be applied to most of the selections shown in Table 4-2 will have to be determined on the basis of the desired statistical accuracy for the given application, taking into account the total available data bandwidth and computing resources. The  $E_T$  ranges for the thresholds should be seen as indicative only. The aim will be to cover the widest possible range, i.e. extending the coverage from the thresholds un-prescaled selections down to the lowest possible ones for a given signature. The values of the prescale factors will evolve with time. These triggers will be of particularly high importance in the early phases of the data taking after the start-up of the LHC.

#### 4.4.3 Exclusive physics triggers

A list of further selections using more exclusive criteria is presented in Table 4-3.

Table 4-3. Examples of additional exclusive physics triggers

Selection signature	Physics motivation
$e20l + \chi E25$	$W \rightarrow e\nu$
$\mu20 + \gamma10l$	lepton flavour violation
$e/\mu + \text{jet}$	
forward jet + $\chi E$	invisible Higgs decays
b-jet (various multiplicities)	
$\mu8 + B$ -decays	b-hadron physics

An example is the extension of the selection for b-hadron physics to involve more decay modes. As discussed in more detail in Ref. [4-1] and Ref. [4-3], ATLAS offers the possibility of performing several measurements of CP-violation in the b-hadron system. The selection strategy relies on selecting  $b\bar{b}$  production via the semi-muonic decay of one of the b-quarks, and then making a (semi-)exclusive selection of the decays of interest based on reconstructing low- $P_T$  charged particles in the Inner Detector. The best efficiency would be achieved by reconstructing the tracks at LVL2 without guidance from LVL1. However, in view of resource limitations, Rol-driven reconstruction is also being considered.

For the first data taking, it will be essential that the full detector is read out to mass storage for all triggers in order to have the full spectrum of information available for offline studies. It is, however, envisaged that at a later stage some of the above prescaled triggers might no longer require recording of the full detector information, and thus more bandwidth could be made available for further selection criteria.



#### 4.4.4 Monitor and calibration triggers

The selection signatures presented in Table 4-1, Table 4-2 and Table 4-3 will provide a huge sample of physics events which will be of extreme importance for the understanding and continuous monitoring of the detector performance. In particular, the leptonic decays of the copiously-produced Z bosons will be of great help. One will use  $Z \rightarrow ee$  events to determine the absolute energy scale for electrons and to intercalibrate the electromagnetic parts of the calorimeter. The muonic decay will set the absolute momentum scale, both in the Inner Detector and in the muon spectrometer. In addition, the inclusive electron and muon triggers will select  $t$  events via the semi-leptonic decay of one of the top quarks. This sample can be used to set the jet energy scale, using di-jet decays of the  $W$ 's produced in the top quark decays, and also to determine the  $b$ -tagging efficiency.

**Table 4-4** Examples of specific monitor and calibration triggers, based on physics events, which are not covered in Table 4-1, Table 4-2 and Table 4-3

Selection signature	Example for application
random trigger	zero bias trigger
unpaired-bunch-crossing random trigger	background monitoring
e25i loose cuts	trigger monitoring
e25	trigger monitoring
$\mu$ 20i loose cuts	trigger monitoring
$\mu$ 20	trigger monitoring
$\gamma$ 60i loose cuts	trigger monitoring
$\gamma$ 60	trigger monitoring
$\tau$ 60 loose cuts	trigger monitoring
$e^+e^- + Z$ mass, loose cuts	monitor flavour subtraction
$\mu^+\mu^- + Z$ mass, loose cuts	monitor flavour subtraction
$\mu^+\mu^- + Y$ mass	calibration

Large inclusive samples of muons are the starting point for the Inner Detector alignment: these will also be used to study energy loss in the calorimeters and to align the muon detectors. Large inclusive samples of electrons will be used to understand the electromagnetic energy scale of the calorimeter, using the precise momentum measurements from the Inner Detector, and to understand the energy-momentum matching between the Inner Detector and the calorimeter. The calorimeter inter-calibration, especially for the hadronic part, will benefit from inclusive (di-)jet samples by making use of the energy-balance technique.

Further examples of specific monitor and calibration triggers are given in Table 4-4. The random trigger on unpaired bunch crossing will select bunch crossings, where only one of the two packets is actually filled, and can thus be used to monitor beam-related backgrounds. The selection of oppositely charged lepton pairs, with an invariant mass compatible with the Z-boson mass, and loose cuts (especially on the isolation, which should be in this case defined identical for electrons and muons), will be an important control sample for the analyses where the contribution from different (lepton) flavours needs to be compared.

Monitor and calibration triggers provide examples of selections which do not always require the full detector information to be read out to mass storage. For some monitoring aspects, it could be envisaged to record only the results of the processing of the event in the EF, and not to store the raw data. However, it is anticipated that this would only be done after stable operation of the detector and the machine has been reached.

#### 4.4.5 Physics coverage

In this section, examples will be given to indicate the sensitivity of the physics coverage to the thresholds used in the selection signatures. Indications on the redundancy achieved by the full set of selection signatures proposed are also given.

As an example, the search for the Standard Model Higgs boson in the decay mode to  $H \rightarrow b\bar{b}$  will be discussed, where  $H$  is produced in association with a  $t\bar{t}$  pair. The proposed selection criteria for this mode involve the requirement of a lepton from the semi-leptonic decay of one of the top quarks. In Ref. [4-1], the study was based on the assumption of a lepton- $p_T$  threshold of 20 GeV for both electrons and muons. Table 4-5 shows the impact of raising one or both of these thresholds on the expected significance for signal observation.

**Table 4-5** Example of loss in significance for the associated production of  $t\bar{t}H$  (for a Standard Model Higgs boson with a mass of 120 GeV) for an integrated luminosity of 30 fb<sup>-1</sup>

$p_T(e) >$	20 GeV	25 GeV	30 GeV	30 GeV	35 GeV
$p_T(\mu) >$	20 GeV	20 GeV	20 GeV	40 GeV	25 GeV
$s/\sqrt{s}$	1	0.98	0.96	0.92	0.92

Another example is the inclusive single-photon trigger, with a present threshold of 60 GeV. This selection can be used to search for technicolour via the production of a techni-omega,  $\omega_T$ , which would be detected via its decay  $\omega_T \rightarrow \gamma\pi^0\pi^0 \rightarrow \gamma b\bar{b}$ . As shown in Ref. [4-1], for a mass  $M(\omega_T) = 500$  GeV, the offline analysis would make a cut on the photon transverse energy of  $E_T(\gamma) > 50$  GeV. This shows that a further raising of the single-photon threshold would impact the discovery potential. In addition, the overlap with the Tevatron reach up to techni-omega masses of about 400 GeV might not be assured.

Di-jet events will be used to search for new resonances decaying into two jets. The expected reach [4-5] of the CDF Experiment at Tevatron for an integrated luminosity of 15 fb<sup>-1</sup> should cover E6 di-quarks with masses up to 700 GeV, heavy  $W^*/Z$  bosons with masses up to 850 GeV, techni- $\rho$  mesons,  $p_T$  with masses up to 900 GeV, excited quarks  $q^*$  with masses up to 950 GeV, and axigluons with masses up to 1250 GeV. The transverse-energy spectrum of the jets from the decay of resonance with a mass in the range discussed above would lead to a Jacobian peak at 350-630 GeV in  $E_T$ . An inclusive single-jet trigger with  $E_T > 400$  GeV will not provide adequate coverage for this kinematic region and needs to be supplemented by a di-jet trigger with lower thresholds.

Further selections presently under study could enlarge the acceptance for some Higgs production and decay modes. The production of Higgs bosons via vector-boson fusion leads to the presence of non-central low- $p_T$  jets that can be used as a tag. Requiring that two such jets be present in an event and that they are separated significantly in rapidity could allow, for example, the lepton  $p_T$  thresholds to be lowered, and thus increase the significance for Higgs obser-

vation. A second, related example is the search for a Higgs boson with an invisible decay mode, where a trigger requirement of two tag jets and missing transverse energy could be used.

The overall optimization of the online selection will be refined until the first collisions are recorded. Experience with the first real data might well force one to significantly revise this optimization and, in any case, it will have to be refined continuously throughout the lifetime of the experiment. The following aspects have to be taken into account:

- the evolving understanding of physics;
- the effect of the foreseen thresholds on the acceptance for known (and unknown) physics processes;
- the rate of events after the selection (one should note that, even in the absence of fake signatures, there is a large rate of high- $p_T$  events that one would like to retain — e.g. W and Z leptonic decays);
- the inclusiveness of the selection (one should note that a more exclusive selection does not necessarily imply a significantly reduced output rate — selections for many final states will have to be considered in order to achieve good coverage); and
- the available resources for the online selection, and the subsequent offline storage and processing of the data.

Various possibilities are available to control the output rate of the HLT. These include changes to the threshold values, changes to, or introduction of, pre-scale factors, phasing in of more exclusive selections and, where possible, tightening of selection cuts in the physics-object definition. Some of these schemas can also be applied at LVL1 in order to reduce the input rate to the HLT in case insufficient resources for the treatment of the events are available.

It is important to keep in mind that less inclusive selections are targeted towards specific model predictions and are thus not desirable for unbiased searches for new physics. They will, however, be useful to increase the accumulated statistics for specific processes, e.g. when thresholds for the inclusive selection will have to be raised further. The introduction of additional biases at the trigger level due to less inclusive selection should be avoided where possible, since they might influence the accuracy of various precision measurements.

## 4.5 Adapting to changes in running conditions

An efficient mechanism is needed to adapt the trigger menu to changes in the running and operational conditions of the experiment. These changes will include a decrease in the luminosity during a coast, changes in machine-background conditions, and changes in detector performance affecting the selection criteria. Procedures must be put in place to react to these changes effectively and thus maintain a robust selection process. It is important to keep the correct history of all changes to the trigger configuration: this will be done by changing the run number whenever there is a significant change as discussed in Chapter 3.

## Luminosity changes

During a coast<sup>1</sup> in the LHC (estimated duration up to ~14 hours) the luminosity may drop by a factor of two or more. To take advantage of the available bandwidth and processing power in the HLT system, the trigger criteria should be adjusted to maintain an approximately constant event rate in the HLT. This could be achieved by including more trigger selections in the trigger menu, by reducing prescale factors for selections with lower- $p_T$  thresholds, by adding more exclusive selections, or even by changing, i.e. lowering, the thresholds of the inclusive physics triggers. In this way, the physics coverage of ATLAS will be extended during a coast. An example is the case of b-hadron physics, where the inclusive trigger menu discussed above for  $L = 2 \times 10^{33} \text{ cm}^{-2} \text{ s}^{-1}$  is restricted to select only final states with at least two oppositely-charged muons. As the luminosity drops below the initial peak value, other decay modes (e.g. fully hadronic or involving two low- $p_T$  electrons) could be added.

The sizeable change in luminosity during a coast will imply changes in the average number of pile-up events present in the same bunch crossing, which might influence the optimal choice of threshold values (or isolation cuts) for various criteria in the definition of the selection objects. More studies are needed to assess whether simple changes of prescale factors are sufficient. It is important to have an accurate monitoring of the luminosity, which possibly requires additional dedicated trigger selections.

## Background conditions

One will have to foresee adjustments for changes in the operating conditions, such as sudden increases in backgrounds or the appearance of hot channels, leading to certain triggers firing at a larger rate than is acceptable. Furthermore, machine-related backgrounds might increase suddenly and impact on the rate for certain selection signatures. Possible remedies in this case will be either to disable this selection or to significantly increase the prescale factor.

## Mechanisms for adaptation

From an operational point of view, changes to pre-scale values must be simple and quick, whereas changes to threshold values might imply more complex re-initialization procedures. Changes in the prescale factors could be done dynamically in an automated fashion, however, it might be preferable to perform these changes less frequently in order to simplify the calculation of integrated luminosities for cross-section measurements.

## Other remarks

The above list of changes in conditions is obviously incomplete and there will be many outside causes for changes to a stable operation, to which the online selection has to react and adapt in order to preserve the physics coverage of ATLAS.

## 4.6 Determination of trigger efficiencies

As far as possible, trigger efficiencies should be derived from the data. In this section, only a few basic ideas will be described, more details need to be worked out, e.g. addressing the statistical precision that can be obtained on the efficiency determination. No explicit distinction be-

<sup>1</sup> A coast is the period when there is beam after a machine fill.

tween LVLI and the HLT selections will be made, although the efficiency determination will be done separately for each trigger (sub-)level as well as globally. Furthermore, the efficiency of the selection must be monitored carefully throughout the lifetime of ATLAS, which implies that low-threshold triggers, from which the efficiencies are calculated, have to be kept running with pre-scale factors set to provide sufficient statistical precision. In the following, a qualitative overview of various possible procedures is given. The emphasis will be on trying to determine the efficiencies in several ways, in order to minimize systematic uncertainties.

#### Bootstrap procedure

One possibility is a 'bootstrap' procedure, starting off with a selection of minimum-bias events and using those to study the turn-on curve for very low- $E_T$  triggers on jets, electrons, photons, muons, and so on. Next, the turn-on curves for electron triggers with higher  $E_T$  thresholds, for example, are studied using samples of events selected by an electron trigger with the lower (and thus already understood) threshold. The same holds for all other object types.

#### Selection of objects by independent signatures

For the HLT, it will be possible to foresee selection of objects by independent signatures in order to study the trigger efficiency of a particular step in the selection sequence, e.g. by selecting a sample with high- $p_T$  inner-detector tracks in order to study the calorimeter or the muon trigger selections in more detail. Given the absence of a track trigger at LVLI, this will not be possible for the first stage of the selection.

#### D-object samples

A further possibility is to use di-object samples which have been selected online by an inclusive single-object requirement and then reconstructed offline. These events can be used to study the trigger response for the second object, which was not required for the online selection. Examples of samples that can be used to study the lepton-trigger efficiencies are  $Z \rightarrow \text{ll}$  decays which are plentifully produced, and also  $1/\psi \rightarrow \text{ll}$  or the  $Y \rightarrow \text{ll}$  decays which might prove very useful for the region of lower transverse momenta. The same technique can be applied to events where the two objects are of different types. For example, events with  $Z \rightarrow \text{ll}$  plus jets could be used to measure the efficiency of the jet trigger.

#### Required statistics

It cannot be emphasized enough that the amount of data needed to obtain a proper understanding of the online selection is not going to be negligible in the start-up phase and indeed throughout the lifetime of ATLAS. However, it will play an important role in assuring the potential of the experiment for discoveries and precision physics measurements. A detailed assessment of the expected needs will be done in the next couple of years. In the present menus only 10% of the total rate of the HLT is assigned to such triggers, which is smaller than the fractions used by current running experiments and might not be sufficient. During Tevatron Run I, as much as 30% of the accepted triggers at the second stage for CDF were pre-scaled physics (and calibration) triggers. In the case of D0, for the highest luminosities, about 20% of the triggers were pre-scaled and about 25% were monitoring and calibration triggers. Since D0 kept all thresholds fixed during a machine coast and only adjusted the pre-scale factors to always fill up the available bandwidth, the fraction of pre-scaled triggers increased towards the end of coast, where it could make up to 90% of the total rate.

## 4.7 References

- 4-1 ATLAS Detector and Physics Performance TDR, CERN/LHCC/99-14 and 99-15 (1999)
- 4-2 ATLAS First-Level Trigger TDR, CERN/LHCC/98-14 (1998)
- 4-3 ATLAS HLT, DAQ and DCS Technical Proposal, CERN/LHCC/2000-017 (2000)
- 4-4 T. Schoerner-Sadenius and S. Tapprogge (eds.), ATLAS Trigger Menus for the LHC Start-up Phase, ATL-COM-DAQ-2003-007
- 4-5 The CDF II Detector Technical Design Report, FERMILAB-Pub-96/390-E (1996)

## 5 Architecture

This chapter addresses the architecture of the ATLAS HLT/DAQ system. It starts with a description of how the HLT/DAQ system is positioned with respect to both the other systems of the experiment and external systems such as the LHC machine and CERN technical services. This is followed by a description of the organisation of the HLT/DAQ system in terms of the functions it provides and how they are organised in terms of sub-systems.

The system architecture, represented in terms of implementation independent components, each associated to a specific function, and their relationships is then presented, together with the mapping of the HLT/DAQ sub-systems onto the architecture. This generic architecture has also been used to evaluate the overall system cost, discussed in Chapter 16. Finally, the concrete implementation (baseline) of the architecture is described.

### 5.1 TDAQ context

The context diagram of the HLT/DAQ is shown in Figure 5-1. It illustrates the inter-relationships between the HLT/DAQ system seen as a whole and elements external to it which are directly related to data acquisition and triggering. It also illustrates the type of data which is exchanged in each case. The associated interfaces are introduced in Section 5.2.3, and discussed in more detail in Part 2 of the present document.

The LVL1 trigger provides LVL2 with RoI information needed to guide the LVL2 selection and processing; this interface is discussed in detail in Part 2. The TTC system [5-1] provides signals associated with events that are selected by the LVL1 trigger. RODs associated with the detectors provide event fragments for all events that are selected by the LVL1 trigger. In addition, the LVL1 system contains RODs which provide LVL1 trigger-decision data to be read out for the selected bunch crossings. The LVL1 trigger system, the TTC system and all the ROD systems need to be configured by the DAQ system, e.g. at the start of each run. These components are shown in Figure 5-1.

Interfaces to external systems are also illustrated in Figure 5-1. These connect to the LHC machine, e.g. to exchange information on beam parameters, to the detectors, e.g. to control voltages, to the experimental infrastructure, e.g. to monitor temperatures of racks, and to the CERN technical infrastructure (such as the rack cooling water supply). The TDAQ interface for all these external systems is the DCS. Also shown are the interfaces relating to: long-term storage of event data retained by the HLT prior to offline analysis; and non-event data which have to be stored; alignment and calibration constants; configuration parameters, etc.

### 5.2 HLT/DAQ functional analysis

This section analyses the HLT/DAQ system in terms of the basic required functions, the building blocks and sub-systems which provide these functions and their internal and external interfaces.

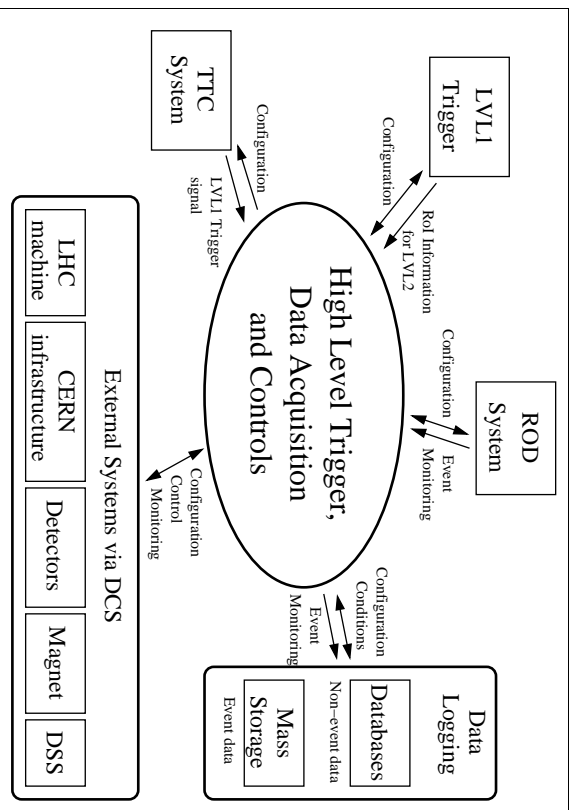

Figure 5-1 Context diagram

#### 5.2.1 Functional decomposition

The HLT/DAQ system provides the ATLAS experiment with the capability of: moving the detector data, e.g. physics events, from the detector to mass storage; selecting those events which are of interest for physics studies; and controlling and monitoring the whole experiment.

The following functions are identified:

- **Detector readout:** for events, i.e. bunch crossings, selected by the LVL1 trigger, the data associated with the relevant bunch crossing, are passed through detector-specific modules (RODs) which arrange them in formatted event fragments before sending them on to the HLT/DAQ system. An event arriving at the input to the HLT/DAQ system, i.e. at the ROBs, is therefore split in a number of fragments. Quantitatively, there are ~1600 RODs each of which sends one event fragment per event i.e. at the LVL1 rate of up to 100 kHz.
- **Movement of event data:** event fragments buffered in the ROBs have to be moved to the HLT and, for selected events, to mass storage. This is a complex process which involves both moving small amounts (typically ~2% of the full event) of data per event at the LVL1 trigger rate (data in Rols for the LVL2 trigger) and the full event, i.e. ~1.5 Mbyte, at the rate of the LVL2 trigger (few kHz).
- **Event selection and storage:** the HLT system is responsible for reducing the rate of events, and selecting those potentially of interest for offline analysis. Events selected by the HLT system are written to permanent storage for offline reconstruction and analysis. The data rate for selected events should not exceed a manageable level of a few hundred Mbyte/s.

- **Controls:** TDAQ and detector online control includes the capability to configure, operate and control the experiment (detector infrastructure, TDAQ) during data-taking, in testing and calibration runs and also to control certain vital service systems which remain active in periods when most of the detector and the LHC are shut down.
- **Monitoring:** online monitoring includes the capability to monitor the state and behaviour (operational monitoring), and the performance (detector and physics monitoring) of all parts of ATLAS both during physics data-taking and when calibration and testing operations are in progress.

## 5.2.2 HLT/DAQ building blocks

The HLT/DAQ system is designed to provide the above functions using the following building blocks:

- **ROD crate DAQ.** This is the building block which provides the data acquisition functions for a ROD crate. During detector commissioning, debugging or testing it allows data-taking to be performed on a single ROD crate. It is itself built from the building blocks described in the following paragraphs and is thus an integral part of the overall DAQ system, i.e. during normal experiment operations ROD crate DAQ is operated as an integral part of the overall DAQ.
- **Readout.** The Readout is a building block associated to functions of detector readout and the movement of event data. It provides for the receiving and buffering of event fragments coming from the RODs. The depth of the required buffers is determined by the duration of the LVL2 processing, plus the duration of event building (for events accepted by LVL2) and the time taken to remove the events from the system. In addition, the Readout provides a sub-set of the buffered event fragments to the LVL2 trigger and all event fragments to the event building.

It also provides the first stage in the HLT/DAQ where event fragments from more than a single ROD can be coherently sampled (with respect to the ELTID) for the provision of Monitoring functionality.

- **LVL2 processing.** As outlined in Chapter 1, the LVL2 trigger uses the RoI mechanism [5-1] to selectively read out only the parts of each event that it needs to make the selection. Starting from RoI information supplied by the LVL1 trigger, appropriate event fragments are requested from the Readout and used to decide on the acceptance or rejection of the event. Event fragments are requested on the basis of the LVL1 event identifier and the  $\eta$ - $\phi$  region. The selection proceeds in several steps (with several matching data requests) and an event is rejected if at any given step none of the algorithmic criteria for all available signatures are fulfilled.

- **RoI Collection:** This is the building block which, in conjunction with the Readout, provides the movement of a sub-set of event data to the LVL2 processing. It maps the  $\eta$ - $\phi$  region into Readout identifiers, collects the event fragments from the Readout and provides the LVL2 processing with the resulting single data structure representing the RoI data.

1. An event is removed from the ROS if it is rejected by the LVL2 and then following the completion of the event building process for those events which were accepted by the LVL2.
2. It is also foreseen that the quantity of event fragments sent to the event building may depend on the type of event.

- **Event Builder:** This building block provides, for those events passing the LVL2 processing selection criteria, for the movement of the event fragments out of the ROS. It builds, buffers, and formats a complete event as a single data structure. Following the building operation, the EB subsequently provides the event to the Event Filter.

It is also the first stage in the HLT/DAQ where complete event fragments may be sampled for the provision of Monitoring functionality.

- **Event Filter:** This final level of event rate and data volume reduction. With the LVL2 processing it provides the event selection functionality described in Section 5.2.1. It executes complex selection algorithms on complete events which are provided to it by the Event Building. It also provides an additional point in the HLT/DAQ where complete events may be used for the purposes of monitoring.

- **Controls:** This is the building block that provides the configuration, control and monitoring of the ATLAS experiment for and during the process of data taking. In conjunction with the Detector control and monitoring (see below) it provides the control functionality.

- **Detector control and monitoring:** The detector is brought to and maintained in an operational state by this building block. It also performs the monitoring of the state of the detector using the information provided by detector sensors, e.g. flow meters and temperature monitors. In addition it receives and monitors information provided to ATLAS by external systems, e.g. the LHC machine, CERN technical infrastructure.

- **Information services:** This building block provides for the exchange of information between the Controls building block and all other building blocks for the purposes of configuration, control and monitoring. It provides information management, error handling and with making available event fragments, sampled by the Readout and Event Builder, for the purpose of event-data-based operational monitoring of the detector.

- **Data bases:** Similarly to the Information services this is a building block that supports the Controls and Detector control and monitoring building blocks with respect to providing the functionality of configuration. It provides for the experiment's configuration description and its access by all building blocks. In addition, it allows the recording and accessing of information pertaining to the experiment's operation during data-taking.

## 5.2.3 HLT/DAQ interfaces

The HLT/DAQ system interfaces to a variety of other subsystems inside ATLAS, as well as external systems which are not under the experiment's control. The following sub-sections describe these interfaces with particular reference to the systems being connected, the interface responsibilities and the data exchanged across the interface. References to more detailed documentation on the interfaces, including data formats are also given.

The interfaces can be split into two classes, those to other systems in ATLAS, and those to external systems. Table 5-1 summarizes the characteristics of the former.

**Table 5-1** Overview of interfaces between HL/TDAQ and other ATLAS systems

Interface	Data Rate	Data Volume	Data Type
LVL1-LVL2	100 KHz	~1 kbyte/event	RoI Information
Detector specific non-physics trigger	few KHz	few words	Trigger signals
LVL1 & Detector Front-ends	100 KHz	~150 Gbyte/s	Raw data
Detector Monitoring interface	few Hz	few Mbyte/s	Raw, processed and control data
TDAQ - detectors			
Conditions Database	Intermittent	~100 Mbyte/run	System status
Mass Storage Interface	~200 Hz	~300 Mbyte/s	Raw data + LVL2 and EF results

### 5.2.3.1 Interfaces to other parts of ATLAS

#### 5.2.3.1.1 LVL1-LVL2 trigger interface

Although part of the TDAQ system, the LVL1 trigger is an external subsystem from the point of view of the DAQ and the HLT components.

A direct interface from the LVL1 trigger is provided through the ROIB which receives data from all of the LVL1 subsystems, the Calorimeter trigger, the Muon trigger and the CTP for events retained by LVL1. This information is combined on a per-event basis inside the ROIB, at the LVL1 rate, and passed to the supervisor of the LVL2 system, the L2SV. The interface has to run at full LVL1 speed, i.e. up to 100 KHz. The detailed specification of the LVL1-LVL2 interface is described in Ref. [5-2].

As mentioned above, there are RODs associated with the LVL1 trigger that receive detailed information on the LVL1 processing, e.g. intermediate results, for the events that are selected. The data from the corresponding ROBs are included in the event that is built following a LVL2-accept decision and is therefore accessible for the Event Filter processing. They could also be accessed earlier by the LVL2 trigger.

Trigger control signals generated by the LVL1 trigger are interfaced to the rest of the TDAQ system, as well as the detector readout systems, by the TTC system which is documented in detail in [5-1].

#### 5.2.3.1.2 Detector specific triggers

For test beams, during integration, installation and commissioning, and also for calibration runs, it will be necessary to trigger the DAQ for a sub-set of the full system, i.e. a partition, independent of the LVL1 CTP and LVL2, in parallel with other ongoing activities. Detectors are provided with Local Trigger processors (LTP) [5-3] which offer the necessary common functions for such running independently of the LVL1 CTP. Triggers provided independently of the CTP are

referred to as detector-specific triggers. A DFM is needed for each partition to initiate the building of partial events in that partition.

Any detector-specific trigger will communicate via the TTC system with its corresponding DFM. The DFM component therefore requires a TTC input and a mode where it will work independently from LVL2. A back-pressure mechanism throtles the detector specific trigger via the ROD-busy tree.

#### 5.2.3.1.3 Interface to the detector front-ends

The detector front-end systems provide the raw data for each event that LVL1 accepts. The detector side of the interface is the ROD, while the TDAQ side is the ROB. The connection between the two is the RoI.

From the point of view of the detector, i.e. ROD, the interface follows the S-LINK specification [5-4]. Implementation details of the RoI can change as long as this specification is followed. All RODs support a standard mezzanine card to hold the actual interface, either directly or on a rear-transition module. Data flow from the RODs to the ROBs, while only the link flow control is available in the reverse direction.

This interface has to work at the maximum possible LVL1 accept rate, i.e. up to 100 KHz and at 160 MByte/s.

#### 5.2.3.1.4 TDAQ access to the Conditions Databases

The conditions databases are expected to come from an LHC Computing Grid applications area project, with any ATLAS-specific implementation supported by the Offline Software group. The Online Software system will provide interfaces to the conditions databases for all TDAQ systems and detector applications which require them online. It remains to be studied how accessing the conditions database will affect the HLT performance itself and how frequently such access will need to occur. This is an area that will be addressed in more detail in the offline computing TDR which is currently planned to be published in 2005.

The conditions database will store all time-varying information of the ATLAS detector that is required both for reconstructing and analysing the data offline and for analysing and monitoring the time variation of detector parameters and performance. Components of the HLT/DAQ system will write information into the database and read from it. In most cases read access will occur at configuration time, but the HLT may need to access the database more often.

#### 5.2.3.1.5 Mass Storage

Events that have passed the EF will be written to mass storage. The design and support of the mass storage service will be centrally provided at CERN. However, in the first step of data storage, the Sub Farm Output (SFO) component will stream data directly to files on local disks. These will be large enough to accommodate typically a day of autonomous ATLAS data-taking in the event of failures in the network connecting ATLAS to the CERN mass storage system, or possible failures in the offline prompt reconstruction system. The event-data files are stored in a standard format (see [5-5] and [5-6]) and libraries are provided to read these files in offline applications. In normal running, data will be continuously sent from the local disk storage to the CERN mass storage system.

5.2.3.2 External interfaces

5.2.3.2.1 Interface to the LHC machine, safety systems and the CERN technical infrastructure

All communications between: the LHC machine; the general safety systems; the CERN technical infrastructure; the detector safety system; the magnets and the TDAQ are done via DCS, with the exception of fast signals (such as the LHC 40 MHz clock and orbit signal) that are handled in the LVL1 trigger. These communication mechanisms and interfaces are described in Chapter 11.

5.3 Architecture of the HLT/DAQ system

This section presents the global architecture of the ATLAS HLT/DAQ system. The architecture builds upon the work presented in previous documents that we have submitted to the LHCC: the ATLAS Technical Proposal [5-7], the DAQ, EF, LVL2 and DCS Technical Progress Report [5-8] and the HLT/DAQ/DCS Technical Proposal (TP) [5-9], and further developed by the requirements and performance studies, design, and development of prototypes and their exploitation in test beams, which has been done since the TP. Table 5-2 summarizes the performance required from the different TDAQ system functions.

Table 5-2 Required system performance capabilities for 100 kHz LVL1 accept rate

Function	Input requirements	Output requirements
Detector readout	~1600 event fragments of size typically 1 Kbyte at 100 kHz	Few per cent of input event fragments to LVL2 at 100 kHz; ~1600 event fragments at a few kHz to EB
Level-2	Few per cent of event fragments at 100 kHz	100 kHz decision rate (~3 kHz accept rate)
Event Builder	~1600 event fragments at ~3 kHz	~3 kHz and ~4.5 Gbyte/s
Event Filter	~3 kHz and ~4.5 Gbyte/s	~200 Hz and ~300 Mbyte/s

The numbers presented in this table are based on a 100 kHz LVL1 accept rate (we recall that the ATLAS baseline assumes a LVL1 accept rate of 75 kHz, upgradeable to 100 kHz), and therefore represent an upper limit in the required design and performance capabilities of the system. Detailed simulations of the LVL1 trigger (see Section 13.5) show that its accept rate at LHC start-up luminosity ( $2 \times 10^{33} \text{ cm}^{-2} \text{ s}^{-1}$ ) will be ~25 kHz. Simulation of the HLT at this luminosity indicate a LVL2 rejection factor of ~30. This rejection has been linearly extrapolated to 100 kHz to give the numbers in the table. This is probably a pessimistic assumption (see SECTION 14.2). The rate at the output of the EF is, however, quoted as that expected from the above simulations. The output capacity of the EF could be increased, but will be limited finally by offline data processing and storage capabilities

The architecture is presented following the functional breakdown given in the previous sections. The architectural components are described from the functional point of view, without reference to possible implementations at this stage. The baseline implementation of this architecture is presented in Section 5.5.

5.3.1 Architectural components

Figure 5-2 depicts the architectural components defined in the following text.

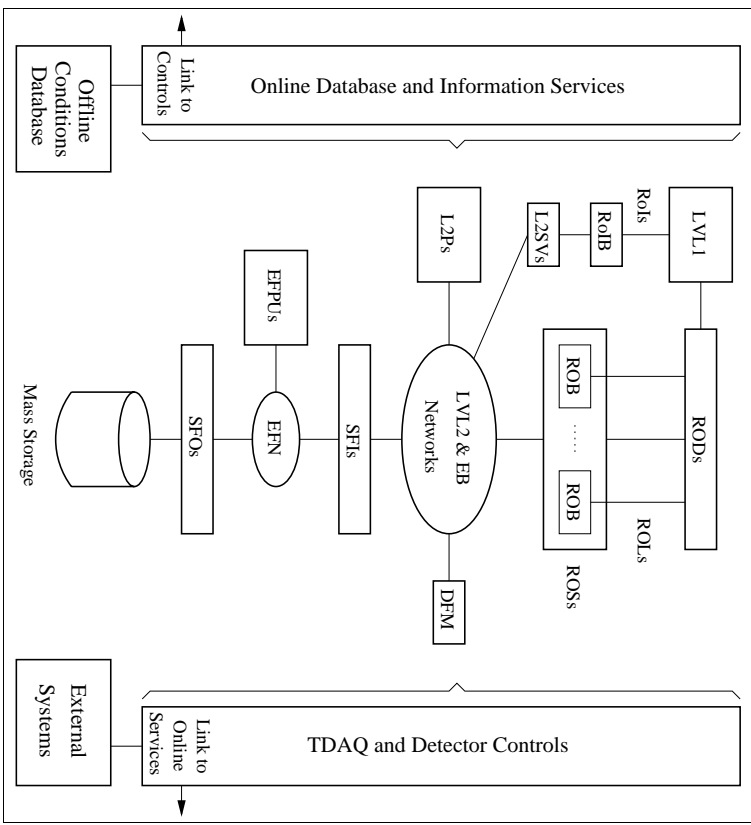

Figure 5-2 General architectural components and their relations

5.3.1.1 Detector readout

The communication link from the detector readout units (RODs), to the ROBs is the ROL. Each ROL carries one ROD fragment per event. The ROL must be able to transport data at a rate equal to the average event fragment size times the maximum LVL1 rate (possibly up to 160 Mbyte/s) — in the calculation, the average event fragment size should be taken as the average over LVL1 triggers for the ROD that sees the largest event fragments on average.

ROBs are the memory buffers located at the receiving end of the ROLs, there being one ROL associated to one ROB. Several (typically two or four) ROBs are physically implemented on a ROBIN card and several ROBins can be located in a ROS — the number depending on the implementation option (see Section 5.5.4). The ROS and its component ROBs provide two functions: buffering event data and serving requests for event data from the HLT.

The ROBins are of a unique design used by all the ATLAS sub-detectors<sup>1</sup>. The detector event fragments are sent from the RODs and stored in the ROBs. The ROBs buffer the event fragment for the time needed by LVL2 to reject or select the event, plus that needed by the EB to build selected events.

The ROS is the component for serving data from the ROBs to LVL2 and the EB. In order to reduce the number of connections into the LVL2 and EB networks it funnels a number of ROBs into a single port for each network. This ROB multiplexing capability is known as the ROB-ROS merging (RRM) function. The ROS also includes a software local controller of the online software (see Section 10.5), for the purpose of controlling data taking and local monitoring.

### 5.3.1.2 LVL2

The LVL2 trigger uses Rol information, provided by LVL1 via the RoIB, to request relevant event fragments from the ROS's (at the granularity of individual ROB's). Using these data, it produces a decision on the event and delivers the decision together with data it produced during its algorithmic processing back to the Data Flow components.

The RoIB receives information from LVL1 following each LVL1 trigger, allocates a LVL2 Supervisor (L2SV - see below) for the event, and transmits aggregate LVL1 information, after formatting, to the allocated supervisor. The RoIB will run at the rate of the LVL1 trigger. The L2SV then assigns, according to a load-balancing algorithm, a LVL2 Processor (L2P) from a pool under its control to process the event, and forwards the LVL1 information provided by the RoIB to an event handling process, the LVL2 processing unit (L2PU), running on the L2P. The L2PU, using this LVL1 information, requests event fragments from the ROS, processes the Rol data, and makes a decision to accept or reject the event. In the course of processing the event data, additional requests for event fragments may be issued in several steps. The L2PU may, according to a pre-defined algorithm, decide to flag for accept, events which have in fact been rejected by the algorithm processing. This would be done in order to monitor the LVL2 selection process either in the EF or offline. The L2PU may also effect any required prescaling of selected channels. The final accept/reject decision is sent back to the L2SV. If an event is rejected, the decision is passed to the ROS via the DFM in order to remove the event from the ROB's. If an event is accepted, the decision is forwarded to the DFM, which then initiates the event building operation for the event.

A switching network, the L2N (LVL2 Network) component, links the ROS's, the L2SV and the L2P's. The L2P's will be organized into sub-farms in a manner which optimizes the use of the L2N.

Online software local controllers are associated to the RoIB, the L2SV's and L2P sub-farms, for the purpose of controlling and monitoring the LVL2 trigger.

1. Contrary to the ROD, which is a specialised detector-specific module, there is a single ROBIn implementation for the whole experiment. RODs for the different detectors implement detector-dependent functions. For example, digital signal processing is implemented in the case of the LAr sub-detector.
2. The L2SV may also assign a given L2P on the basis of the LVL1 trigger type.

### 5.3.1.3 Event Builder

Events accepted by LVL2 are fully assembled and formatted in the EB's destination nodes, the SFI's. The DFM component is informed by the L2SV of the LVL2 decision. For each accepted event, the DFM, according to a load-balancing algorithm and other selective allocation considerations (e.g. special triggers and monitoring - see below), allocates an SFI. For rejected events and for events which have been successfully built, the DFM initiates a procedure to clear these events from the ROS's.

When the LVL2 system is not in use, for example during a detector calibration run, the DFM provides a LVL2-bypass mechanism. It is informed when new events are available for building, directly by the LVL1 CTP system or the Local Trigger Processor (see Section 5.2.3.1.2) of the detector being calibrated, via the TTC network. In the event of several TDAQ partitions being run in parallel, each running partition has a dedicated DFM for initiating event building within that partition.

The DFM has the additional capability to assign SFIs on the basis of pre-defined criteria, e.g. forced-accepted LVL2 events, special LVL1/LVL2 trigger types (as defined by the detector systems) etc.

The SFI allocated by the DFM requests and receives event data from the ROS's, builds and formats the event in its memory. It notifies the DFM when a complete event has been built, correctly or otherwise, e.g. when expected event fragments are missing. In the latter case, the SFI attempts corrective action, by trying to re-access the missing fragments. Built events are buffered in the SFIs in order to be served to the EF. For efficiency reasons, the SFI can build more than one event in parallel.

A switching network, the EBN (Event Builder Network) component<sup>1</sup>, links ROS's, SFIs and the DFM. The network enables the building of events concurrently into all the SFIs at an overall rate of a few kHz.

Online software local controllers are associated to the DFM and SFIs for the purpose of controlling and monitoring the event building.

### 5.3.1.4 Event Filter

The EF comprises a large farm of processors, the EFPUs. Each EFPU deals with complete events served by the SFIs, as opposed to the selected event data used by the LVL2 trigger. From the architectural point of view the EF is a general computing tool for analysis of complete events — either events produced by the full ATLAS detector or the set of event data associated to a detector partition. Indeed, it is also envisaged to use all or part of the EF for offline computing purposes, outside of ATLAS data taking periods.

Each EFPU runs an EF data flow control program (EFD) which receives built events from the SFIs. Several independent Processing Tasks (PTs) continuously process events which are allocated to them on demand by the EFD. Using offline-like event reconstruction and selection algorithms, the PT processes the event and produces a final trigger decision. When a given PT has

1. The logically separate LVL2 and EB networks (which fulfil two different functions) could be implemented on a single physical network; in particular, this might be the case in the early phase of the experiment when the full performance is not required.



completed processing an event, it requests a new one to be transferred from an SFI via the EPD. Data generated by the PTs during processing are appended to the complete raw event, if accepted, by the EPD. Accepted events are classified and moved to respective Sub-Farm Output buffers (SFOs) where they are written into local disk files. Completed files are accessed by a mass storage system for permanent storage (Section 5.2.3.1.5). Note that EPDs may send events to one of several parallel SFO output streams for further dedicated analysis, e.g. express analysis, calibration, debugging.

The EFPUs are organized in terms of clusters or sub-farms, with each sub-farm being associated to one or more SFI and SFO. The minimum granularity of EFPUs as seen from partitions is the sub-farm. SFIs, SFOs and EFPUs are interconnected via a switching network, the EFN (EF Network) component.

The EF sub-farms may also be used for purposes other than event triggering and classification. A sub-farm may be allocated to running detector calibration and monitoring procedures which require events possessing specific characteristics. As discussed above, the DFM can assign events to dedicated SFIs from which EF sub-farms can request those events for dedicated analyses.

Monitoring and control of the EF itself is performed by a number of local controllers which interface to the online system.

### 5.3.1.5 Online software system

The Online Software system encompasses the software to configure, control and monitor the TDAQ system (known as the TDAQ control system), but excludes the management, processing and transportation of physics data. Examples of the online software services are: local control processes which interface to other TDAQ components, as noted above, general process management, run control, configuration data storage and access, monitoring and histogramming facilities. A number of services are also provided to support the various types of information exchange between TDAQ software applications. Information can be shared between applications in the same sub-system, across different sub-systems, and between TDAQ systems and detectors.

TDAQ and detectors use the configuration databases to store the parameters and dependencies which describe their system topology and the parameters which are used for data-taking. The offline conditions databases are used to read and to store data which reflect the conditions under which the event data were taken.

The software infrastructure integrates the online services with the rest of TDAQ into a coherent software system. The hardware infrastructure comprises the Online Software Farm (OSF), the computers on which the services run, and an Online Software switching network (OSN) which interconnects the OSF with other TDAQ components including the DCS for control and information exchange as well as detector components which require access to online software facilities. The OSF will include machines dedicated to monitoring event data and database servers which hold the software and firmware for all of the TDAQ system — there will be servers local to clusters of computers which perform a common function, as well as central, backup servers.

Online software, services and infrastructure, are described in detail in Chapter 10.

### 5.3.1.6 Detector Control System

The DCS has a high degree of independence from the rest of the HLT/DAQ system, being required to be able to run at all times, even if HLT/DAQ is not available. At the level of detail suitable for this chapter, the DCS is a single component, without internal structure. It is interfaced to the rest of the system via the Online Software system. The interplay between DCS and TDAQ control is discussed in Section 5.3.2.

DCS is the only ATLAS interface with the LHC machine, with the exception of that for fast signals (which is handled directly by the LV1 system). A detailed definition and description of the DCS architecture, interfaces and implementation is given in Chapter 11.

### 5.3.2 Overall experimental control

The overall control of ATLAS includes the monitoring and control of the operational parameters of the detector and of the experiment infrastructure, as well as the supervision of all processes involved in the event readout and selection. This control function is provided by a complementary and coherent interaction between the TDAQ control system and the DCS. Whilst the TDAQ control is only required when taking data or during calibration and testing periods, the DCS has to operate continuously to ensure the safe operation of the detector, and a reliable coordination with the LHC control system and essential external services. DCS control services are therefore available for the sub-detectors at all times. The TDAQ control has the overall control during data-taking operations.

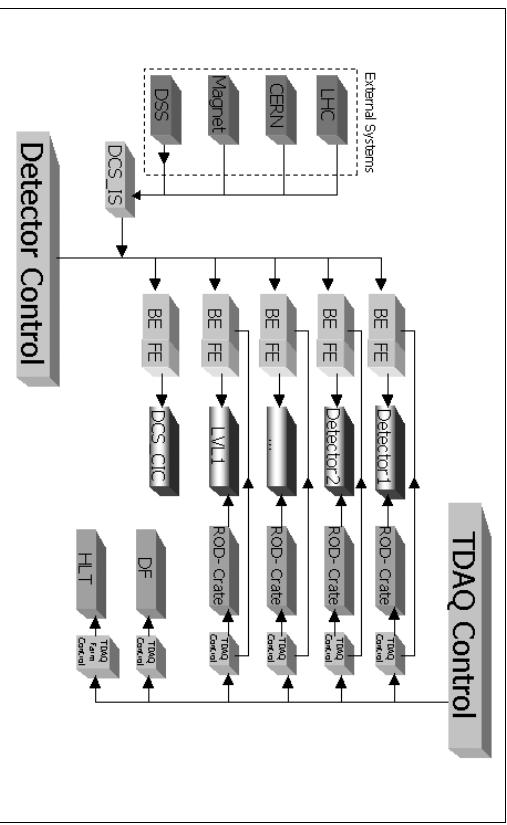

Figure 5-3 Logical experiment controls flow

There is a two-way exchange of information between DCS and the TDAQ control via mechanisms defined and provided by the Online Software (see Chapter 10). DCS will report informa-

tion about the status and readiness of various components which it controls and monitors to the Online system. The Online system will provide both configuration information and issue commands related to run control to DCS. Figure 5-3 presents the logical experiment control flow. In the figure, the lines represent the bi-directional information exchange between the systems, while the arrows on the lines indicate the direction of the command flow. The TDAQ control and DCS actions are coordinated at the sub-detector level. Each sub-detector, as well as the HLT and Data Flow systems, has TDAQ control elements responsible for the data-taking control. DCS control elements, called the Back-End (BE), control the sub-detector Front-End (FE) and LV1 trigger equipment. DCS also controls the hardware infrastructure which is common to all the detectors, the DCS-Common Infrastructure Controls (DCS-CIC). The interaction with the LHC machine, which is explained in Chapter 11, and other external services is handled by DCS via the Information Service (DCS-IS). Experiment control is addressed in more detail in Chapter 12.

## 5.4 Partitioning

As already discussed in Chapter 3, partitioning refers to the capability of providing the functionality of the complete TDAQ to a sub-set of the ATLAS detector. For example, the ability to read out all or part of a specific detector with a dedicated local trigger in one partition, while the other detectors are data-taking in one or more independent partitions.

The definition of the detector sub-set defines which ROBs belong to the partition (because of the connectivity between RODs and ROBs, and the fact that RODs are grouped into TTC partitions). For example, if a partition of the muon MDT chambers is required, the ROBs associated to the MDT RODs will be contained in the partition. Downstream of the ROBs a partition is realised by assigning part of TDAQ (EBN, SFL, EF, OSF and networking) to the partition — this is a resource-management issue. Some examples of TDAQ components which may have to be assigned to a TDAQ partition are: a sub-set of the ROBs, as mentioned above, and a sub-set of the SFLs. The precise resource allocation in a particular case will depend on what the partition is required to do. For example, in order to calibrate an entire detector, all that detector's allocated ROBs, a fraction of the event building bandwidth and several EF sub-farms as well as online software control and monitoring functions may be required.

As regards the transport of the data to the allocated resources, the DFM allocates SFLs responsible for event building from a sub-set of ROSS. In order for this to happen, in the case of partitions associated to non-physics runs (i.e. when there is no IVL2) but which require functionality beyond the ROS, the DFM must receive, via the TTC, the triggering information for the relevant partition. Hence the need for full connectivity between the DFMs and the TTC partitions.

## 5.5 Implementation of the architecture

### 5.5.1 Overview

This section defines a concrete implementation for each of the architectural components described in the previous sections. The choices for what we call the baseline implementation have been guided by the following criteria:

- The existence of working prototypes.
- Performance measurements which either fulfil the final ATLAS specifications today or can be safely extrapolated to the required performance on the relevant timescale (e.g. extrapolating CPU speed of PCs according to Moore's law).
- The availability of a clear evolution and staging path from a small initial system for use in test beams, to the full ATLAS system for high-luminosity running.
- The overall cost-effectiveness of the implementation and the existence of a cost-effective staging scenario.
- The possibility to take advantage of future technological changes over the lifetime of the experiment.

The proposed baseline implementation is a system that could be built with today's technology and achieves the desired performance. It is expected that technological advances in the areas of networking and computing will continue with the current pace over the next few years; these will simplify various aspects of the proposed architecture and its implementation. Optimization in the area of the ROB I/O (see Section 5.5.4) remains to be performed prior to freezing details of the implementation.

By making use of commercial off-the-shelf (COTS) components based on widely-supported industrial standards wherever possible, the architecture will be able to take advantage of any future improvements from industry in a straightforward way. Only four custom components are foreseen in the final HIT/DAQ/DCS system as such<sup>1</sup>: the DCS ELMB module; the ROB, of which only a single instance is needed; the ROL implementation; and the ROBin, which implements the ROL destination and the ROB functionality. Components of the TTC system are also custom elements but are common across the entire experiment (and indeed used in other LHC experiments).

The component performance and overall system performance figures which help to justify the proposed implementation can be found in Part 3 of this document.

Figure 5-4 depicts the baseline implementation of the system. The Online Software system is implicitly understood to be connected to all elements in the figure, and the DCS to all hardware elements which need to be monitored and controlled. Table 5-3 lists the principal assumptions from which the size of the implementation has been determined. Table 5-4 presents more details on the estimated size of the system; it lists the components that make up the baseline implementation and, for each one, gives the number of units and the associated technology.

<sup>1</sup> The ROL source cards and the ELMB (see Chapter 11) are custom components which are specified and produced under the responsibility of the TDAQ project. However, these are integrated in the detector systems.

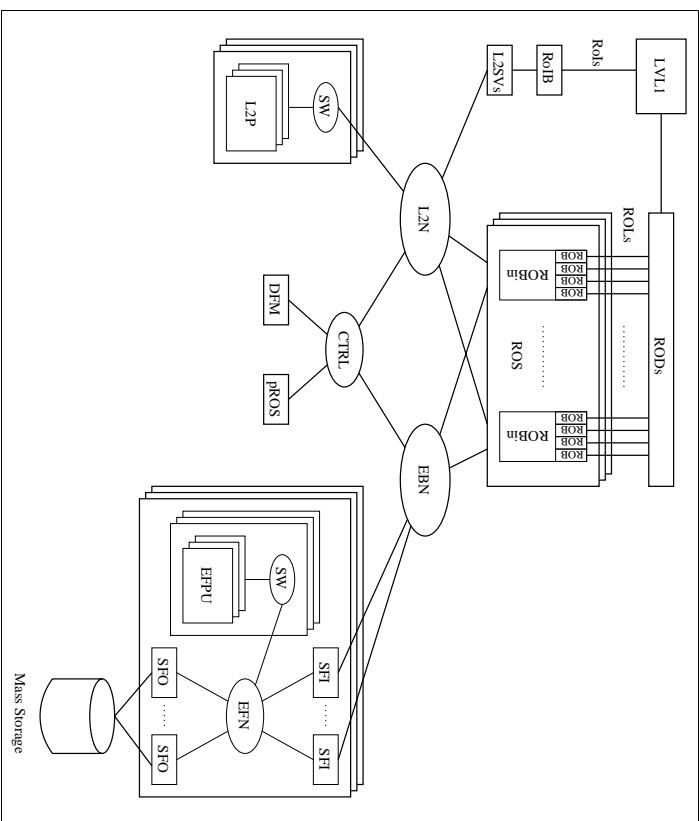

Figure 5-4 Baseline implementation of the Data Flow and High-Level Trigger

Table 5-3 Assumptions

Parameter	Assumed value	Comments
LVL1 rate	100 kHz	HIT/DAQ designed at this LVL1 rate
Event size (maximum)	2 Mbyte	Assumes maximum fragment size for all sub-detectors during normal high-luminosity running
Event size (average)	1.5 Mbyte	Assumed average value
LVL2 rejection	~30	EB rate of 3.3 kHz
Roi data volume	2% of total event size	Detector data within an Roi - average value
L2P rate (events/second)	~100	LVL2 decisions/sec/processor Assume dual-CPU (8 GHz) machines
EFPU rate (events/second)	~1	EF decisions/sec/processor Assumed dual-CPU (8 GHz) machines

Table 5-4 Baseline implementation and size at 100 kHz Level-1 rate

Component	Number of elements	Technology	Comments
ROL	~1600 Links	Custom	Follows S-Link specification.
ROBin	~400 ROBins	Custom module	One ROBin multiplexes and buffers data from 4 ROLs.
ROS <sup>a</sup>	~60 switches ~60 PCs	Gigabit Ethernet Industrial PC	10/(ROBin)x4(uplinks) concentrating factor: PC houses ~10 ROLs. ROBins are addressed individually via the concentrator switch.
ROS <sup>a</sup>	~150 PCs	Industrial PC	Multiplexes 3 ROBins. Relays Roi requests to appropriate ROBin. Builds super-fragment for the Event Builder.
LVL2 Network	~650 ports <sup>b</sup>	Gigabit Ethernet	Connects ROS, L2P, L2SV, DFM.
EB Network	~250 ports	Gigabit Ethernet	Connects ROS, SFI, DFM.
ROiB	1 unit	Custom Module	
L2SV	~10	Dual-CPU PC <sup>c</sup>	One L2SV every 10 kHz of Level-1 trigger rate.
DFM	~35	Dual-CPU PC <sup>c</sup>	One per TTC partition.
L2P	~500	Dual-CPU PC <sup>c</sup>	Run LVL2 selection algorithms.
SFI	~90	Dual-CPU PC <sup>c,d</sup>	Build (and buffer) complete events.
EFPU	~1600	Dual-CPU PC <sup>c</sup>	Run EF selection algorithms.
EF Network	~1700 ports	Gigabit Ethernet	Connects SFI, EFPU and SFO.
SFO	~30	Dual-CPU PC <sup>c</sup> and ~1Tbyte disk storage	Buffers events accepted by EF and stores them on permanent storage.
File Servers	~100	Dual-CPU PC <sup>c</sup> with ~1Tbyte of disk space	Holds copy of databases and software. Local to a group of functionally homogeneous elements (e.g. a group of EFP).
Data base servers	~2	RAID based file server	Hold master copy of databases, initialisation data and down-loadable software.
Online farm	~50	Standard PCs	Operate and monitor the experiment. Runs online services.
Local control switch	~100	Gigabit Ethernet	Connects a group of ~30 elements (e.g. a LVL2 sub-farm) to the central control switch.
Central control switch	250 ports	Gigabit Ethernet	Connects online farm, local control switches, and other system elements.

a. The ROS row indicates the number of components for both the switch-based (top numbers in the row) and bus-based ROS (bottom numbers).  
 b. The size of connectivity for the Level-2 network. The actual size of the central switch will be greatly reduced by the use of small concentrator switches (e.g. 5 L2Ps into a single central switch port).  
 c. Assume 8 GHz CPU clock rate.  
 d. At 8 GHz clock speed, the SFI may only require a single-CPU PC.

## 5.5.2 Categories of components

The implementation calls for the use of a small number of categories of components, which are either custom or commercial, as follows:

- **Buffers:** These are used to decouple the different parts of the system: detector readout, LVL2, EB and EF. Because of the parallelism designed into the system, buffers fulfilling the same function, e.g. ROBns, operate concurrently and independently.
- **Processors:** These run event selection algorithms, monitor and control the system. They are typically organized in farms, i.e. groups of processors performing the same function.
- **Supervisors:** These are generally processors dedicated to coordinating concurrent activities, in terms of assigning events to processors and buffers at the different levels: the LVL2 trigger (supervised by the ROB and LZSV units), the EB (supervised by the DEM) and the EF (supervised internally by its data flow control).
- **Communication systems:** These connect buffers and processors to provide a path for transporting event data or a path to control and operate the overall system. Communication systems are present at different locations in the system. Some of them provide a multiplexing function, i.e. they concentrate a number of input links into a smaller number of output links. Depending on how the architecture is physically realised, a multiplexer may have a physical implementation (e.g. a switch, or a bus) or not (viz. a one-to-one connection, without multiplexing).

## 5.5.3 Custom Components

### 5.5.3.1 The ELMB

The Embedded Local Monitor Board designed for use by the DCS system (see Chapter 11).

### 5.5.3.2 The Read Out Link

The ROL will be implemented based on the S-LINK protocol [5-4]. It is discussed in detail in Section 8.1.2. The RODs will host the link source cards, either as mezzanines mounted directly on the RODs or on rear-transition modules. The ROBns, located near the RODs in USA15, will host several link destination cards. About 1600 links will be needed.

### 5.5.3.3 The ROBIN

The ROBIN is implemented as a PCI board receiving data from a number of ROLs. Each ROBIN has a PCI interface and a Gigabit Ethernet output interface [5-10]. The high-speed input data paths from the RODs are handled by an FPGA. The buffers associated to each input ROL will be big enough to deal with the system latency (LVL2 decision time, time to receive the clear command after a LVL2 reject and time to build the complete event following a LVL2 accept). A PowerPC CPU is available on each ROBIN. The prototype ROBIN is currently implemented on a single PCI board implementing two input links. The final ROBIN design is expected to support four ROL channels.

## 5.5.3.4 The Region-of-Interest Builder

The ROB design is modular and scalable and is custom designed and built. It is described in detail in [5-11]. The link interface from LVL1 to the ROB follows the S-LINK specification. There are inputs from eight different sources to the ROB (Section 5.2.3.1.1). Data flow from the LVL1 system to the ROB, with the link interface providing only flow control in the reverse direction. Asserting XOFF is the only way for the ROB to stop the trigger. The output of the ROB is sent via S-LINK (or possibly via Gigabit Ethernet) to one of the LZSV processors.

## 5.5.4 ReadOut System

The ROS is implemented as a rack-mounted PC. Each ROS contains several ROBns, and has connections to the LVL2 and EB networks. Each ROBIN multiplexes up to four ROLs into a single physical output channel. The ROS multiplexes the ROBIN outputs onto the central LVL2 and EB networks (the RRM function, see Section 5.3.1.1). The RRM multiplexing factor depends on the physical number of links between the ROS and each of the central networks. The maximum factor can be calculated from external parameters, in particular the average ROL size, the peak ROL fragment request rate per ROB, and the LVL2 rejection power:

The RRM function may be implemented in two different ways:

- The bus-based ROS — the ROS PC contains three ROBns, each connected to its own PCI-bus and each having four ROL inputs to four ROBns, and one PCI output. This output is connected to the ROS's PCI-buses, which implement the RRM function. Requests, coming from LVL2 or the EB, for event fragments in the ROB, are handled directly by the ROS PC which aggregates the event fragments over its PCI-buses before dispatching them to the LVL2 or the EB. Gigabit Ethernet interfaces connect the ROS to the LVL2 and EB networks.
- The switch-based ROS — the ROS PC houses typically 10 ROBns, each having four ROL inputs to four ROBns, and one Gigabit Ethernet output. The RRM function is implemented typically using a 10 x 4 Gigabit Ethernet switch, which concentrates the ROBIN outputs directly into four Gigabit Ethernet outputs: two for the LVL2 network and two for the EB network<sup>1</sup>. The switch-based ROS is understood to include the switch as well as the PC. The ROS PC itself does not play any role in the process of transferring data between the ROBns, and the LVL2 and EB. It is solely responsible via its PCI-bus for the physical housing of the ROBns, their initialisation and control, and some monitoring functions.

Bus-based and switch-based ROS's are depicted in Figure 5-5. Preliminary studies have already been made on both implementation options, details can be found in Refs. [5-12] and [5-13]. The current ROBIN prototype allows access to the ROB data via both the PCI-bus and the Gigabit Ethernet interfaces. The optimization of the ROS architecture, as indicated previously, will be the subject of post-TDR studies using this prototype. The final decision on an optimized design for the ROS architecture will be taken based on the results of these studies on a timescale compatible with the production of the ROBns (see Chapter 18).

As noted above, the ROBns, and therefore the ROSS will be located underground in the USA15 cavern.

1. Whether one, two or more outputs are used each, to the EB & LVL2 networks will depend on how many switches are used to implement these networks.

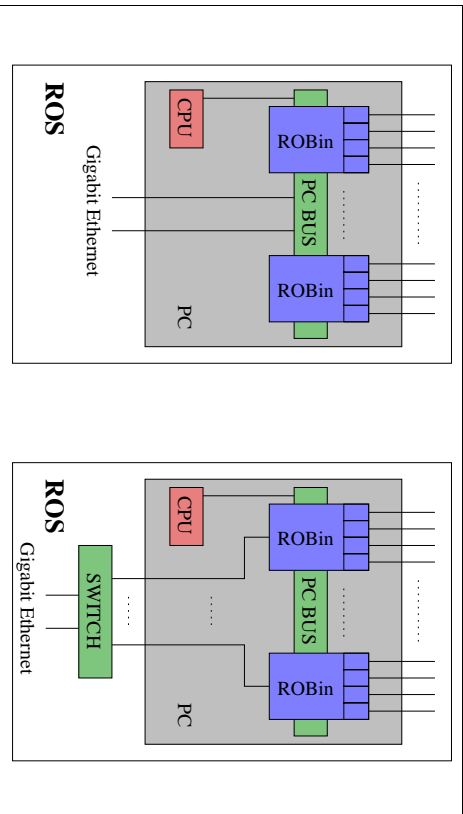

Figure 5-5 Bus and switched based ROSs

### 5.5.5 Networks

All networks use Gigabit Ethernet technology, despite the fact that in some cases, e.g. for the EFN, Fast Ethernet (100 Mbyte/s) would be sufficient to satisfy the requirements today. Considerations of overall network uniformity, technology evolution, and expected cost evolution justify this choice.

Following the first level of ROB concentration in the ROS (see Section 5.5.4), the topology of the EB and LVL2 networks consists of central switches, connecting sources (i.e. ROSs) and destinations (e.g. SFTs and L2Ps). These central networks will, logically, be monolithic in the sense that each network will connect to all of its sources and destinations. However, they may be physically organised either in terms of large monolithic switches or in terms of combined small switches. The detailed network topology will be fixed at the time of implementation.

Given the number of L2Ps (typically ~500 dual CPUs), small concentrating switches are used around the L2Ps to reduce the number of ports on the central switches. This is possible since the bandwidth per processor is much less than Gigabit Ethernet link capacity.

The organisation of the OSN, reflects the organization of the online farm. It is hierarchical, with networks local to specific functional elements (e.g. an EF sub-farm) and up-links to a central network providing the full connectivity. Typically, the OSN will be organized in terms of small (~40 ports) switches, local to groups of components with common functions (e.g. L2Ps), which connect through a large (~200 ports) central switch.

The current baseline for the overall EF network is a set of small independent networks, EFN, each connecting a set of EF nodes with a number of SFTs and SFOs. This scheme allows flexibility in choosing the number of EF nodes for each cluster. The input rate capability can be increased by simply adding more SFT nodes to a given sub-farm. The EF network is organized in two layers. The lower layer consists of EF nodes clustered via small switches (labelled 'SW' in

Figure 5-4, ~20 ports). The higher layer, connects together a number of these EF clusters to one or more SFTs and SFOs via an EFN switch.

One possible network architecture implementation and topology, using the switch-based ROS (see Section 5.5.4) as an example, is given in Ref. [5-13].

### 5.5.6 Supervisory Components

The LVSV and DFM supervisory components are implemented by high-performance rack mounted dual-CPU PCs running Linux, connected to the EB and LVL2 networks. A custom PCI-to-S-LINK interface or standard Gigabit Ethernet technology may be used to connect the L2SV to the RoIB, and standard Gigabit Ethernet technology to connect the L2SV to the rest of the system. The connection between the DFM and the TTC network has not been defined yet — it could be based, for example, on a network technology or on a dedicated PCI-to-TTC-receiver interface.

Measurements done so far show that at the nominal LVL1 rate (100 kHz), only a small number (~10) L2SVs are required. One DFM is required for each active concurrent TDAQ partition (see Section 5.4) — this includes the main data-taking partition. All DFMs except for the one running the main data-taking partition will need to receive detector specific triggers directly or indirectly from the relevant TTC partition. In the main partition, the DFM receives its input from the L2SVs. The maximum foreseen number of partitions in ATLAS is 35. In practise, the number of active concurrent TDAQ partitions which require a DFM and in use at any time is likely to be less than this. A back-pressure mechanism will throttle the detector specific trigger rate via the ROD-busy tree if it becomes unmanageable.

### 5.5.7 HLT processors

LVL2 and EF processors will be normal rack-mounted PCs running Linux. Dual-CPU systems are the most appropriate solution at the moment, although that may change in the future. We estimate that there will be ~500 LVL2 processors and ~1600 EF processors in the final (100 kHz) system (assuming 8 GHz clock speed), but initial setups during commissioning, and for the initial data-taking when the luminosity will be below the LHC design luminosity, will be much smaller. LVL2 and EF processors are COTS components and can be replaced or added at any time. Computing performance is more important than I/O capacity in the EF nodes.

Although IU servers currently offer an attractive implementation for the farms, blade servers, which house hundreds of processors in a rack together with local switches, have a number of potential advantages, e.g. lower power requirements, higher density, and may offer a more attractive solution of sufficient maturity by the time the farms are purchased.

Studies are currently underway (see [5-14]) to investigate the possibility and implications of siting some EF sub-farms at locations outside CERN (e.g. at ATLAS institutes or computing centres). This would have the advantage of being able to benefit from existing computing equipment, both during the initial phases of the experiment, when only a fraction of the EF equipment at CERN will have been purchased and throughout the lifetime of the experiment for non-critical applications such as data monitoring.

### 5.5.8 Event-Building processors

The SFI's are again rack-mounted PCs running Linux. The event building process requires a large CPU capacity to handle the I/O load and the event assembly. Again dual-CPU systems are the most cost-effective solution at the moment. The SFI components require no special hardware apart from a second Gigabit Ethernet interface that connects them to the EF network. Roughly 90 units are envisaged for the final system.

### 5.5.9 Mass storage

The SFOs write events to the disks in a series of files, and provide buffering if the network connection to the CERN mass storage system is down. Assuming that the SFOs have to buffer ~1 day of event data, with an average event size of 1.5 Mbyte per event at a rate of ~200 Hz, they will need a total of ~26 Tbyte of disk storage. Today, relatively cheap PC servers can be bought with > 1 Tbyte of IDE disk storage. The SFOs will therefore consist of normal PCs, with a housing that allows the addition of large disk arrays — approximately 30 units are assumed for the final system.

### 5.5.10 Online Farm

The online farm provides diverse functions related to control, monitoring, supervision and information/data services. It will be organized hierarchically in terms of controllers and database servers local to the TDAQ functional blocks (for example the ROS or an EF sub-farm) and clusters of processors providing global functions (experiment control, general information services, central database servers).

The processors for experiment control and general information services will be standard PCs organized in small farms of ~20 PCs each. Local file servers are also standard PCs, with the addition of a large local disk storage (~1 Tbyte) while the central data base servers are large file servers with several TByte of RAID disk storage.

At the time of system initialisation, quasi-simultaneous access to the configuration and conditions databases will be required by many hundreds of processes, in some cases requiring O(100) Mbyte data each. This calls for a high-performance in-memory database system and a structured organisation of the database servers to spread the I/O load sufficiently widely that the system can be initialized and configured in a reasonable time. It is proposed to organize the database infrastructure as follows:

- Local data servers: database servers that hold a copy of the conditions and configurations databases to be accessed locally by an homogeneous sub-set of the system (e.g. an EF sub-farm). A copy of specific software and miscellaneous data that is to be downloaded into the components in the sub-set is also held on the local server.
- Central server: a fault tolerant, redundant database server which holds the master copy of the TDAQ software and configuration as well as a copy of the conditions data. Local servers are updated from the central server at appropriate intervals. The central server may both update and be updated by the central offline conditions database.

The control of database write access and synchronization – in particular in the case of conditions data where both online and offline clients may wish to write to the database at the same

time – is a complex problem which has not yet been addressed in detail. This issue will be studied in common with the offline community as well as with other experiments with the aim of arriving at a common solution.

### 5.5.11 Deployment

Functionally homogeneous components, e.g. EF processors, are organized in terms of standard ATLAS sub-farm racks. Each rack contains, in addition to the computing components: a local file server; a local online switch (to connect all the components to the online central switch); a rack controller; and the necessary power and cooling distribution. We are investigating, with other LHC experiments, cooling systems for racks with horizontal air-flow suitable for rack-mounted PCs. The number of components per rack depends on the size of the racks. Table 5-5 summarizes the organization of the different racks, the number of racks of a specified content per function and their physical location.

Table 5-5 Rack organisation and location

Unit Type	Number of units	Composition	Location
ROS rack	~15	~15 ROSS Local online switch Local file server Rack controller	USA15 – underground
HLT Rack	~20 for Level-2 ~80 for Event Filter	~30 Processing Units Local online switch Local file server Rack controller	SDX 15 – surface 50% of EF racks possibly located in the CERN computer center
SFI rack	3-4	~30 SFIs/ rack Local online switch Local file server Rack controller	SDX 15 – surface
SFO rack	6-7	~5 SFO (+ Disk space) Local online switch Local file server Rack controller	SDX 15 – surface
Online rack	3	~20-30 Processors Local online switch Local file server Rack controller	SDX 15 – surface
Central switches	3	~256 ports per switch	SDX 15 – surface

### 5.6 Scalability and Staging

The performance profile anticipated for the ATLAS TDAQ system between the detector installation and the availability of the LHC nominal luminosity, is summarized in Table 5-6. It is expressed as the required LVLI rate in kHz.

**Table 5-6** TDAQ required performance profile

Phase	Date (TDAQ ready by)	Performance (LVL1 rate)
ATLAS Commissioning	2005	N/A <sup>a</sup>
Cosmic-ray run	2006	N/A <sup>a</sup>
ATLAS start-up	2007	37.5 KHz
Full performance	2008	75 KHz
Final performance	2009	100 KHz

a. Provide full detector read-out but minimal HLT capability.

The scalability of the TDAQ system is discussed on the basis of the above performance profile. Prior to the ATLAS start-up, the TDAQ system will provide the full detector read-out, for the purpose of commissioning the experiment and the cosmic run, and a minimal HLT system appropriate to fulfill the requirements for this period (few KHz).

The detector readout system must be fully available at the time of the detector commissioning (i.e. in 2005). Irrespective of the rate performance, since all parts of the detector must be connected. In contrast, the processing power in the HLT depends on the maximum LVL1 rate that must be accepted. Since the LVL2 and EF farms, as well as SFIs, SFOs, etc. are implemented using standard computer equipment connected by Gigabit Ethernet networks, they can be extended as financial resources become available.

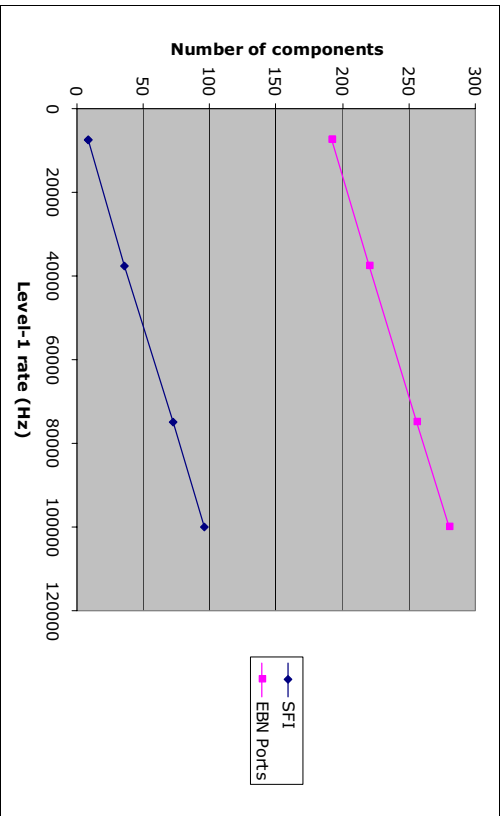
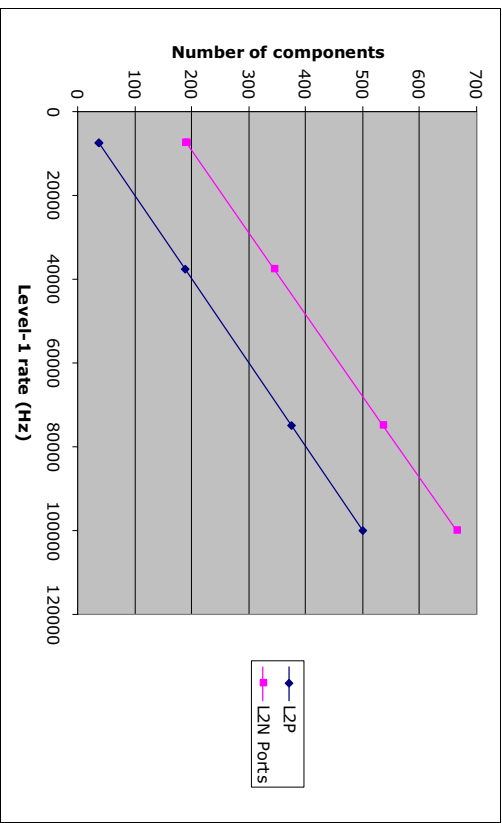

**Figure 5-6** Scaling of the Event Builder sub-system

1. Some 25% of the detector ROI.s, corresponding to the part of the ATLAS detector which is staged, will not be installed at the start-up of ATLAS but later: currently planned for 2008.

The strategy is therefore the staging of the farms and associated networks. In the latter case, additional central switches (if a topology based on multiple central switches will be chosen) or ports (for monolithic central switches) will be added to support the additional HLT nodes. The same argument, although on a smaller scale, applies to SFIs and SFOs.

The scaling of the TDAQ system size, as a function of the Level-1 trigger rate, is depicted in Figure 5-6 for the Event Builder (number of SFIs and number of EBN ports), Figure 5-7 for the Level-2 sub-system (number of L2Ps and number of L2N ports) and Figure 5-8 for the Event Filter (number of EFPs and ports of the Event Filter network).



**Figure 5-7** Level-2 system scaling

## 5.7 References

- 5-1 ATLAS First-Level Trigger Technical Design Report, CERN/LHCC/98-14 (1998)
- 5-2 Specification of the LVL1 / LVL2 trigger interface, ATLAS EDMS Note, ATL-D-ES-0003, <http://edm.cern.ch/document/107485/1/1>
- 5-3 Proposal for a Local Trigger Processor, ATLAS EDMS Note, ATL-DA-ES-0033, <http://edm.cern.ch/document/374560/1>
- 5-4 Recommendations of the Detector Interface Group - ROD Working Group, ATLAS EDMS Note, ATL-D-ES-0003, <http://edm.cern.ch/document/332389/1>
- 5-5 The raw event format in the ATLAS Trigger & DAQ, ATLAS Internal Note, ATL-DAQ-98-129 (1998)
- 5-6 Event Storage Requirements, ATLAS EDMS Note, ATL-DQ-ES-0041, <https://edm.cern.ch/document/391572/0/4>

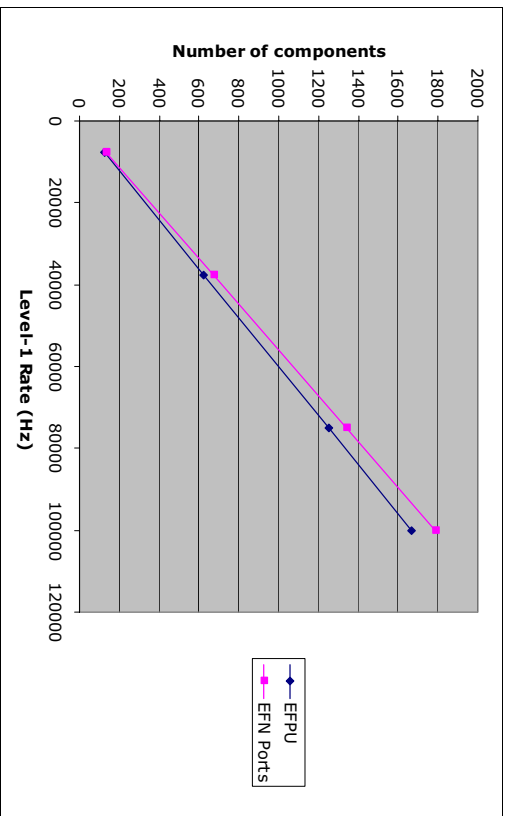

Figure 5-8 Event Filter system scaling

- 5-7 ATLAS Collaboration, ATLAS: Technical proposal for a general-purpose pp experiment at the Large Hadron Collider at CERN, CERN/LHCC/94-43 (1994)
- 5-8 ATLAS DAQ, ER, LVL2 and DCS: Technical Progress Report, CERN/LHCC/98-16 (1998)
- 5-9 ATLAS Collaboration, ATLAS High-Level Triggers, DAQ and DCS: Technical Proposal, CERN/LHCC/2000-017 (2000)
- 5-10 Summary of Prototype ROBms, ATLAS EDMS Note, ATL-DQ-ER-0001, <http://edms.cern.ch/document/382933/1>
- 5-11 A Prototype Root Builder for the Second Level Trigger of ATLAS Implemented in FPGA's, ATLAS Internal Note, ATL-DAQ-99-016 (1999)
- 5-12 B. Gorini et. al., ROS Test Report, in preparation
- 5-13 ATLAS TDAQ: A Network-based Architecture, ATLAS EDMS Note, ATL-DQ-EN-0014, [https://edms.cern.ch/document/391572/0\\_4](https://edms.cern.ch/document/391572/0_4)
- 5-14 Network performance measurements as part of feasibility studies on moving part of the ATLAS Event Filter to off-site Institutes, K. Korcyl et. al., 1st European Across Grids Conference, February 13th-14th, 2003, Universidad de Santiago de Compostela, Spain



## 6 Fault tolerance and error handling

### 6.1 Fault-tolerance and error-handling strategy

Error handling and fault tolerance are concerned with the behaviour of the TDAQ system in the case of failures of its components. Failure, here, means the inability of a component, which may be hardware or software, to perform its intended function.

The overall goal is to maximize system up-time, data-taking efficiency and data quality for the ATLAS detector. This is achieved by designing a robust system that will keep functioning even when parts of it are not working properly.

Complete fault tolerance is a desired system property which does not imply that each component must be able to tolerate every conceivable kind of error. The best way for the system to achieve its overall goal may well be to simply reset or reboot a component which is in an error state. The optimal strategy depends on the impact that the faulty component has on data taking, the frequency of the error, and the amount of effort necessary to make the component more fault tolerant.

The fault-tolerance and error-handling strategy is based on a number of basic principles:

- Minimize the number of single points of failure in the design itself. Where unavoidable, provide redundancy to quickly replace failing components. This might consist of spare parts of custom hardware or simply making sure that critical software processes can run on off-the-shelf hardware which can be easily replaced.
- Failing components must affect as little as possible the functioning of other components.
- Failures should be handled in a hierarchical way, where local measures are taken to correct failures. Local recovery mechanisms will not make important decisions, e.g. to stop the run, but pass the information on to higher levels.
- Errors are reported in a standardized way to make it easy to automate detection and handling of well-defined error situations (e.g. with an expert system).
- Errors are automatically logged and the record made available for later analysis if necessary. Where the error affects data quality the necessary information will be stored in the conditions database.

The following actions can be distinguished.

Error detection describes how a component finds out about failures either in itself or neighbouring components. Errors are classified in a standardized way and may be transient or permanent. A component should be able to recover from transient errors by itself once the cause of the error disappears.

Error response describes the immediate action taken by the component when it detects an error. This action will typically allow the component to keep working, maybe with reduced functionality. Applications which can sensibly correct errors that are generated internally or occur in hardware or software components they are responsible for should correct them directly. In many cases the component itself will not be able to take the action necessary to cure failures in a

neighbouring component. Even if the component is unable to continue working, this should not be a fatal error for the TDAQ system if it is not a single point of failure.

Error reporting describes how failure conditions are reported to applications interested in the error condition. The mechanism will be a standardized service which all components use. The receiver of the error message might be persons (like a member of the shift crew or an expert) or an automated expert system.

Error recovery describes the process of bringing the faulty component back into a functioning state. This might involve manual intervention by the shift crew, an expert, or an automated response initiated by the expert system. The time-scale of this phase will typically be longer than the previous ones and can range from seconds to days (e.g. in the case of replacing a piece of hardware which requires access to controlled areas).

Error prevention describes the measures to be taken to prevent the errors from being introduced in hardware or software. Good software engineering, the use of standards, training, testing, and the availability and use of diagnostic tools help in reducing the error level in the TDAQ system.

### 6.2 Error definition and identification

In order to respond to error conditions it is important to have a clearly-defined TDAQ-wide classification scheme that allows proper identification of errors. It is assumed that error conditions are detected by DataFlow applications, controllers, event-selection software, and monitoring tasks. These conditions may be caused by failures of hardware they control, of components that they communicate with, or these may occur internally.

If the anomalous condition cannot be corrected immediately an error message is issued. Error messages are classified according to severity. The classification is necessarily based on local judgements; it is left to human/artificial intelligence to take further action, guided by the classification and additional information provided by the applications that detect the errors.

Additional information consists of a unique TDAQ-wide identifier (note that status and return codes, if used, are internal to the applications), determination of the source, and additional information needed to repair the problem. Messages are directed to an Error-Reporting Service, never directly to the application that may be at the origin of the fault.

For successful fault management it is essential that correct issuing of error messages be enforced in all TDAQ applications.

### 6.3 Error-reporting mechanism

Applications encountering a fault make use of an error-reporting facility to send an appropriate message to the TDAQ system. The facility is responsible for message transport, message filtering, and message distribution. Optional and mandatory attributes are passed with the messages. The facility allows receiving applications to request messages according to the error severity or other qualifiers, independent of origin of the messages. A set of commonly used qualifiers will be recommended. These can, for example, include the detector name, the failure type (e.g. hardware or software), or finer granularity indicators like 'Gas', 'HV' etc. Along with mandato-

ry qualifiers like process name and id, injection date and time, and processor identification, they provide a powerful and flexible system logic for the filtering and distribution of messages.

Automatic message suppression at the sender level is foreseen to help avoid avalanches of messages in the case of major system failures. A count on the suppressed messages is kept. Message suppression at the level of the message-reporting system is also possible.

An error-message database is foreseen to help with the standardization of messages including their qualifiers. A help facility can be attached which allows the operator to get detailed advice for the actions to be taken for a given failure.

## 6.4 Error diagnosis and system-status verification

Regular verification of the system status and its correct functioning will be a vital operation in helping to avoid the occurrence of errors. A customizable diagnostics and verification framework will allow verification of the correct status of the TDAQ system before starting a run or between runs, automatically or on request. It will make use of a suite of custom test programs, which are specific for each component type, in order to diagnose faults.

## 6.5 Error recovery

Error-recovery mechanisms describe the actions which are undertaken to correct any important errors that a component has encountered. The main goal is to keep the system in a running state and minimize the consequences for data taking.

There will be a wide range of error-recovery mechanisms, depending on the subsystem and the exact nature of the failure. The overall principle is that the recovery from a failure should be handled as close as possible to the component where the failure occurred. This allows failures to be dealt with in subsystems without necessarily involving any action from other systems. This decentralizes the knowledge required to react appropriately to a failure and it allows experts to modify the error handling in their specific subsystem without having to worry about the consequences for the full system.

If a failure cannot be handled at a given level, it will be passed on to a higher level in a standardized way. While the higher level will not have the detailed knowledge to correct the error, it will be able to take a different kind of action which is not appropriate at the lower level. For example, the higher level might be able to pause the run and draw the attention of the member of the shift crew to the problem, or it might take a subfarm out of the running system and proceed without it.

The actual reaction to a failure will depend strongly on the type of error. The same error condition, for example timeouts on requests, may lead to quite different actions depending on the type of component in which the error occurs. A list of possible reactions is given in Section 6.8.

Each level in the hierarchy will have different means to correct failures. Only the highest levels will be able to pause data taking or to stop a run.

The functionality for automatic recovery by an expert system will be integrated into the hierarchical structure of the TDAQ control framework and can optionally take automatic action for

the recovery of a fault. It provides multi-level decentralized error handling and allows actions on failures at a low level. A knowledge base containing the appropriate actions to be taken will be established at system installation time. Experience from integration tests and in test-beam operation will initially provide the basis for such a knowledge base. Each supervision node can contain rules customized to its specific role in the system.

## 6.6 Error logging and error browsing

Every reported failure will be logged in a local or central place for later retrieval and analysis. The time of occurrence and details on the origin of the failure will also be stored to help in determining the cause and to build failure statistics, which should lead to the implementation of corrective actions and improvements of the system. Corresponding browsing tools will be provided.

## 6.7 Data integrity

One of the major Use Cases for error handling and fault tolerance concerns the communication between sources and and destinations in the system.

Given the size of the TDAQ systems, there is a significant possibility that at any given moment one of the sources of data may not be responding. Each element in the Dataflow can be generally seen as both a source and a destination.

Due to electronics malfunctioning, e.g. a fault in the power supply for a number of front-end channels, it may happen that a source temporarily stops sending data. In this case the best strategy for the error handling is to have a destination that is able to understand, after a timeout and possible retries (asking for data), that the source is not working. In this case the data fragment will be missing and the destination will build an empty fragment with proper flagging of the error in the event header. The destination will issue an error message.

There are cases of communications errors where there is no need for a time-out mechanism. This is, for example, the case of a ReadOut Link fault due to Link Down. The S-LINK protocol signals this situation, the receiving ROS immediately spots it, builds an empty fragment, and reports the link fault. A similar mechanism can also be envisaged for the Front-End electronics to ROD communication that is also established via point-to-point links.

There are many situations where a time-out mechanism is mandatory, for example when the communication between source and destination is using a switched network. In this case possible network congestion may simulate a source fault (e.g. through packet loss). Switched networks carrying event data at high rates are present between the ROS and the Event Building, the ROS and the LVL2, and the Event Building and the Event Filter.

The choice of the correct time-out limits can only be made once the system is fully assembled with the final number of nodes connected to the switches. Only then can the normal operation timing be evaluated via dedicated measurements with real and simulated data. The system timeouts may have to be tuned differently when the system is used for physics and calibration runs. For example, in calibration mode the time for getting a data fragment may be higher due to the bigger amount of data to be transferred from a source to a destination.

## 6.8 Fault-tolerance and failure strategy for hardware components

### 6.8.1 The source end of Readout Links

The ROL is implemented as an S-LINK [6-2] LSC mezzanine installed on the ROD module, or installed on the ROD rear transition module, or integrated into the ROD rear transition module. On the receiver end of the ROL, multiple S-LINK input channels are integrated onto a ROBIn card.

The ROL design uses small form-factor pluggable (SFP) [6-3] fiber optic transceiver modules. In the case of a failure of a fiber optic transceiver, a replacement part can therefore simply be plugged in from the front-panel, avoid the need to power off the ROD crate or the ROS PC. The only implication is that fragments from the faulty ROL will be lost during the operation. Device qualification data from the fiber optic transceiver vendor indicates that less than 1.5% of the devices will fail over a 10 year period. Sufficient spare parts will be available for replacement.

In the case of a failure of an LSC mezzanine card or a ROD rear transition module, the crate will have to be powered off, in order to replace the faulty cards. This will take about five minutes, not counting the time to shutdown and reboot the ROD crate. It is difficult to estimate the failure rate of the LSC mezzanine card or the ROD rear transition modules, however it is expected to be a rare occurrence and sufficient spares will be available for replacement.

In the case of a failure of one of ROL input channels integrated on the ROBIn card, the complete card needs to be replaced, which implies a reboot of the ROS PC with the faulty card. Again this is expected to be a rare occurrence.

### 6.8.2 The Readout System

The Readout System (ROS) is the system that receives, buffers, and dispatches data fragments coming from the Readout links. The ROS is implemented as a number of individual units (up to around 150). Each unit is composed of an industrial PC housing a number of ROBIn modules.

The ROBIn modules are custom PCI devices receiving data from a number of Readout links (between 2 and 4 according to the implementation options) and providing the buffering. The ROBIn boards are based on standard commercial components. Their failure rate is expected to be very low, and detailed studies will be performed when the first prototypes are available.

In the case of a failure of a ROBIn module, the full ROS PC will need to be powered off. An adequate number of spare modules will be available to expedite repairs. The data of all the ROLs connected to the ROS (at least 12) will be unreadable for the full intervention period. An alternative intervention approach will be to dynamically mask out the ROBIn module from the ROS, thus only losing the data of the ROLs connected to the module, and delay the module replacement until the next natural pause of the data taking. The intervention approach will have to be decided on a case-by-case basis, according to the importance of the ROLs connected to the faulty ROBIn module.

The PCs used to house the ROBIn modules will be commercial rack-mounted industrial PCs. The selection criteria for the PCs will require high reliability with such features as redundant power supplies. Every ROS unit is completely independent from the others. Thus the ROS system itself does not need to be reconfigured in the case of a failure with a particular unit/PC, and

it can work with any number of missing PCs. However, any hardware intervention on a ROS PC will imply the loss of all the data from the connected ROLs, and the need to reconfigure the DAQ accordingly. For example, the TTC system will have to be reconfigured to ignore any busy signal coming from the RODs which were connected to the missing ROS. The replacement of a full ROS PC is expected to be, in the best case, at least one hour.

From the software point of view the ROS is being designed to have a lower failure rate than the high-level trigger applications to cause a negligible impact on Data Acquisition efficiency. In particular the ROS software does not make use of any dynamic memory allocation scheme (all needed memory is statically pre-allocated), to eliminate memory leaks. Moreover the communication between the ROS and the HLT applications is based on a request-response, connectionless protocol, thus permitting the ROS to be insensitive to any problems occurring in the HLT applications.

### 6.8.3 The Rol Builder

The LVL1 system produces details about the type and position of the ROLs for all accepted events. The Rol Builder combines and reformats the Rol data it receives from the LVL1 Trigger and passes the Rol information corresponding to each event accepted by LVL1 to a LVL2 Supervisor. The Rol Builder is a critical, unique component using custom hardware. It is a highly modular system. It consists of two types of cards (input and builder cards). The cards and a controlling PC will reside in a standard VME crate. The card count is small for this system, but the cards are custom built. Since the system is critical for taking data, the cost of maintaining a substantial pool of replacements is low compared to the risk of not having adequate spares. The current plan is to include a reserve of spares and to run with some hot spares in the crate being used during data taking. If a builder board fails during data taking it can be replaced with a hot spare by simply reconfiguring the system via the DAQ. It is expected that laboratory space at CERN will be set aside for repair and that a backup system (crate, builder, and input boards) will be kept there in the event of more catastrophic whole system failure (e.g. a power supply failure that causes damage to multiple components in the crate).

### 6.8.4 Network

The topology of the TDAQ networks is 'star based', using several large central switches, and many concentrating switches, which are attached to the central switches using fiber Gigabit Ethernet links. A catastrophic failure of the central switches would stop the experiment, while a failure of a concentrating switch would loose part of the detector data or the processing farm attached to it.

Therefore, the central switches should have redundant power supplies, redundant CPU modules, and a redundant or at least hot swappable switching matrix. If the switch line cards are not hot swappable, there should be a few (one or two) standby line cards, in order to minimize the down time of the switch in the case of a line card failure. To ease technical support and availability of spare parts, the central switches should be as similar as possible (ideally identical).

The use of multiple central switches in the Data Collection network improves the fault tolerance. In the case of a total failure of one central switch, the system can still operate at a lower rate, until the failing switch is repaired or replaced. A concentrating switch failure does not bring down the entire network. If a ROS concentrating switch fails, then the corresponding part

of the detector is unreadable, and one may decide to stop the experiment, or continue running with reduced detector coverage. If a processor farm concentrating switch (such as the L2PU or the EF farms concentrating switches) fails, the corresponding farm will be excluded from the system configuration, and the system will continue to operate with a slightly lower processing capacity. Failures in concentrating switches can be dealt with by keeping an adequate number of spares and replacing the faulty units.

### 6.8.5 Rack-mounted PCs

The HLT/DAQ system will contain very large numbers of rack-mounted PCs. The reliability of modern PC hardware is generally high and particularly so for most rack-mount PCs, as these are aimed at server markets where reliability is given a higher priority than for individual desktop machines. Indeed part of the cost premium of rack-mounted PCs is due to the greater care taken over the choice of components, better cooling, and ease of maintenance when something does go wrong.

Nevertheless with so many machines, faults will be an issue both in the hardware and the software.

For the hardware the most likely issues will be disk faults, cooling problems, and power supply failures. During normal data taking many of the PCs should not be accessing disk data, indeed for the most time-critical applications any such accesses risk to degrade substantially the performance. For these machines disk access is required for booting the PC, for configuration of the applications, and for recording monitoring data. All of these could be done across the network from a local file server (it is planned that each rack of PCs will have such a file server) but it remains to be seen if this gives a better solution than using a local disk for some of the data accesses. Other machines require very high levels of disk access (the file servers, event store, etc), and for these RAID arrays are assumed, which not only reduces the susceptibility to disk errors, but also allow faulty drives to be replaced without stopping the host PC.

Cooling is a critical issue and several precautions are planned. Studies are underway, in collaboration with the other LHC experiments, to investigate the efficiency of water-cooled heat exchangers (suitable for horizontal air-flow) to be placed at the back of the racks. All of the PCs will include on-board temperature sensors, and data from these will be monitored as part of the general farm management so that operator intervention can be requested if required. In addition the PCs include features to reduce the clock speed if over-heating occurs, if this is not sufficient the PC will shutdown.

For the most critical PCs, redundant power supplies are foreseen. This includes the ROS PCs, the central file servers, and the DFM, since failures of any of these would cause a major impact to data taking. For the processors in the HLT Farms where the failure of a single PC would lead to just a small reduction in data-rate no such provision is planned. Should there be a power failure to the building, only the file-servers and event store are planned to be on UPS so that these machines can be shut down in an orderly way, thus reducing the risk of corrupting the file system. Putting all of the machines onto UPS would reduce the time to recover and avoid some hardware failures, but at a cost of a very large UPS system. Also the faster time to recover from a power failure would be of little benefit as it will take some while for the detector to be ready for data-taking, during which time the bulk of the machines can be rebooted and reconfigured.

All of the above hardware problems are likely to require operator intervention at some point, but the system is designed to minimize the impact of the failure and to make replacement of the

faulty components as simple as possible - e.g. ensuring that individual PCs can be removed from racks with minimal disturbance to cabling.

Faults due to software problems are likely to be much more frequent than hardware problems. Operating system (LINUX) crashes should represent only a very small fraction of software errors, but care will be taken to ensure that these are not exacerbated by inadequate machine resources (e.g. insufficient memory, inadequate disk size for log files). Most software related failures will be in the applications or individual threads within applications.

### 6.9 Use Cases

In the following, a short list is given of possible errors and reactions at different levels (from inside an application to system wide), and the impact on data taking:

- Symptom: Readout Link is down (LDOWN) is active on S-LINK), status register and LEDs show error:
  - Action: Online Software should perform a reset of the ROL. If the ROL stays down after reset, prepare to mask BUSY from the ROD in order to continue taking data. Warn the person on shift that the ROL has a fault.
  - Impact: Data from the ROD connected to the ROL will be missing from the event. The ROS will produce empty ROB fragments with a specific error status flag.
- Symptom: Readout Link Data transmission error (bit set in trailing control word of fragment).
  - Action: Flag the Event Fragment, increment the error counter in the ROS.
  - Impact: The HLT will decide, depending on the type of error, whether to use or reject the fragment.
- Symptom: timeout for requests to a ROS inside a LVL2 node.
  - Action: Retry a configurable number of times.
  - Impact: Parts of an event might be missing. If not successful, the LVL2 trigger might not be able to run its intended algorithms and the event has to be force-accepted. If the error persists, the data-taking efficiency might drop because the event building will be busy with forced-accept events.
- Symptom: a dataflow component reports that a ROS times out repeatedly.
  - Action: Pause the run, remotely reset the ROS component and if successful resume the run. If not successful, inform all concerned components that this ROS is no longer available and inform the higher level (who might decide to stop the run and take other measures like calling an expert to re-configure the DAQ).
  - Impact: Data missing in every event.
- Symptom: a LVL2 supervisor event assignment to a LVL2 node times out.
  - Action: Retry a configurable number of times. If this happens repeatedly, take the node out of the LVL2 Supervisor's scheduler list and report to a higher level.
  - Impact: Available LVL2 processing power reduced but it might be possible to re-connect the LVL2 node if the fault can be repaired. The failing event could be forced.

bly accepted for more detailed offline analysis (as assigning the same event to another LVL2 node could possibly bring this node down too).

- Symptom: None of the nodes in an EF subfarm can be reached via the network (e.g. in the case of a switch failure).
- Action: Take all affected nodes out of any scheduling decisions (e.g. in the DFM) to prevent further timeouts. Inform higher level about the situation.
- Impact: Data taking rate capability is reduced.
- Symptom: HLT algorithm or data converter crashes (LVL2 or Event Builder).
- Action: Similar to communications failure: the crashed node is temporarily taken out of the partition and brought back up again: the offending event is saved for offline scrutiny. Repeated crashes of many nodes may be indicative of faulty software, possibly the result of running with a new version or an untested trigger menu. In this case the run may need to be stopped and more drastic action (reverting to an older software version or different trigger menu) is required.
- Impact: For sporadic errors the impact is similar to communications failure. The not unlikely case of running with faulty software leads to a longer loss due to change of run. The trigger may be less selective in case one is forced to run with a reduced trigger menu.

As can be seen, the same error condition (e.g. timeouts for requests) leads to quite different actions depending on the type of component. Each ROS is unique in that its failure leads to some non-recoverable data loss. A LVL2 node on the other hand can be easily replaced with a different node of the same kind.

## 6.10 References

- 6-1 A. Bogaerts et. al. ATLAS TDAQ Fault Tolerance and Error Handling Policy and Recommendations, ATL-D-OR-0002,  
<http://cdms.cern.ch/document/392826/>
- 6-2 S-LINK Interface Specification,  
<http://hsi.web.cern.ch/HSI/s-link/spec/spec/s-link.pdf>
- 6-3 Small Form-factor Pluggable (SFP) Transceiver MultiSource Agreement (MSA),  
<http://schelto.com/SFP/SFP%20MSA.pdf>

## 7 Monitoring

### 7.1 Overview

Fast and efficient monitoring is essential during data-taking periods as well as during the commissioning of the detector. The quality of the data sent to permanent storage must be monitored continuously. Any malfunctioning part of the experiment must be identified as soon as possible. The types of monitoring information may be events, fragments of events, or any other kind of information (histograms, counters, status flags, etc.). These may come from the hardware, processors, or network elements, either directly or via the DCS. Some malfunctions can be detected by the observation of a single piece of information and could be performed at the source of the information. Infrastructure has to be provided to process the monitoring information and bring the result to the end user (normally the shift crew).

Collecting monitoring information can be done at different places in the DataFlow part of the TDAQ system: ROD crate, ROS, and SFI. Additional monitoring information can be provided by the LVL2 trigger and by the Event Filter since they will decode data, compute tracks and clusters. LVL2 and the EF will count relevant quantities for simple event statistics, for monitoring the functioning of the various trigger stages, and for tracking their selection power.

Monitoring information that is collected may be processed locally, e.g. in the ROD module, or in dedicated processes running in the Event Filter. Additional processing may be done by a dedicated Online Monitoring Farm possibly also used for calibration activities. Results will be sent to the shift crew in the control room.

It is clear that monitoring cannot be precisely defined at this stage of the development of the experiment and should therefore be kept as flexible as possible. The ideas presented in this section are the result of a discussion that has started recently at the level of the whole ATLAS community [7-1], [7-2]. The ideas are bound to evolve during the preparation of the experiment, as well as during its lifetime.

### 7.2 Monitoring sources

#### 7.2.1 DAQ data flow monitoring

##### 7.2.1.1 Front-end and ROD monitoring

Here, sub-detector front-end electronics and ROD module specific monitoring is addressed. It deals with:

- data integrity monitoring. Sampled event fragments must be collected at the level of the ROD and sent to dedicated monitoring processes to check the consistency of the data and the headers. Comparisons at the different levels of the transfers must be done. Use of the Data Collection network is preferred for this operation.

- operational monitoring. Throughput and similar information, scaler counters, histograms produced by the RODs must be transferred to the end user for further analysis via the control network.
- hardware monitoring, in cooperation with DCS. Additional monitoring of the hardware, not accessible to DCS (e.g. internal functioning of PCBs) may be provided at this level.

##### 7.2.1.2 Data Collection monitoring

Here, it is DAQ specific monitoring which is addressed. The same points as the one listed in the previous sections will be addressed, at the level of the Data Collection (ROB, Event Builder, SFI, SFO):

- data integrity monitoring
- operational monitoring (throughput and similar, scaler histograms)
- hardware monitoring.

#### 7.2.2 Trigger monitoring

##### 7.2.2.1 Trigger decision

The general philosophy of the trigger decision monitoring is to re-evaluate the decision of each trigger level on samples of both accepted and rejected events in order to confirm the quality of the decision.

##### 7.2.2.1.1 LVL1 decision

The LVL1 decision (for LVL1 accepts) is cross-checked when doing the LVL2 processing. In addition, a pre-scaled sample of minimum-bias LVL1 triggers will be passed to dedicated processing tasks (possibly in a dedicated partition of the Event Filter or in an Online Monitoring Farm).

##### 7.2.2.1.2 LVL2 decision

The LVL2 decision (for LVL2 accepts) is cross-checked when doing the EF processing and pre-scaled samples of events rejected at LVL2 will be passed to the EF. Detailed information on the processing in LVL2 is appended to the event (via the PROS) for accepted and force-accepted events. This will be available at the EF for further analysis.

##### 7.2.2.1.3 EF decision

Detailed information will be appended to the event, for a sub-set of accepted and rejected events for further offline analysis.

#### 7.2.2.1.4 Classification monitoring

For monitoring, classification is a very important output of both LVL2 and EF processing. It consists of a 128-bit bitmap which records which signatures in the trigger menu were passed. Histograms will be filled locally on the processors where the selection is performed. With a maximum accept rate of 3.3 kHz for LVL2 and 200 Hz for EF, and assuming a sampling rate of 0.1 Hz, a 1 byte depth is sufficient for the histograms. For both LVL2 and EF farms, the bandwidth for the transfer of the histograms is therefore 3.5 kbyte/s.

#### 7.2.2.1.5 Physics monitoring

In addition to classification monitoring, the simplest approach to monitoring the quality of the physics which is sent to permanent storage is to measure the rates for some physics channels. It can be performed easily in the EF. A part of the result of these monitoring operations will be appended to the event bytestream for offline analysis. Other data will be sent to the operator via the standard Online Software media for an online analysis and display.

An interesting approach to the physics monitoring could consist of a set of prescaled physics triggers with relaxed thresholds to monitor both the trigger decision and the effect of the trigger sharpness. Further studies will be performed to explore this approach.

Histograms of the rates for every item of the trigger menu as a function of time will be recorded, with the relevant variables with which they must be correlated (e.g. the instantaneous luminosity). Such histograms can very quickly give evidence of any malfunctions, although their interpretation may be quite tricky.

Well-known physics channels will be monitored so that one will permanently compare the observed rates with the expected ones. The list of such channels will be established in collaboration with the physics groups.

Information coming from the reconstruction algorithms executed for selection purposes in the EF may be of interest. One will monitor, for example, the number of tracks found in a given detector or the track quality at primary and secondary vertex on a per event basis. There again, a comparison with reference histograms may be of great help in detecting malfunctioning. Physics quantities will be monitored, e.g. mass-plots of W and Z, n-jet rates, reconstructed vertex location, quality of muon-tracks, quality of calorimeter clusters, and quality of ID tracks. Input is required from offline reconstruction groups.

#### 7.2.2.2 Operational monitoring

This section covers all aspects related to the 'system', e.g. the transportation of the events or event fragments, the usage of computing resources, etc.

##### 7.2.2.2.1 LVL1 operational monitoring

The integrity and correct operation of the LVL1 trigger hardware will be monitored by processes running in trigger crate CPUs, and also by monitoring tasks in the Event Filter.

The LVL1 trigger is the only place where every bunch crossing is processed and where a crude picture of the beam conditions can be found. For example, the calorimeter trigger fills histo-

grams in hardware of the trigger-tower hit rates and spectra. This is done for every trigger tower and can quickly identify hot channels which, if necessary, can be suppressed. Hardware monitoring is used to check the integrity of links between different parts of the LVL1 trigger, e.g. between the calorimeter trigger preprocessor and the cluster and jet/energy-sum processors. The Central Trigger Processor (CTP) will be monitored mainly at the ROD level, using internal scalars and histograms. It will include beam monitoring, including scaling of the trigger inputs on a bunch-to-bunch basis.

After the Event Builder, monitoring tasks, running in the Event filter or in a dedicated Monitoring Farm, will check for errors in the trigger processors on a sampling basis. This will be a low rate, but will have high diagnostic power since details of the LVL1 calculations can be checked. Event Filter tasks will also produce various histograms of trigger rates, their correlation, and history.

##### 7.2.2.2 LVL2 operational monitoring

The LVL2 selection software runs within the framework provided by the Data Collection (DC) in the L2PU. It will therefore use the DC infrastructure and hence the monitoring tools foreseen for this system. The following relevant aspects of LVL2, will be monitored:

- trigger, data, and error rates
- CPU activity
- queue occupancies (load balancing).

Other valuable pieces of information for monitoring which could be performed by LVL2 processing units are:

- LVL2 selectivity per LVL1 trigger type
- number of Rols per Rol type
- Rol occupancies per sub-detector
- Rol specific hit-maps per sub-detector.

In contrast to these data which do not require much CPU power, the monitoring of the quality of the data by LVL2 processors is not envisaged. Indeed, the available time budget is limited because of the necessity to release data from the ROB. Monitoring a fraction of the events in the L2PU is not desirable since this would introduce large variations in LVL2 latencies as well as possible points of weakness in the LVL2 system. The necessary monitoring of the LVL2 quality is therefore delegated to the downstream monitoring facilities, i.e. the EF (or online monitoring farm) and the offline analysis. One should however discuss very carefully the opportunity for the L2PU to fill some histograms, possibly read at the end of the run, so that high statistics information is given. This information can not reasonably be obtained by using events selected by forced accepts on a pre-sampled basis. The evaluation of the extra CPU load for such operations should be made.

##### 7.2.2.2.3 EF operational monitoring

The monitoring of the data flow in the Event Filter will be done primarily at the level of the Event Filter data flow (EFD) process. Specific EFD tasks, part of the main data flow, will be in charge of producing relevant statistics in terms of throughput at the different levels of the data

flow: They have no connection with other processes external to EFD. The detailed list of information of interest for the end user has not yet been finalized and will continue to evolve throughout the lifetime of the experiment.

Among the most obvious parameters which are going to be monitored, one might quote:

- the number of events entering the Farm
- the number of events entering each sub-farm
- the number of events entering each processing host
- the number of events entering each processing task
- the number of events selected by each processing task, as a function of the physics channels present in the trigger menu
- the same statistics as above at the level of the processing host, the sub-farm, and the Farm.

Other statistics may be of interest such as the size of the events, as a function of different parameters (the time, the luminosity of the beam, and the physics channel).

The results of the data flow monitoring will be sent to the operator via standard Online Software media (e.g. IS or Histogram Service in the present implementation).

#### 7.2.2.2.4 PESA SW operational monitoring

A first list of parameters which could be monitored for debugging purposes and comparison with modelling results can be given:

- time spent in each algorithm
- frequency at which each algorithm is called
- number of steps in the step sequencer before rejection
- info and debug messages issued by the PESA SW
- number of active input/output trigger elements.

Some of these points could be monitored during normal data taking.

Profiling tools, such as NetLogger for coarse measurements and TAU, have already been studied in the context of LVL2, and their use on a larger scale will be considered by the PESA software team.

It is intended to make use of the ATHENA Histogramming service, which should therefore be interfaced to the EF infrastructure. Some control mechanisms should be provided to configure the various monitoring options and to operate on the histograms (e.g. to reset them after having been transferred).

### 7.2.3 Network monitoring

Monitoring the TDAQ network activity is essential during the data taking period. A very large number of switches (several hundreds) will be included in the network. Their management and

monitoring is crucial. A first experience has been gained with the testbed used for network and data flow studies. Requirements are presented in [7-3].

Preliminary studies have been undertaken for tool evaluation. A first evaluation of the tool used by CERN-IT (Spectrum, from Aprisma) has been made. It has been found quite mature and it offers most of the expected functionality. Nice graphical interfaces are available giving an accurate and explicit view of the system (Figure 7-1). Extra work will be required to integrate the tool with the Online Software environment.

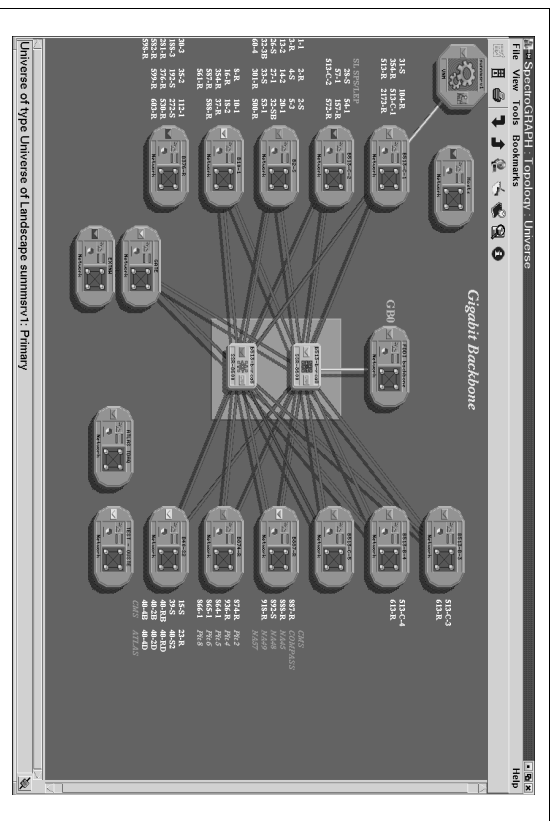

Figure 7-1 Example of a user interface of the Spectrum tool

### 7.2.4 Detector monitoring

The detector monitoring can be done at different places in the DataFlow part of the TDAQ system: ROD Crate, ROS, and SFI. Moreover, additional monitoring can be provided by the LVL2 trigger and by the Event Filter due to the fact that these programs will decode data, compute tracks and clusters, count relevant quantities for simple event statistics, and monitor the functioning of the various trigger levels and their selection power.

The ROD level is the first place where the monitoring of the data quality and integrity can be easily done. The computing power provided, for example, by the DSPs installed directly on the ROD board allows sophisticated calculations to be performed and histograms to be filled. Sending these histograms to analysis workstations will then be performed by the ROD crate CPU (using the Online Software tools running on this CPU).

Some detectors will need a systematic monitoring action at the beginning of the run to check the integrity of the system. This concept has already been introduced at the test beam by the Pixel



sub-detector. At the beginning of the run and at the end there are special events with start and end-of-run statistics. The need for having this first check of the data at the ROD level is driven by the huge amount of information. If monitored later, the back tracking of possible problems would be complicated. The frequency of this activity, for normal operation, can be limited to the start and end of run.

Larger parts of the detector are available at the ROS level (compared to the ROD level), and monitoring at this level is therefore considered as a potentially interesting facility. A correlation between ROS crates is not seen as needed because such a correlation may be obtained at the SFI level. Event fragments sampled at the level of the ROS could be routed to dedicated workstations operated by the shift crew.

When information from several detectors is needed, the natural place to monitor it is after the Event Builder. The SFI is the first place where fully-assembled events are available. The monitoring at the level of the SFI is the first place in the data flow chain where the calorimeter, muon spectrometer, and LVL1 information is available. This can be used, for example, to cross-check the data for LVL1 calorimeter trigger towers against the more-precise, fine-granularity calorimeter readout. Moreover at the SFI level a first correlation among sub-detectors is possible and is seen as extremely useful.

When the monitoring requires some reconstruction operations, it seems natural to try to save computing resources by re-using the results obtained for selection purposes and therefore to execute this activity in the framework of the EF. In addition, some detectors plan to perform monitoring at the level of event decoding, i.e. in the bytestream conversion service, and to fill histograms during the reconstruction phase associated with the selection procedure in the EF. These histograms should be sent regularly to the shift operators and archived. More sophisticated monitoring operations might require longer execution times. However, since CPU power available in the EF should be kept in first priority for selection, it seems more efficient to have a dedicated monitoring farm running beside the EF.

Finally, some monitoring activities such as calibration and alignment checks may require events with a special topology selected at the level of the Event Filter. For instance, the Inner Detector group plans to perform the alignment of the tracking system online. This requires thousands of selected events, to be either stored on a local disk or fed directly to the processing task. Then CPU intensive calculations are required to invert matrices which may be as large as  $30000 \times 30000$ . With a cluster consisting of 16 PCs (as available in 2007, i.e. 8 GHz dual CPU PC with 1 Gbyte of fast memory and a 64-bit floating point arithmetic unit), this can be completed in less than one hour. A very efficient monitoring of the tracker alignment can therefore be performed. Similar requirements are made by the Muon Spectrometer for the purpose of monitoring and calibration operations.

### 7.3 Tools for monitoring

This section describes where and how (i.e. with which tools) monitoring operations will be performed.

#### 7.3.1 Online Software services

The Online Software (see Chapter 10) provides a number of services which can be used as a monitoring mechanism which is independent of the main data flow stream. The main responsibility of these services is to transport the monitoring data requests from the monitoring destinations to the monitoring sources, and to transport the monitoring data back from the sources to the destinations.

There are four services provided for different types of monitoring information:

- **Event Monitoring Service** — responsible for the transportation of physics events or event fragments sampled from well-defined points in the data flow chain and delivered to analysis applications. These will examine and analyse the data in order to monitor the state of the data acquisition and the quality of the physics data in the experiment.
- **Information Service** — responsible for the exchange of user-defined information between TDAQ applications and is aimed at being used for the operational monitoring. It can be used to monitor the status and various statistics data of the TDAQ sub-systems and their hardware or software elements.
- **Histogramming Service** — a specialisation of the Information Service with the aim of transporting histograms. It accepts several commonly used histogram formats (ROOT histograms for example) as the type of information which can be sent from the monitoring sources to the destinations.
- **Error Reporting Service** — provides transportation of the error messages from the software applications which detect these errors to the applications which are responsible for their monitoring and handling.

Each service offers the most appropriate and efficient functionality for a given monitoring data type and provides specific interfaces for both monitoring sources and destinations.

#### 7.3.2 Computing resources for monitoring

##### 7.3.2.1 Workstations in SCX1

It is foreseen to have several workstations in the the SCX1 Control Room near the experiment pit. These workstations will be owned and operated by the sub-detector crews who are on shift. They will receive, via the Ethernet network, the results coming from operations performed in ROD and ROS crates as well as event fragments. Whether the network is a dedicated one or the general-purpose one is still an open question. These workstations will perform subsequent treatment such as histogram merging or event display. They may possibly delegate processing to machines in remote sites if available local CPU power is not sufficient. Results of monitoring operations will be made available to the whole shift crew using the dedicated Online Software services.

##### 7.3.2.2 Monitoring in the Event Filter

From the beginning of the design of the EF, it has been foreseen to perform some monitoring activities there, in addition to the ones related directly to the selection operation. EF is indeed the first place in the data-selection chain where the full information about the events is available.

Decisions from the previous levels of the trigger system can be checked for accepted events and for those that would normally have been rejected, but were retained on the basis of a forced accept. Information coming from the reconstruction phase, which generally requires a large amount of CPU power, can rather easily be re-used, leading to large savings in terms of computing resources.

Monitoring in the EF can be performed in different places:

- directly in the filtering tasks (which raises the problem of the robustness of the monitoring code),
- in dedicated monitoring tasks running in the context of the Event Filter (here one should think of passing the information gathered in the filtering task to take profit of the CPU power already used).

As already stated, the first priority of the EF must be the selection procedure which should not be jeopardized by introducing some CPU-intensive applications in the processing host. Monitoring in the EF should therefore be reserved to light-weight applications which would profit most from re-using pieces of information produced by EF Processing Tasks.

### 7.3.2.3 Monitoring after the Event Filter

In order to perform the CPU-intensive monitoring activities such as the ones described at the end of Section 7.2.4, a dedicated Online Farm should be provided. Such a farm is also necessary to perform the various calibration tasks which do not require the full offline framework. It would be fed by events specially selected in the EF, as well as directly by the general DataFlow through one or more dedicated SFIs (so that it may receive events selected at previous stages of the data acquisition chain). Such specially selected events may be events rejected at LVL1 or LVL2 (on a prescaled basis), or events tagged for calibration purposes (physical as well as non physical events, e.g. generated by a pulser or corresponding to empty bunches).

If such an Online Farm were to be used, one would require that the Data Flow Manager be able to route events towards specific SFIs according to a tag set at various levels of the data acquisition chain (front end, LVL1, or LVL2). The DataFlow framework developed for the Event Filter seems to be well suited for the distribution of the events to the different applications. Moreover, a uniform approach for the EF and the Online Farm would bring some flexibility for the global computing power usage, since intensive monitoring is likely to be more required during commissioning or debugging phases while physics quality is not the first priority, and conversely. The size of this Online Farm is still to be evaluated.

### 7.3.2.4 Network requirements

#### 7.3.2.5 A monitoring matrix is presented in Network requirements

A monitoring matrix is presented in Chapter 2.

## 7.4 Archiving monitoring data

Data which are produced by monitoring activities should be archived by some bookkeeping service so that they can be cross-checked offline with more detailed analysis. One must also store events whose acceptance has been forced at any level of the selection chain. These events are necessary to evaluate precisely the acceptance of the trigger. Details of the archiving procedure will be established in cooperation with the Offline Computing group.

## 7.5 References

- 7-1 B. Di Girolamo et al., Introduction to Monitoring in TDAQ, ATL-D-OR-001, <https://cdms.cern.ch/document/382428/1>
- 7-2 B. Di Girolamo et al., ATLAS Monitoring Requirements, in preparation
- 7-3 M. Zurek, Network Management Requirements, <https://cdms.cern.ch/document/391577/0.7>

# Part 2

## System Components

## 8 Data-flow

This chapter presents the results of studies that have been performed to validate the baseline DataFlow architecture presented in Chapter 5. As the studies have been performed with a prototype implementation of the baseline DataFlow architecture a brief description of the detailed design and implementation is also given, building on the high level designs presented in Chapter 5.

The results are presented according to the major functions that must be performed by the DataFlow: detector readout, message passing, network studies, Rol collection and event building.

The performance of the overall DataFlow system is presented in Chapter 14.

### 8.1 Detector readout and event fragment buffering

#### 8.1.1 ROD crate data acquisition

ROD Crate DAQ comprises all the software and hardware to operate one or more ROD Crates and is deployed on the ROD Crate Processor (RCP)<sup>1</sup> of the ROD Crate and a controlling PC [8-21]. It provides the functionality of configuration, control and monitoring of one or more ROD crate systems independently of the rest of the DataFlow system. This fulfils the detector community's requirements of operational independence during their commissioning and calibration procedures. This model also allows the timescale for the deployment and commissioning of the DataFlow to be decoupled from that of the detector's readout needs. During normal experiment operations the same ROD crate DAQ is operated as an integral part of the overall DAQ.

A block diagram of ROD crate DAQ is shown in Figure 8-1. Event data flows into the RODs via

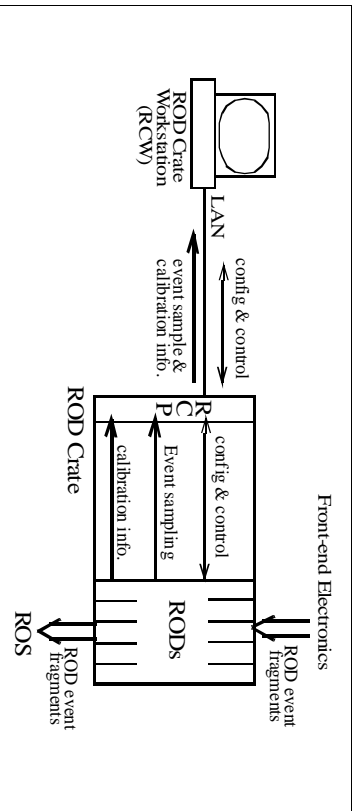

Figure 8-1 Block diagram of the context and contents of ROD Crate DAQ

the FELs and out via the S-LINK. ROD Crate DAQ provides for the sampling of ROD event

1. The RCP is implemented by a Single board Computer (SBC).

fragments within this flow. The sampling may be from a ROD, a set of RODs<sup>1</sup> within the same crate or one or more ROD crates. In addition to the sampling of ROD event fragments, ROD crate DAQ also provides for the retrieval of the results of calibration procedures performed within the RODs. Subsequently the sampled data may be further analysed, recorded to mass storage or in the case of calibration data written to a database. The detector requirements on the sampling rate is O(Hz) [8-21]. This non-demanding requirement allows the sampling from one or more ROD crates to be done over a LAN using TCP/IP, thus simplifying certain aspects of the design and implementation.

The framework of ROD Crate DAQ is organized into four layers: hardware, operating system, low-level services, and high-level tasks. The latter are based on a skeleton which implements detector independent functionality and for an identified set of functions may be extended to meet detector specific requirements.

ROD Crate DAQ re-uses DataFlow and Online software where possible. The ROD Crate controller is an extension of the Local Controller developed for the ROS, see Section 8.1.3.1, and as such implements all the functionality provided by the Online software for configuration, control and monitoring. In addition, other ROS software modules are used to provide the high-level task skeleton and low-level services. A prototype system is being developed, now in conjunction with detector specific developers, and a first distribution is scheduled for June 2003 [8-22].

#### 8.1.2 ReadOut link

Sub-detectors transmit event data accepted by the LVLL over front-end links and use RODs to multiplex the data. Each of the sub-detectors has different requirements and consequently the implementation of the ROD varies between sub-detectors. The guidelines for designing the ROD are set out in the Trigger & DAQ Interfaces with Front-End Systems: Requirement Document [8-1]. The purpose of the ROL is to connect the sub-detectors to the TDAQ system and it is responsible for transmitting error-free data from the output of the ROD to the input of the ROS, i.e. the RobIn.

The ROL requirements have been stable since the High-level Triggers, DAQ and DCS Technical Proposal TP [8-2]:

- 32 bit data at 40.08 MHz, (~ 160 Mbyte/s)
- A control bit to identify the start and end of an event
- Xon/Xoff flow control
- Error detection, error rate < 10<sup>-12</sup>
- A maximum length of 300 m for the fibre version, 25 m for the electrical version.

To ensure homogeneity, the output of the ROD is defined by the S-LINK specification [8-3]. In addition, the raw event format [8-4] defines the order and content of the information transmit-

1. The coherent sampling from one or more RODs depends on the implementation of the ROD.

ted from the ROD. At the other end of the ROL, the ROS inputs are identical for all sub-detectors and also conform to the S-LINK standard.

The S-LINK specification has been stable since 1996. It is an interface definition; it only defines a protocol and recommends connector pin-out. As shown in Figure 8-2, the ROD end of the ROL is called the Link Source Card (LSC) and the ROS end the Link Destination Card (LDC). They are connected by optical fibres or copper cables. Event data flows from the LSC to the LDC on the forward channel. Flow control information, i.e. the ROS can stop the ROD sending data if input buffers are almost full, flows from the LDC to the LSC on the return channel.

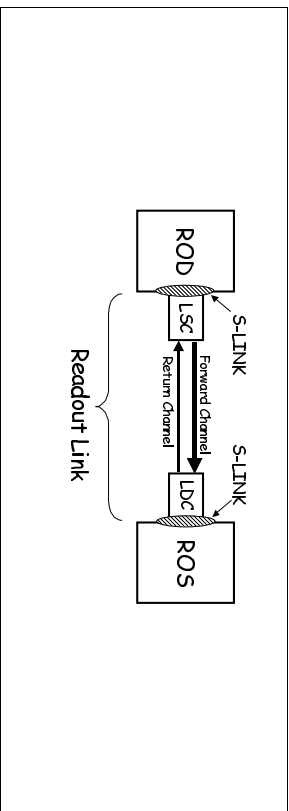

Figure 8-2 The relationship between the S-LINK and the ROL

The DIG - ROD Working Group have also recommended that the LSC be placed on a mezzanine card to facilitate support and upgradeability [8-5]. The form factor of these mezzanine cards is based on the CMC [8-6] standard.

The LSC plugs onto the S-LINK connector on the ROD (or its associated rear transition card). For the forward channel, a field-programmable gate array (FPGA) handles the protocol and delivers words to a serial/deserialiser (SERDES) chip which performs parallel-to-serial data conversion and encoding. The output of the SERDES drives an optical transmitter that in turn feeds the optical fibre. The operation of the receiving card, the LDC, is a mirror image of the LSC. In fact the current LSC and LDC are physically the same card with different programs in the FPGA.

Various prototype implementations of the ROL have been built to prove the concept and measure the performance. A previous version of the ROL, the ODIN, used a physical layer that was based on the Hewlett Packard G-LINKS (HDMF-1032/1034). These have also been used successfully in test-beams and eighty of these ROLs are being used in the COMPASS experiment. However the maximum bandwidth is limited, by the G-LINK, to 128 Mbyte/s. Following the second ROD workshop, the requirements of the ROL were increased to 160 Mbyte/s and a second version of this link was designed which used two G-LINKS chips per channel. This raised the cost as two pairs of fibres and associated connectors are required.

Another recommendation of the ROD Working Group was to build a ROL that would use only one pair of fibres. This has been achieved by using 2.5 Gbit/s components in the current design, the High-speed Optical Link for ATLAS (HOLA) [8-7]. In this implementation a small FPGA, the EP20K30E APEX 20K, handles the S-LINK protocol. The SERDES chip is a Texas Instruments TLK2501 running at 2.5 Gbit/s for both the forward and the return channels (one per card). For the optical transmitter, the Small Form Factor Pluggable Multimode 850 nm 2.5 Gbit/

s with LC Connectors is recommended, e.g. the Infineon VZ3818-N305-B57. The use of pluggable components allows the optical components to be changed in case of failure.

Test equipment has been developed for the ROD/ROL/ROS. This includes an emulator that can be placed on the ROD to check that the ROD conforms to the S-LINK specification. Similarly, an emulator exists that can be placed on a ROS to emulate a ROL connector. The emulators allow ROL, ROL and ROS designs to be tested at full bandwidth and errors to be introduced in a controlled manner. The HOLA was produced and tested in 2002 and satisfies all requirements of the ROL.

In addition, for the purposes of exploitation in laboratory test set-ups and in test-beams, i.e. further testing, cards exist which allow the ROL to be interfaced to the PCI Bus in a PC. Performance measurements of this interface [8-8] have shown that data can be transferred into a PC at 160 Mbyte/s using a single ROL input. Modifications to the firmware have allowed the emulation of an interface with four ROL inputs. Measurements using this emulator have demonstrated a bandwidth of 450 Mbyte/s into a PC. The latest version of the interface, the FLAR, has been produced and tested in 2003. It incorporates four ROLs and could be tested during the course of 2003 test-beams.

The purchase of the cards, in small quantities, is handled by the CERN stores. For quantities required for ATLAS a tendering process will be initiated in 2003 thus ensuring the availability of larger quantities during 2004. The production schedule will be adapted to the requirements of the sub-detectors who have been asked by the DIG to provide estimates of quantities for the years up to the start of the LHC. Maintenance and short-term loans of equipment will be handled by CERN.

## 8.1.3 ReadOut subsystem

### 8.1.3.1 High Level Design

The ROS has three major components: the RobIn, the IOManager and the LocalController. Figure 8-3 shows the relationship between the three ROS components and other relevant TDAQ components. A complete high level design covering both the software and hardware aspects of the prototype ROS can be found in [8-9], only a summary is presented here.

The RobIn component provides the temporary buffering of the individual ROD event fragments produced by the RODs, it must receive ROD event fragments at the LV1a accept rate, i.e. 100 kHz. All incoming ROD event fragments are subsequently buffered for the duration of the LV1.2 trigger decision and, for approximately 4% of the events, the duration of the event building. In addition, it must provide ROD event fragments to the LV1.2 trigger and, for events accepted by the LV1.2 trigger, ROD event fragments to the Event Building.

Due to these requirements the baseline RobIn is custom designed and built. The design of the prototype is described in Section 8.1.3.2.

The IOManager is deployed in the bus-based ROS scenario. It services the requests for data by the L2PUs and the SFI. According to the criteria specified in the data request, the IOManager collects one or more ROB fragments from one or more RobIns, builds a ROS fragment and sends it to the destination specified in the original data request. The IOManager also receives from the DFM the request to release buffer space occupied by ROD event fragments in the Rob-



termed the switch-based ROS. These terms reflect that in each case data from a number of RobIns is collected exclusively via a PCI bus or an Ethernet switch.

To allow these two I/O scenarios to be further studied the prototype RobIn features both a PCI bus and a Gigabit Ethernet interface. The basic set of services, e.g. data request and clears, that the prototype RobIn provides via these interfaces is defined via a single software interface [8-15], and those operations which are related to a specific I/O interface have been encapsulated in separate modules. It is envisaged that the design of the final RobIn will be realised by removing and not by adding functionality, e.g. all buffer management performed by the FPGA or the removal of the Ethernet interface.

### 8.1.3.3 Implementation and performance of the ROS

The deployment of the bus-based ROS is shown in Figure 8-5. It consists of two types of nodes: a ROS PC and the prototype RobIn. The former is a desktop PC running the Linux operating system and has at least one Ethernet connection for the purpose of communication with the On-line system. In addition, it has four 64 bit / 33 MHz and 3.3 V PCI bus slots. These slots are used to host three prototype RobIns. The IOManager via the Message Passing Interface (see Section 8.3.1.3) receives data requests and release messages, and returns ROS event fragments to the High Level Trigger components.

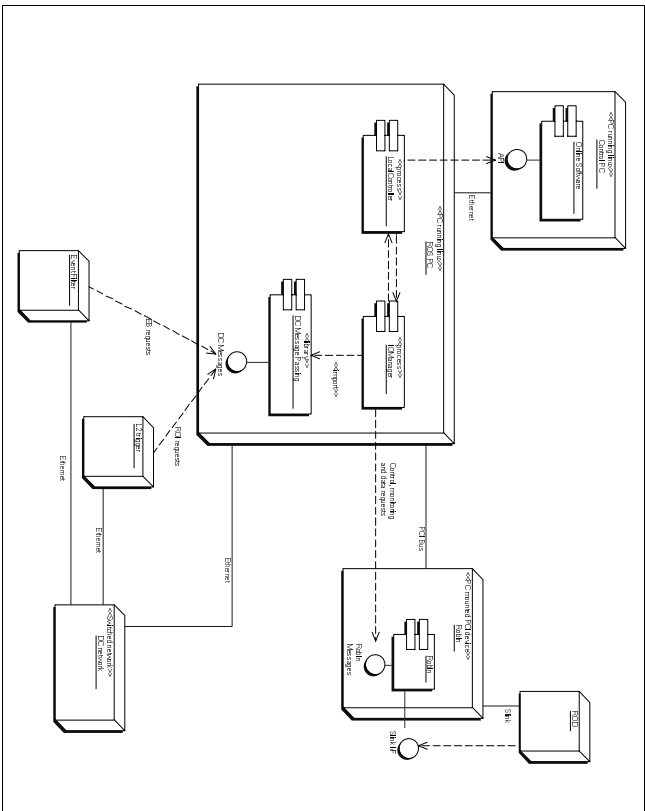

Figure 8-5 Deployment of the bus-based ROS in the baseline DataFlow

Figure 8-6 shows the deployment of the switched-based ROS. Data requests and clears are received directly by the RobIns via its Gigabit network interface, i.e. without passing via the IOManager.

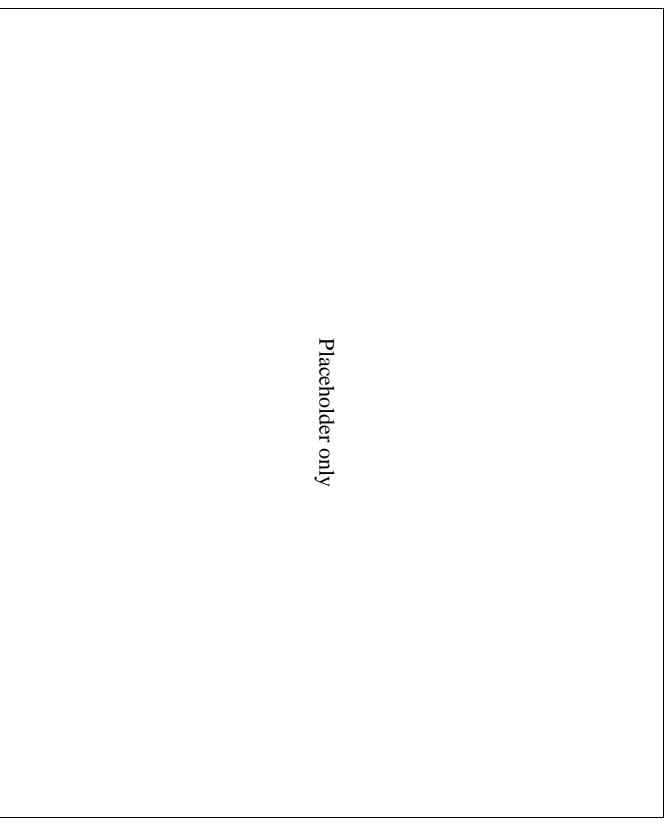

Figure 8-6 Deployment of the switch based ROS

Measurements have been made on the performance of these two scenarios. However, the production schedule of the prototype RobIn has not allowed the prototype RobIn to be available for the measurements presented in this chapter. In its absence measurements have been performed with emulators (simple hardware devices providing a subset, I/O, of the RobIn functionality). For the bus-based ROS measurements the emulator was based on the MPRACE board [8-16]. These boards have the same physical PCI bus interface as the prototype RobIn, and thus provide a very accurate emulation of the final device with respect to I/O over a PCI bus, even though their internal performance is limited to half the PCI bus throughput. For the switched-based ROS the gigabit Ethernet testers developed for the evaluation gigabit Ethernet have been used [8-17]. Note that neither flavour of emulator receives ROD event fragments via S-LINK, ROS event fragments are generated on request and sent to the requester via PCI bus or gigabit Ethernet.

The main results obtained from studies of the bus-based scenario are presented here, while the main results of switch-based ROS measurements are presented in conjunction with the results on Rod collection and event building, see Section 8.3.2.2 and Section 8.3.2.3. More detailed results are documented elsewhere [8-18].

Figure 8-7 shows the setup for the bus-based ROS testbed. In this testbed an IOManager was deployed on a standard PC having a single 2.4 GHz Xeon processor and a PCI bus configuration including four 66 MHz / 64 byte PCI bus, running Redhat Linux 7.3. The PC was equipped with three MPTRACE boards, each emulating a Roblin with four ROLs, giving a total of twelve ROLs per ROS.

The testbed has been operated in a standalone configuration, where the IOManager generated triggers internally and the ROS Fragments produced sent no where, and in a configuration where the IOManager was receiving real data request messages from a test program via the network and sending back the ROS Fragments to the requesting process. The first configuration allows the measurement of the performance of the internal ROS operations (scheduling of concurrent data requests, collection of data fragments from the PCI Roblins, building combined data fragments). The second configuration includes the overhead of the network I/O associated with receiving data requests and sending data fragments.

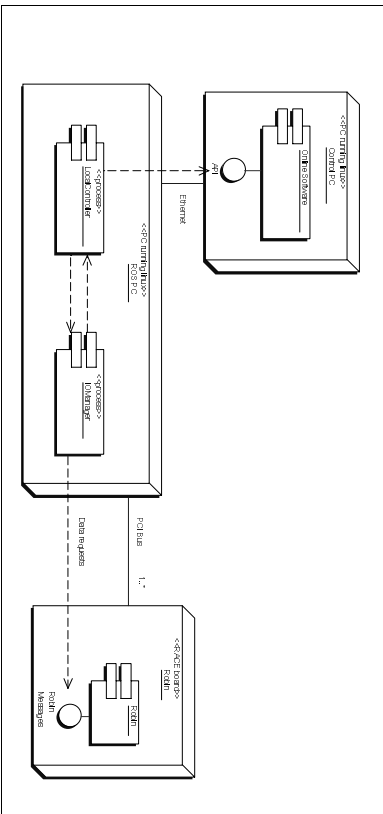

Figure 8-7 The bus-based ROS performance testbed

In the final ATLAS setup, ROS modules will be exposed to a rate of EB data requests depending on the LVL2 rejection power and to different rates of Rol data requests depending on which detector channels they are connected. In addition to the data request messages the ROS will receive messages containing the list of events that have to be removed from its buffers.

The test procedure involved measuring the maximum LVL1 accept rate of that a ROS could sustain as a function of the LVL2 rejection factor. The measurements have been carried out both for average and maximum Rol data request scenarios referred to as "standard" and "hotspot" ROS in the remainder of this section.

The ROI data request rates and throughputs for standard and hotspot ROSs have been derived from the paper model results presented in Appendix A. A standard ROS receives Rol data requests at a rate corresponding to ~ 12% of the LVL1 rate, each requesting one kilo-byte of data from a single ROI. A hotspot ROS instead will receive Rol data requests at a rate corresponding to ~ 20% of the LVL1 rate, each requesting data from one or two ROLs, for a mean output fragment size of ~ 1.4 kbytes. In the final setup the hotspot ROSs will be about XXX% of the total, while the standard ROSes will be about YYY%.

Figures 8-8 shows the maximum sustained LVL1 rate as a function of the fraction of accepted events, i.e. the inverse of the LVL2 rejection power, for both a standard ROS and a hotspot ROS. Also shown, for reference, is the nominal operating point of a ROS: LVL1 rate of 75 kHz, and a LVL2 rejection power of thirty.

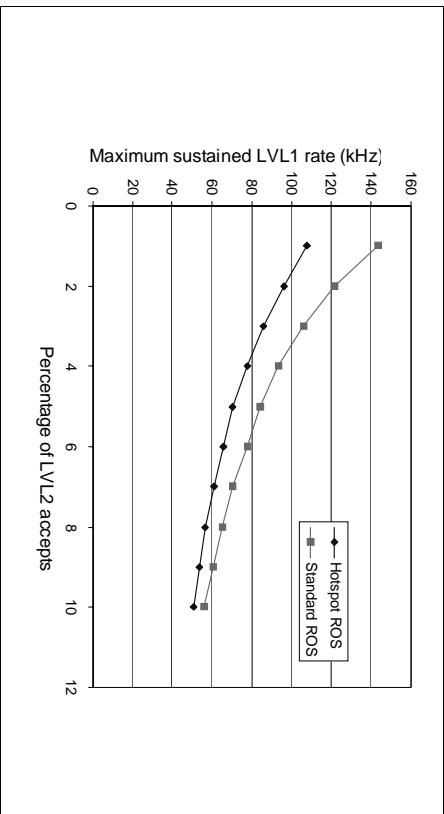

Figure 8-8 The bus-based ROS sustained LVL1 rate as a function of the event building rate for different values of the data volume requested by the LVL2 trigger

It can be seen that for an accept percentage of 4%, i.e. a LVL2 reduction power of twenty-five, a hotspot ROS can sustain up to 78 kHz of LVL1 rate while a standard ROS can sustain up to 94 kHz. It can also be observed that a standard ROS sustains a LVL1 accept rate of 75 kHz for an accept fraction of up to ~ 6.5%, i.e. a LVL2 reduction power of sixteen.

In Figures 8-9 the maximum sustainable LVL1 rate, as shown in figure 8-8 for a hotspot ROS, is compared to the internal performance of the ROS as measured running without network I/O. For the upper curve and for an accept percentage of 4% the fragment flow from the MPTRACE modules is ~ 150 Mbyte/s and increases up to ~ 215 Mbyte/s for an accept percentage of 10%, confirming the observation that the PCI bus can be driven to data rates much larger than that required of the final system.

In summary, it has been shown that the bus based ROS equipped with twelve ROLs on three Roblin emulators meets the worst-case performance requirements (hotspot ROS) and exceeds the requirements by 20% in the normal case (standard ROS), with current off-the-shelf single-processor Linux PCs. The performance of the bus-based ROS, with real or emulated network traffic, is far from being limited by the PCI bus bandwidth and performance gains may be achieved in the near future, due to improvement of PC Hardware, e.g. the replacing of today's 2.4 GHz CPUs with the 4 GHz CPUs that are expected to be commonly available by the end of next year.

In addition significant improvements of performance are expected from on-going software optimization studies: the use of new Linux kernels and/or thread libraries; possible software architecture changes to exploit multi-processor machines; and the optimization of the high-level layers of the message passing software.



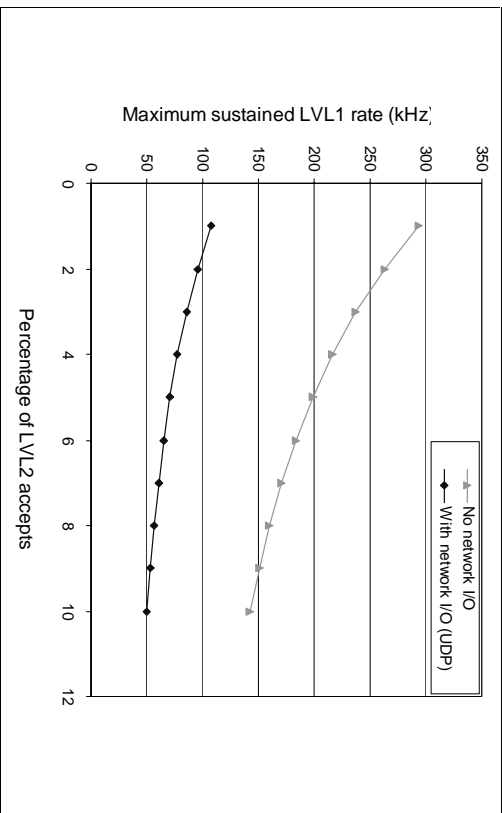

Figure 8-9 The bus-based ROS sustained LVL1 rate with and without network I/O

### 8.1.3.4 PROS

The Pseudo-ROS receives the detailed result records of the L2PUs for accepted events and participates to the event building process, such that the LVL2 detailed result appears within the full event record. As the name indicates it provides ROS functionality specifically for the L2PU. As its input rate is given by the rate of LVL2 accepted events  $O(3 \text{ kHz})$  and the estimated size of the LVL2 detailed result is  $O(1 \text{ kbyte})$ , it is purely a software process receiving event fragments via an Ethernet connection. That is to say that unlike the ROS the I/O demands do not warrant the deployment of a RobIn. From the point of view of the SFI there is no difference between the PROS and the ROS and it is estimated that a single pseudo-ROS is sufficient for the final system. The requirements and design of the PROS are described in [8-19] and [8-20].

## 8.2 Boundary and interface to the LVL1 trigger

The LVL2 trigger is seeded by the Rols identified by the LVL1 trigger. The information from LVL1 includes the selected trigger type and the details of where in  $\eta$  and  $\phi$  the trigger primitives that caused the accept originate. The interface between the LVL1 and LVL2 trigger has been specified [8-23] and is implemented by the RoIB component of the DataFlow.

Figure 8-10 shows the RoIB and its connections to the LVL1 system. The Rols are input to the RoIB on eight separate links at rates of up to 100 kHz. The main function of the RoIB is to collect the individual Rols per LVL1 accept and produce a single data structure which it then relays to the L2SV. To meet the rate requirements, the latter is implemented by a small,  $O(10)$ , farm of PCs each of which runs a supervisor process. The RoIB ensures the flow of information between the LVL1 and DataFlow and is also an integral part of the LVL2 trigger. In this sec-

tion the design and performance of the prototype RoIB are presented. Section 9.2.3 presents those aspects relevant to the correct functioning of the LVL2 trigger; e.g. load balancing.

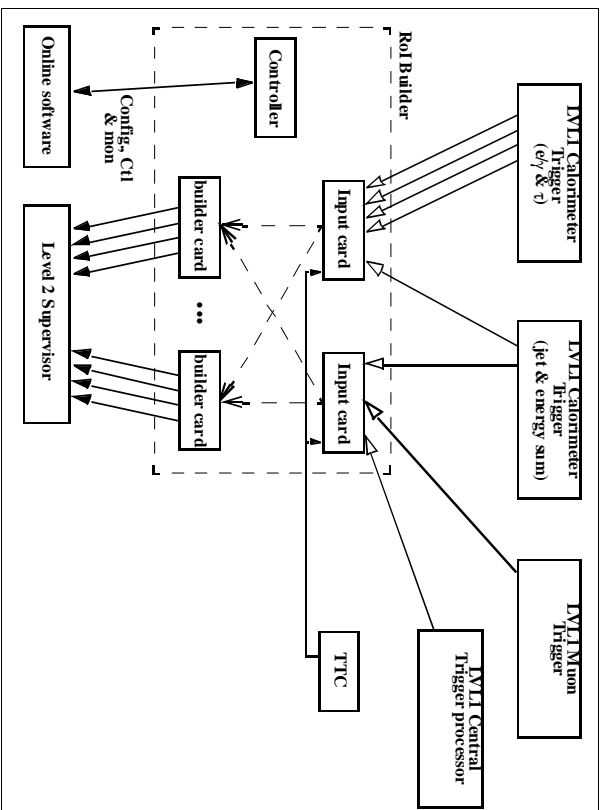

Figure 8-10 RoIB and its connections to the LVL1 system

## 8.2.1 Region-of-interest builder

Referring to Figure 8-10, each major trigger element of the LVL1 system provides RoI fragments to the RoIB via a point to point link. The requirements of this link are matched by those of the RoI, and it is therefore envisaged that this link will be a RoI, i.e. implemented via the S-LINK, see Section 8.1.2. In addition to the eight RoIs TTC input is also foreseen which will allow, particularly during the debugging and commissioning phases, consistency checks of the extended L1ID contained in the received RoI fragment.

The maximum size of the RoI fragment received on each link, per LVL1 accept, is specified [8-23] to be 256 byte. Additionally, the skew between the arrival time of RoI fragments is specified to be less than one millisecond. Studies [8-2] indicate that on average there will be ~ 5 RoIs (primary and secondary) per LVL1 accept which the RoIB assembles the RoI fragments into a RoI record and sends them to a supervisor processor. The selection of supervisor processor is governed by a load balancing algorithm.

### 8.2.1.1 Implementation and performance

The baseline implementation of the RoIB is a VMEbus system which includes a SBC<sup>1</sup> for interfacing with the Online system for the purposes of configuration, control and monitoring. It is composed of two stages: input and assembly. The input stage consists of input cards which receive and buffer the RoI fragments. Each input card is equipped to receive data from up to six RoIs, thus two cards are required in the final system. These cards subsequently send the RoI fragments to 'builder cards' in the assembly stage where the RoI fragments are assembled into

RoI records. Per event, the RoI fragments are sent to all 'builder cards', the assignment of each event to a specific builder card will be based on a token passing mechanism between the builder cards deployed. Each builder card can service up to four supervisor processes. The number of builder cards within the system is not limited and is dictated by the rate that a supervisor process can sustain. The implementation of the baseline architecture foresees ten supervisor processes thus three builder cards.

A prototype of the RoIB has been build and tested during the course of 1999. It was based on a pair of 12U VMEbus cards, an input card capable of handling six S-LINK inputs and a pair of builder cards able to output to a pair of supervisor processes. This implementation utilized 76 Altera 10K40 FPGAs and 8 10K50 FPGAs. The system and early performance measurements are documented in [8-24].

Exploitation has shown that combining RoI fragments from several sources using an FPGA-based device is feasible and that a L2SV consisting of four 300 MHz Pentium II PCs was sufficient to receive the RoIB output rate 100 kHz. Subsequent tests with prototypes of the muon-CTP interface and the calorimeter CPROD modules of the LVL1 system have made a start on debugging the component interfaces and have further demonstrated that external inputs could be handled at the expected rates [8-25].

The exploitation of this prototype also demonstrated a number of issues which are being addressed in the design of the final prototype, due to be implemented in 2003. EXPAND ON THE ISSUES OR DROP SENTANCE.

## 8.3 Control and flow of event data to high level triggers

### 8.3.1 Message passing

#### 8.3.1.1 Control and event data messages

The flow of event data between components of the DataFlow system is achieved by the exchange of control messages and subsequent event data messages. This is described in detail in [8-26] and [8-27], here only its major features are summarized. Figure 8-11 is a sequence diagram describing the handling of an event by the DataFlow components.

The sequence commences with the reception ..... OF ROI INFORMATION FROM THE LVL1 BY THE ROIB .... by a supervisor process of the LVL1 Result, which contains the RoI information, from the RoIB. Using a load balancing algorithm the supervisor assigns the event to a L2PU for analyse.

The L2PU receives the LVL1 Result from the L2SV and uses the contained RoI information to seed its processing, see Section 9.2.4. The sequential processing performed by the L2PU results, on average, in 1.6 RoI data requests per event. The selected ROS units service the request for data by responding to the requesting L2PU with a ROS event fragment message. On reaching a decision as to whether to the event should be accepted or rejected the L2PU sends the LVL2 Decision message to the supervisor process. In the case that the event is accepted for further processing by the EF the L2PU also sends the detailed result of its analysis to the pROS.

1. The same SBC as used in the ROD crates.

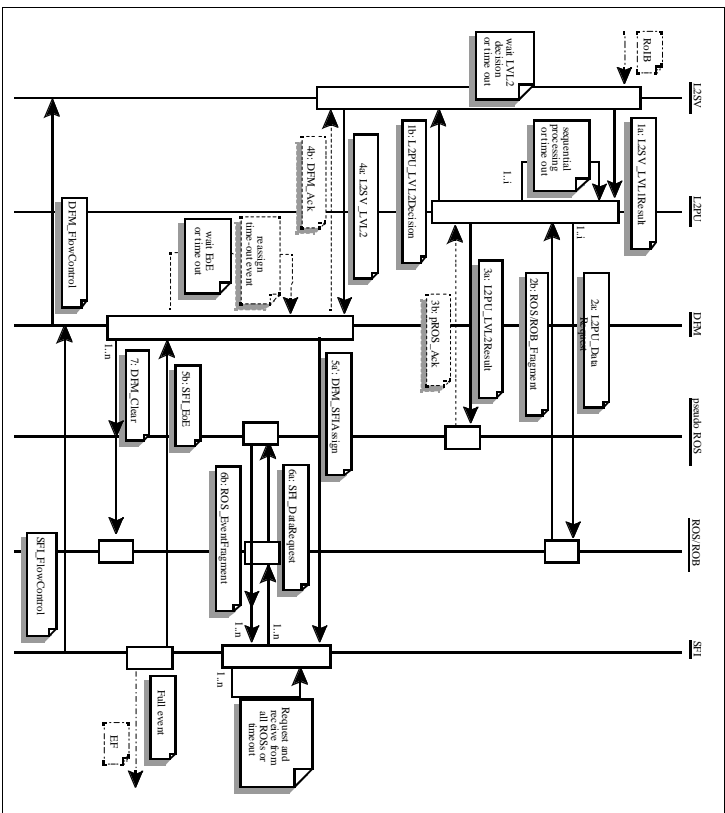

Figure 8-1-1 Sequence diagram showing the interactions between DataFlow components.

The supervisor process receives the LVL2 Decision and forwards a group of them to the DFM. If no LVL2 decision is received within a pre-defined timeout, the supervisor process deems the event to have been accepted by the L2PU and sends a LVL2 Decision to the DFM.

On reception of a group of LVL2 Decisions the DFM acts on each decision and in the case of an accepted event, based on a load balancing algorithm, assigns an SFI to perform the building of the event. A Clear message is multicast by the DFM to all ROSs for events, i.e. those rejected by the LVL2 and those successfully built. This message contains the identifiers of events which have been treated by the system.

The SFI builds the event by sequentially requesting event data from all or some of the ROSs. The built event is subsequently sent to the EF subam for further processing.

Table 8-1 Summarises the messages, in terms of rate and bandwidth, exchanged between the DataFlow component.

The message rates and bandwidth can be handled by a wide range of link technologies. The choice is dictated by price, long term availability, support, inter-operability and suitability for

Table 8-1 Average message rates and bandwidth per DataFlow component

Communicati ng	Message type	Sender Rate (KHz)	Sender Bandwidth (Mbytes/s)	Receiver Rate (KHz)	Receiver Bandwidth (Mbytes/s)	Comment
LVL1 to RolIb <sup>a</sup>	Data	12.5	26	12.5	26	RoI Information
RolIb <sup>b</sup> to L2SV	Data	33	32	7.5	9.8	RoI Record
L2SV to L2PU	Data	7.5	9.8	0.5	0.7	RoI Record
L2PU to ROS	Control	5	0.5	14	1.4	Data requests
		10	1	5	0.5	
ROS to a L2PU	Data	14	28	5	10	Event data
		5	5	10	10	
L2PU to L2SV	Control	0.5	0.05	7.5	0.75	LVL2 decision
L2PU to pROS						L2PU processing output
L2SV to DFM	Control	75	0.04	0.75	0.4	LVL2 decision
DFM to a SFI	Control	3	0.3	0.04	0.004	Assignment to an SFI
SFI to ROS	Control	6	0.6	3	0.3	Data requests
		66	6.6	3	0.3	
ROS to a SFI	Data	3	36	6	66	Event data
		3	3	66	66	
SFI to DFM	Control	0.04	0.004	3	0.3	Indicates event built
DFM to ROSs	Control	0.25	0.4	0.25	0.4	Clear events from buffers
SFI to EF	Data	0.04	66	0.04	66	Event data
EF to SFO	Data					Full event and EF output
SFO to Storage	Data					Full event and EF output

- a. RoIb input port
- b. RoIb output port
- c. Bus-based ROS
- d. Switch-based ROS

DataFlow. Ethernet in its varieties of 100 Mbit/s and 1000 Mbit/s is the prime candidate and has been evaluated for its suitability for exchange of control and event data messages.

### 8.3.1.2 Ethernet

Extensive studies have been performed on many Ethernet features leading to its adoption as the baseline networking technology in the DataFlow. The features studied have included: the char-

acteristics of switches with respect to throughput, packet loss, latency, trunking and Media Access Control (MAC) address table size. Virtual Local Area Network (VLAN) implementation; Flow Control at different levels, i.e. across switch and between Ethernet nodes; Quality of Service (QoS); Broadcast and multicast handling; Inter-operability of switches from various vendors.

The results of studies of all these features are reported in [8-28] and additional references to studies performed on Ethernet can be found in [8-29]. Features of primary importance to the baseline architecture have emerged to be switch throughput, latency, packet loss and, in the case of the switch based ROS, VLANs. The results of studies of these features are summarised in this chapter.

### 8.3.1.2.1 Basic switch performance

Switches must meet the throughput requirements of the architecture with a minimum latency and loss of Ethernet frames. The latter results in a degradation of the system's performance as it implies the use of timeouts and retries at the application level. Frame loss within a switch may occur as a result of a switch dropping frames when it's buffers overflow. Therefore the larger the buffers the smaller the probability of frame loss. Ethernet Flow Control helps prevent buffer overflow within switches, but it does not completely solve the problem of frame loss.

The frame loss and latency of a number of switches have been studied for different frame sizes, loads (from 10% to 100% of the line speed), with Constant Bit Rate (CBR) or with Poisson inter-packet gap, using unicast, multicast and broadcast traffic.

Figure 8-12 shows the results of a test performed on two different switches, using raw Ethernet and 1518 byte frames. These measurements used 30 GE ports, each one sending unicast traffic to all the others with a negative exponential inter-packet gap. Switch 1 became saturated when the offered load exceeded 66% of the line speed. It can further be seen that a slight increase in latency is followed by packet loss, and a significant growth in latency occurs once the switches buffers become full. The second switch (Switch 2 in the figure) in this test performed better, almost achieving line speed.

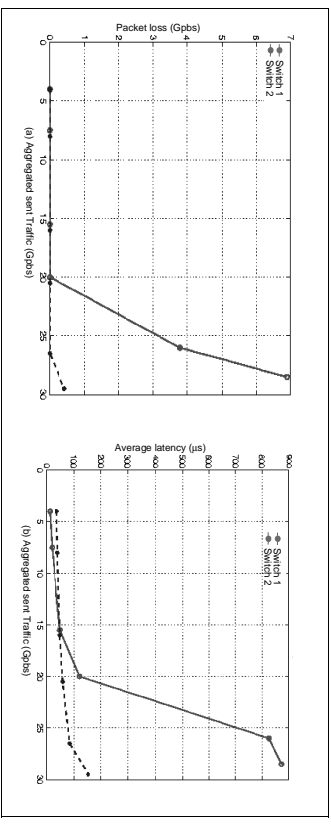

Figure 8-12 Switch measurements for unicast traffic, Poisson inter-packet gap, 1518 byte frames: (a) Frame loss (b) Average latency.

Similar measurements have also been performed using multicast and broadcast traffic. The results show that switch performance is vendor specific and in some cases the maximum throughput is surprisingly low, i.e. less than 10% of the line speed. The avoidance of vendor dependency is one of the reasons for the choice of unicast traffic (a request-response scenario) in the baseline architecture, see Section 8.3.1.1.

In summary, any switch that is to be deployed must operate below a saturation point to avoid latency increase and the subsequent frame loss. This saturation point must be determined by measurement.

The problem of frame loss can be alleviated by the use of Ethernet flow control. However, the propagation of flow control through a switch is manufacturer dependant. The propagation of flow control assures a loss less frame transfer, but once congestion appears it may spread over large areas [8-28]. In switches that do not propagate flow control, frame loss will occur if the congestion cannot be absorbed by the switches internal buffers. However, in this case there is no spreading of congestion. The correct operation of Ethernet flow control must be determined by measurement.

### 8.3.1.2.2 Virtual Local Area Network

The network topology of the proposed architecture CROSS REF. TO SECTION OF CHAPTER 5, using the switch based ROS, contains network loops, see Figure 8-13, which are illegal in the use

of Ethernet as they disturb the MAC address tables for unicast frames and result in the continuous sending of multicast and broadcast messages (broadcast storms). In general the Spanning Tree Protocol (STP) is deployed to disable redundant links in a LAN so as to maintain a loop free topology. In the proposed architecture a loop free topology will be achieved by using two VLANs, one of each associated to the LVL2 and EB traffic. The extended header of the Ethernet frame may include a VLAN tag immediately after the Ethernet addresses allowing many logical LANs, i.e. VLANs, to coexist on the same physical LAN.

The setup shown in Figure 8-13 has been used to verify that VLANs eliminate illegal loops, and to ascertain whether the STP can be applied per VLAN. With the STP disabled tests have shown that VLANs ensured a loop free topology. With the STP enabled one of the links in the loop was disabled indicating that the STP is not implemented per VLAN, at least on the switches used in the tests.

In summary, if the STP cannot be applied per VLAN it can be disabled and VLANs alone used ensure a loop free topology. Note there are indications that most forthcoming switches will implement a STP that can be applied per VLAN.

Not only do VLANs ensure a loop free topology, but they provide additional features: they restrict flooding; provide containment of multicast and broadcast traffic; and provide support for QoS by means of the priority field within the VLAN tag.

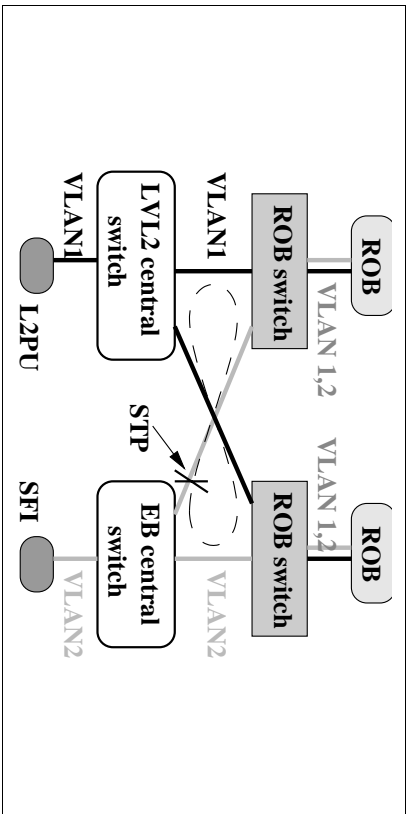

Figure 8-13 VLAN Ethernet loop setup. The potential loop appears in dashed line

### 8.3.1.3 Design of the message passing component

The requirements of the Message passing layer are detailed in [8-30]. It is responsible for the transfer of all control and event data messages between the DataFlow components. It imposes no structure on the data which is to be exchanged and its implementation allows the transfer of up to 64 kbyte of data with a best-effort guarantee. No re-transmission or acknowledgement of data is done by this layer allowing the API to be implemented over a wide range of technologies without imposing an unnecessary overhead or the duplication of existing functionality. The API supports the sending of both unicast and multicast messages. The latter has to be emulated by the implementation if it is not available, e.g. for TCP.

The design of the Message Passing layer [8-31] defines classes that allow the sending and receiving of messages. The Node Group and Address classes are used at configuration time to setup all the necessary internal connections. The Port class is the central interface for sending data. All user data has to be in part of a Buffer object to enable it to be sent or received from a Port. The Buffer interface allows the addition of user defined memory locations which are not under the control of the Message Passing layer to avoid copying. The Provider class is an internal interface from which different implementations have to inherit. Multiple Provider objects can be active at any given time. A Provider is basically the code to send and receive data over a given protocol/technology, e.g. TCP, UDP or raw Ethernet.

### 8.3.1.4 Performance of the message passing

The prototype Message Passing interface has been implemented over raw Ethernet frames, UDP and TCP. TCP provides additional reliability compared to UDP and raw Ethernet. However, applications and message flow have been designed to ensure correct system functioning when an unreliable technology is used, i.e. UDP or raw Ethernet. The raw Ethernet implementation adds message re-assembly on the receiver side to overcome the restriction of the maximum message size being a single Ethernet frame restriction.

Internally all implementations support scatter/gather transmission and reception of data. This allows the building of a logical message out of a message header and additional user data that does not need to be copied inside the application.

Extensive studies of the performance of the Message Passing layer have been performed [8-32]. Figure 8-14 and show the performance of message passing, when streaming, on PCs equipped with 2 GHz CPUs using basic operating system primitives and for the Message Passing. Note that the raw Ethernet measurements are performed with a maximum of 1460 byte, since no re-assembly of larger packets has been implemented.

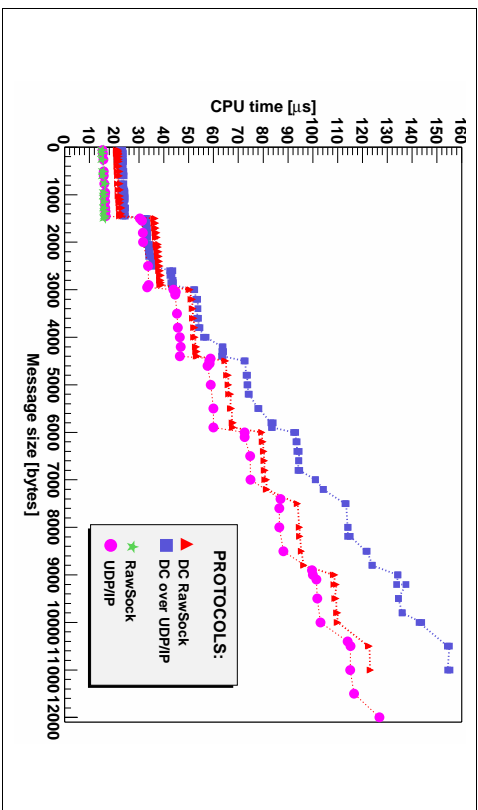

Figure 8-14 Time to service a message versus the length of the message

The main feature observable in these figures is step increase in the time to send a message of  $\sim 8 \mu\text{s}$  at the boundary of multiples of the Ethernet frame size. Within multiples of Ethernet frames the time to send a message varies by less than 1%. Compared to the performance using operating system primitives the Message Passing introduces an additional overhead of  $8 \mu\text{s}$ . In Figure 8-14 it can be observed that the differences between raw Ethernet and UDP/IP are initially small and increase with the message size. Table 8-2 summarises the performance of the prototype Message Passing layer on today's PCs. The CPU time required to send a single Ethernet frame message is  $\sim 12 \mu\text{s}$  and the time required to receive a message is  $\sim 22 \mu\text{s}$ . For multi-frame messages the dependency is  $14.3 \mu\text{s}$  per frame.

**Table 8-2** Summary of the Message Passing performance with raw Ethernet on a 2 GHz PC

Parameter	Time / $\mu\text{s}$
Operating system Interrupt service	10
Operating system Protocol stack	4
Message Passing overhead	8

Over the past few years the CPU time to send and receive messages has decreased substantially. This is largely due to the improvements made in the Linux operating system, which are continuing to be made, e.g. interrupt coalescence A REE, and should lead to proportional improvements in the Dataflow Message Passing layer. The latter adds to the operating system overheads an additional overhead which decrease as CPU speed increases. It is also not excluded that this additional overhead will further decrease as a result of improvements to the design of the Message Passing layer.

## 8.3.2 Data collection

### 8.3.2.1 General overview.

The requirements on the DataCollection are described in [8-33]. In summary it is responsible for the movement of event data from the ROS to the LVL2 trigger and EF and from the EF to mass storage. It includes the movement of the LVL1 Rols to the L2PU (via the L2SV) and the LVL2 result (decision and detailed result) to the EventFilter as well as the EventBuilding and feeding the complete events to the EventFilter. However, DataCollection is not responsible for initializing and formatting (or preprocessing) of event fragments inside the ROS, neither is it responsible for preprocessing nor for trigger decisions in the L2PU or in the EF SubFarm.

A complete description of the DataCollection is described in [8-34]. The DataCollection implements the: L2SV, L2PUA (LVL2 Processing Unit Application, i.e. L2PU low layer functionality), DFM, PROS, SFI and SFO. In their prototype implementation a common approach to the design and implementation has been adopted. This approach leads to the definition of the common DataCollection framework, implementing a suite of common services:

- OS Abstraction Layer
- Access to the configuration Database
- Error Reporting
- System Monitoring

- Run Control
- Message Passing

A typical application is built on top of a skeleton application and only the application specific functionality needs to be implemented.

Services are built from packages following a modular approach. Many of these packages consist only of interfaces whose implementation is provided by other packages which can be changed at configuration or run-time. This clear separation between interfaces and implementations exists down to the lowest levels like, the thread interface and access to system clocks and timers. Examples are the error reporting (switching between simple stdout/stderr and MRS), the configuration database (switching between OKS files and remote database server), the system monitoring (providing an interface to the Information Service of the Online Software and a local independent version). The Message Passing has been described in Section 8.3.1.3.

### 8.3.2.1.1 OS Abstraction Layer

The OS abstraction layer consists of packages hiding all OS specific interfaces. E.g. the threads package hides the details of the underlying POSIX thread interface.

### 8.3.2.1.2 Error Reporting

The ErrorReporting package allows the logging of error messages either to standard out and error or to MRS. Each package can define its own set of error messages and error codes. Error logging can be enabled/disabled on a package by package basis, with a separate debug and error level for each package. Furthermore debug logs and normal error logs are treated logically differently, so the debug message could go to stderr while all normal application logs go to MRS. The user only interfaces via a set of macros to the ErrorReporting system allowing optimization of the applications at compile time.

### 8.3.2.1.3 Configuration Database

All applications make use of the Online Software's configuration database and their design allows the underlying implementation to change without implying changes to the application. The application's view of the database is hidden by configuration objects which access the database, providing a more convenient way to access configuration information. The configuration objects themselves are created automatically from the Configuration Database schema file.

### 8.3.2.1.4 System Monitoring

This package allows every component to make arbitrary information available to some outside client. In practice this is used to publish statistics like counters and histograms. The packages makes this information available in various different ways, including the Information Service of the Online Software.

8.3.2.1.5 Run Control

The run control interface is responsible for translating the requests from the Online Software about state changes into commands for the application. It also provides a skeleton around which one can build an application. These classes realize most of the use cases for run control. They talk to a special DataCollection Run Controller on the one side and application specific code on the other side.

8.3.2.2 RoI data collection

8.3.2.2.1 Design

The interaction between the L2SVs, L2PUs, ROSs and pROS which results in the collection of RoI data leading to a LVL2 Decision with further details in the LVL2 Result is explained in Chapter 9.

8.3.2.2.2 Performance

Each L2SV controls a subfarm of L2PUs. The maximum size of a subfarm is determined by the rate at which the L2SV can handle each L2PU. This is shown in Figure 8-15 using a L2SV with an emulated connection to the RoI Builder. The maximum rate for a farm containing a single L2PU is ~ 30 kHz dropping off slowly as more L2PUs are added. Thus a few L2SVs are sufficient to achieve the maximum design rate of 100 kHz.

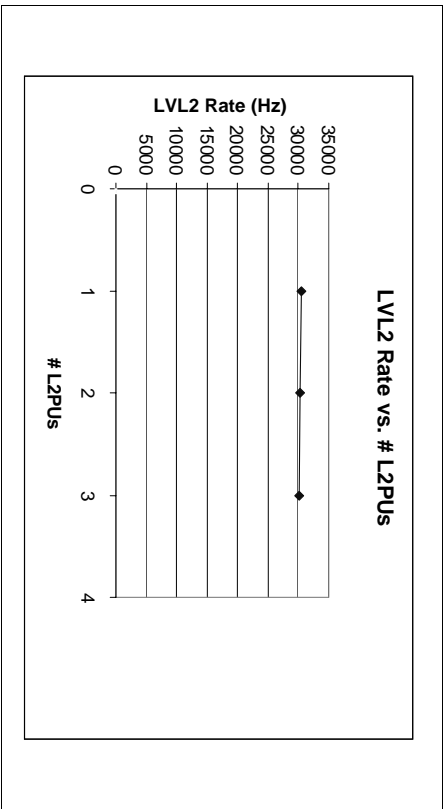

Figure 8-15 Maximum LVL2SV decision rate as a function of the number of L2PUs it controls

The maximum rate at which an L2PU can collect RoI data depends on the size of the RoI, the number of ROSs that contribute data and the number of Worker threads that collect RoI data in parallel on the same L2PU. Figure 8-16 shows 1/Rate for an RoI of 16 kbyte collected as 1, 2, 4, 8, 16 or 22 slices of 16, 8, 4, 2, 1 or 0.8 kbyte respectively, varying the number of Worker threads be-

tween 1, 2, 4 or 8. The L2PU as well as the L2SV and ROS emulators were all dual Xeon CPUs of 2.2 GHz interconnected by Gbit Ethernet. For this test, the L2PUs were completely dedicated to data collection. The plot shows that the time for acquiring RoI data is small compared to the execution time of selection software (currently aimed at 10 ms/event average).

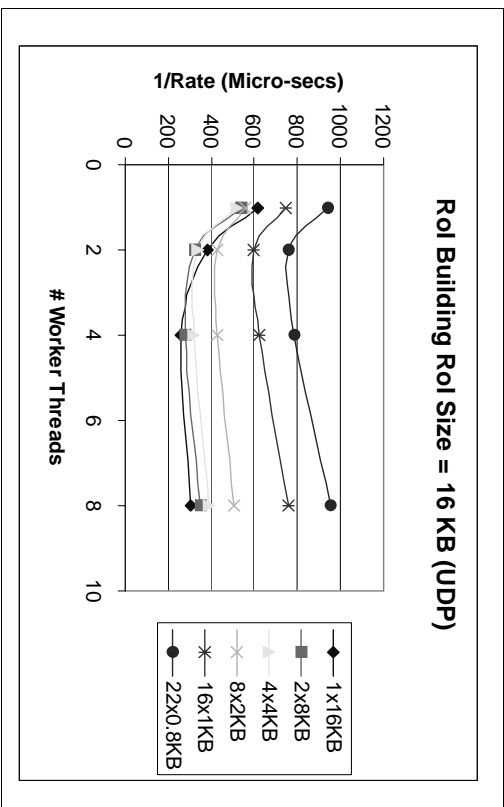

Figure 8-16 Performance of the RoI data collection for an RoI of 16kbyte as a function of the number of Worker Threads. The plot shows 1/Rate collecting data in slices of equal size from 1, 2, 4, 8 or 16 sources

Figure 8-17 summarizes the performance of the RoI data collection for various combinations of RoI sizes and slices for four threads.

The scalability of the RoI data collection has been tested by using two L2SVs, 22 ROS emulators and varying the number of L2PUs from 1 to 8. All nodes were PCs equipped with dual Xeon processors at 2 or 2.2 GHz connected by Gigabit Ethernet. Figure 8-18 shows the obtained RoI rate of the system for 1, 2, 4 or 8 L2PUs collecting RoIs as slices of 6 x 1 kbyte, 3 x 2 kbyte (6 kbyte RoI) and 6 x 4 kbyte or 12 x 2 kbyte (24 kbyte RoI). The unrealistically small number of ROS emulators available for the test causes a deviation from perfect scaling for 8 L2PUs.

8.3.2.3 Event Building

8.3.2.3.1 Design

The interaction between the ROSs, the DFM and the SFI which implements the event building functionality is shown in Figure 8-11 and explained in [8-26]. Two scenarios concerning the interaction between DataFlow components in Event Building are being studied:

- PUSH scenario: In this scenario, the DFM assigns an SFI to all the ROSs via a multicast mechanism. The ROSs then respond to the assigned SFI with their respective ROS event

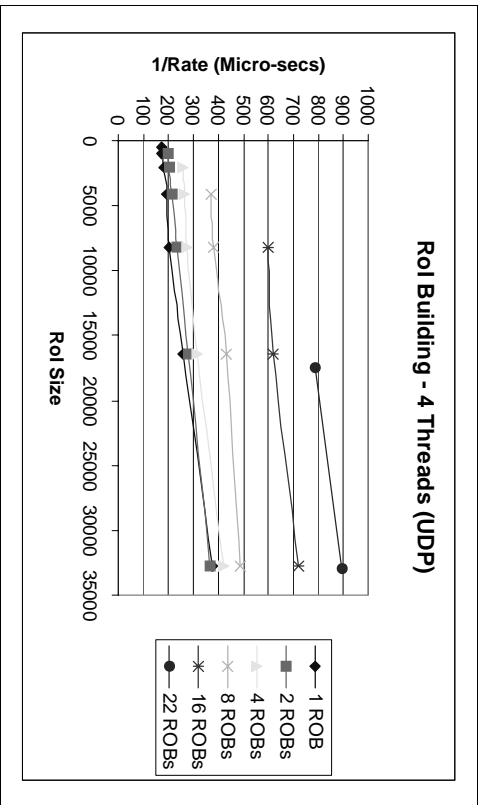

Figure 8-17 Summary of the performance of the Rol data collection for various combinations of Rol sizes and slices

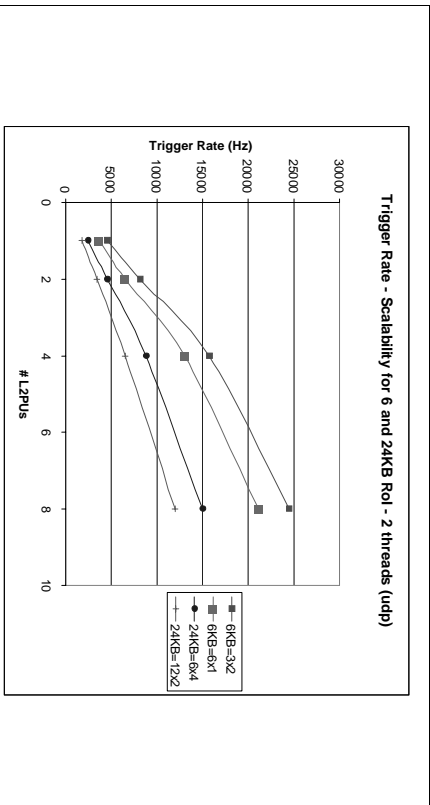

Figure 8-18 Scalability of the data collection is demonstrated by the rate at which as system of 1, 2, 4, or 8 L2PUs collect Rol data from 22 ROS emulators. The unrealistically high L2PU/ROS ratio causes a deviation from perfect scaling for 8 L2PUs

fragment. The SFI acts as an open receiver and builds the complete event out of the individual fragments received.

- PULL scenario: In this scenario, the DFM assigns an event to an SFI. The SFI then requests from each ROS its event fragment via a series of unicast messages. The SFI receives from each ROS individually and builds the complete event.

There is no difference in the amount of messages being handled on the level of the DFM, the ROSs or the network, however, the amount of messages to be handled by an individual SFI is double in case of the pull scenario.

Although a doubling of the message rate at the level of the SFIs may seem problematic, the pull scenario offers the advantages with respect to controlling the flow of traffic. In this mode an SFI at any given moment in time never requests more fragments than it can handle. Thus it smooths out the traffic and reduces the risk for congestion within the network. In the case of the PUSH scenario, the ROSs will need to control the amount of traffic sent to each SFI individually; this can be achieved via applying QoS at the level of the ROS. Detailed studies have been made on the use of IP QoS to avoid congestion in the network. The results of these studies are summarised in Section 8.3.2.3 and further details can be found in [8-35]

### 8.3.2.3.2 Performance

The building of events is performed by the DFM, SFI and ROSs and is the collecting of event fragments of an event located in up to 1628 different buffers. This has to be performed at a rate of ~ 3 kHz. Detailed studies of the event building have been performed [8-36], [8-37] using prototype software, PCs, Ethernet switches and traffic generators, see Section 8.3.1.2 for description of the traffic generators only the principle results are presented here.

The nominal event building rate in the proposed baseline architecture is ~ 3 kHz and commences with the arrival of LVL2 decisions at the DFM. Seeded by this rate, in the pull scenario, the DFM assigns the events to and SFI, receives notification when an event is built and sends clears to the ROSs. The performance of the DFM, defined as the sustained event building rate versus the number of SFIs is shown in Figure 8-19. It can be seen that the prototype implementation of the DFM can sustain an event building rate of up to ~ 23 kHz, an order of magnitude greater than the required performance. Within 5% this sustainable rate is independent of the number of SFIs deployed in the system.

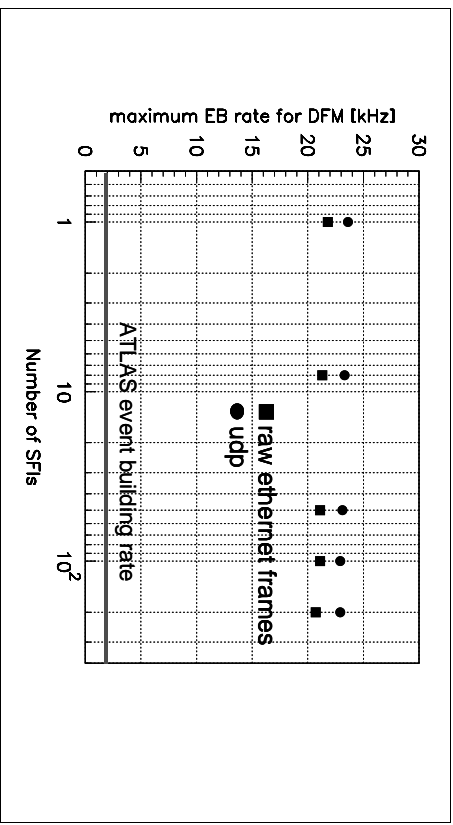

Figure 8-19 The DFM event building rate versus the number of SFIs. Each SFI concurrently builds two events



In Figure 8-20 the sustained event building rate per SFI for the pull scenario is shown as a function of the number of ROLs per ROS. The measurement was performed for an event size of 2.2 Mbyte and the event distributed over 1600 ROLs emulated by 128 emulators. The two curves represent the cases where the SFI forwards the built event to an EF subfarm or not. The results shown in the figure indicate that today's prototype implementation of the event building functionality deployed on PCs (dual processors clocked at 2.4 GHz) achieves an event building rate per SFI 35 Hz. In addition, the bus-based scenario gives a performance gain of ~ 30%.

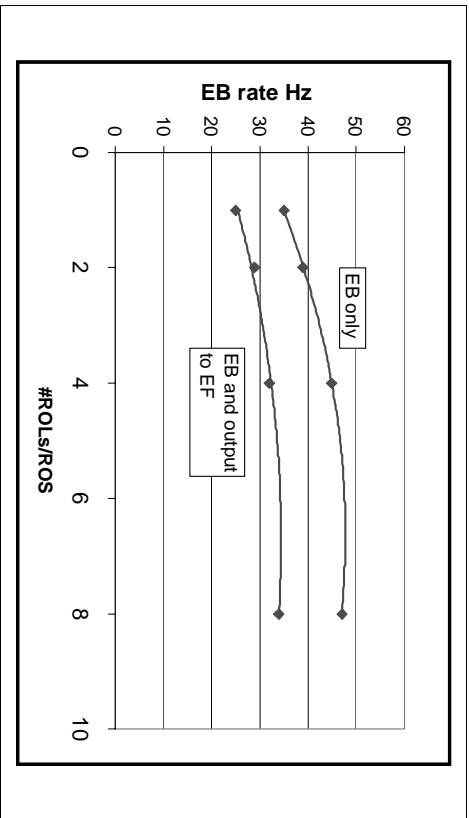

Figure 8-20 The event building rate versus the number of ROLs/ROS in a system with a single SFI

The scalability of the event building is shown in Figure 8-21. In this test the number of SFIs in the set up was increased from one to eight and the corresponding event building rate measure. It can be seen that the sustained event building rate increases linearly with respect to the number of SFIs in the system and that every additional SFI contributes to the overall system performance by ~ 35 Hz.

It should be noted that the results in Figure 8-21 for eight ROLs/ROS were achieved with Ethernet flow control active. The measurements with Ethernet flow control disabled have yet to be understood.

### 8.3.2.3.3 Event Building with QoS

Quality of Service has been implemented in the standard Linux kernel at the IP level and it can be used to shape the traffic entering a switching network. This removes the necessity of implementing traffic shaping at the level of the applications.

QoS manages the flow of data at the IP level by employing packet classification, packet scheduling and traffic shaping techniques. Packet classification is used to classify incoming packets in groups, such as Class Base Queuing (CBQ). The packet scheduler arranges the scheduling for outgoing packets according to the queuing method and the buffer management selected. Token Bucket Filter (TBF) is an example of one method. The outgoing packet are sent at a rate deter-

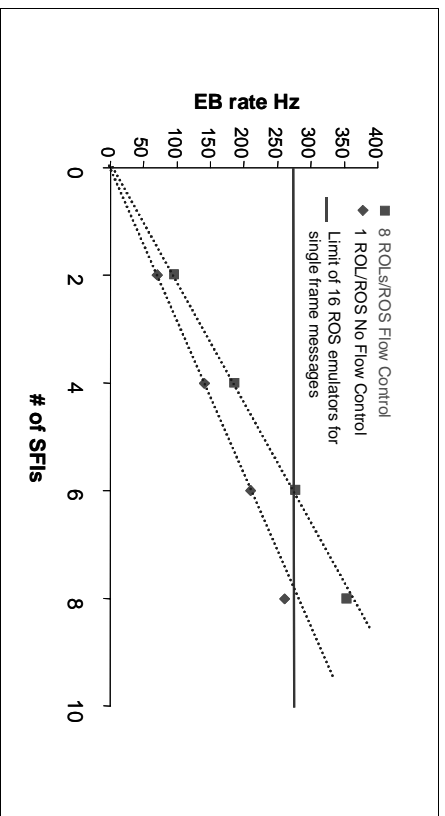

Figure 8-21 The event building rate versus the number of SFIs in the system

mined by the size of the token buffer and the rate in which tokens are supplied. The traffic shaper is a technology to make the burst flat.

Note that QoS as implemented by the Linux kernel is performed only in the message output queues, i.e. at the level of the ROSs, in coming packets continue to be accepted on a best effort basis. It is also important to realize that packets are scheduled at best at the rate of the Linux kernel scheduler, which is a configurable parameter. Event building is to be performed at a rate of ~ 3 kHz, therefore the data should be scheduled to at least the same rate for the traffic shaping to be effective. In the studies performed the Linux kernel scheduling frequency was set to ~ 4 kHz.

The event building performance with QoS applied at the IP level has been measured for the push scenario [8-35]. The results of these studies are shown in Figure 8-22.

In this figure it can be observed that in the case of the push scenario without QoS, packet loss occurs at the SFI when the message size exceeds 4 kbyte. With QoS applied, packet loss is not observed when the QoS is used to limit the output bandwidth at the level of the ROS to 40 Mbit/s.

In the conditions in which no packet loss occurs the push scenario is more performant than the pull scenario due to the additional data control messages implied by the pull scenario. However, over the full range of ROS event fragment sizes being studied for event building, the pull scenario is more performant.

The results, obtained on a small system, show that QoS as a shaping technique is not always effective for event building in the range required. Whether these conclusions are applicable to the full size system remains to be established. Enhancements in the performance of the pull scenario with QoS applied have still to be investigated.

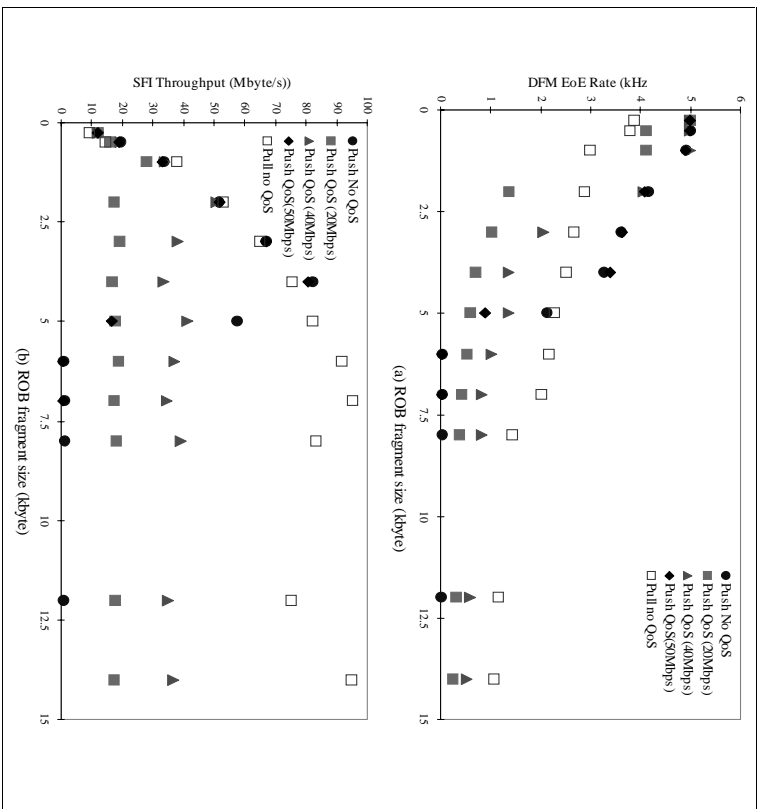

Figure 8-22 (a) Event Building rate and (b) throughput as a function of event fragment size and different QoS parameter values for the push scenario

## 8.4 Scalability

### 8.4.1 Detector readout channels

This section describes quantitatively how the physical size, performance and control and configuration of the system scales with the 'amount' of detector to be read out.

#### 8.4.1.1 Control and flow of event data

How the number of applications, messages and data volume changes.

#### 8.4.1.2 Configuration and control

Amount of configuration data a function of the amount of detector.

### 8.4.2 LVL 1 rate

How the system performance and physical size scales with respect to the LVL 1 rate.

## 8.5 References

- 8-1 Trigger & DAQ Interfaces with Front-End Systems: Requirement Document, [http://atlasinfo.cern.ch/Atlas/GROUPS/DAQTRIG/DIG/archive/document/FEdoc\\_2.5.pdf](http://atlasinfo.cern.ch/Atlas/GROUPS/DAQTRIG/DIG/archive/document/FEdoc_2.5.pdf)
- 8-2 ATLAS High-level Triggers, DAQ and DCS Technical Proposal, CERN/LHC/C/2000-17, 31 March 2000, [http://atlas.web.cern.ch/Atlas/GROUPS/DAQTRIG/SG/TP/tp\\_doc.html](http://atlas.web.cern.ch/Atlas/GROUPS/DAQTRIG/SG/TP/tp_doc.html)
- 8-3 The S-LINK Interface Specification, [http://edmsorweb.cern.ch:8001/ceder/doc/info?document\\_id=110828](http://edmsorweb.cern.ch:8001/ceder/doc/info?document_id=110828)
- 8-4 C. Bee et al., The raw event format in the ATLAS Trigger & DAQ, <http://preprints.cern.ch/cgi-bin/setlink?base=atlnot&categ=Not&id=daq-98-129>
- 8-5 Recommendations of the Detector Interface Group - ROD Working Group, <https://edms.cern.ch/document/332389/1>
- 8-6 The CMC standard, Common Mezzanine Cards as defined in IEEE P1386/Draft 2.0 04-APR-1995, Standard for a Common Mezzanine Card Family: CMC (the CMC Standard).
- 8-7 Design specification for HOLA, <https://edms.cern.ch/document/330901/1>
- 8-8 Procedures for Standalone ROD-ROL Testing, G. Lehmann et al., 27 July 2001, ATC-TD-TP-0001 [http://edmsorweb.cern.ch:8001/cedardoc/info?document\\_id=320873&version=1](http://edmsorweb.cern.ch:8001/cedardoc/info?document_id=320873&version=1)
- 8-9 B. Gorini, ROS Software Architecture Document, <https://edms.cern.ch/document/384343/1.3>
- 8-10 ReadOut Subsystem, Summary of prototype Roblins, <https://edms.cern.ch/document/382933/1>
- 8-11 Readout sub-system test report (using DAQ-1), in preparation.
- 8-12 R.Cranfield et al., ROS Requirements, <https://edms.cern.ch/document/356336/1.0.0>
- 8-13 B. Green et al., Roblin TDR-Prototype HLDD, <https://edms.cern.ch/document/356324/2.4>
- 8-14 B. Green et al., Roblin TDR-Prototype DLDD, <https://edms.cern.ch/document/356328/2.3>
- 8-15 B. Green et al., Roblin TDR-Prototype Software Interface, <https://edms.cern.ch/document/356332/2.2>
- 8-16 The MPRA GE board, <http://mp-pc53.informatik.uni-mannheim.de/fpga/>
- 8-17 Gigabit Ethernet testes XXX
- 8-18 B. Gorini et al., ROS Test Report, in preparation.
- 8-19 P. Werner and A. Boggaerts, Pseudo-ROS Requirements, <http://atlas.web.cern.ch/Atlas/GROUPS/DAQTRIG/DataFlow/DataCollection/docs/DC-012/DC-034.pdf>
- 8-20 P. Werner, Pseudo-ROS Design Document, <http://atlas.web.cern.ch/Atlas/GROUPS/DAQTRIG/DataFlow/DataCollection/docs/DC-012/DC-041.pdf>
- 8-21 ROD Crate DAQ Task Force, Data Acquisition for the ATLAS ReadOut Driver Crate (ROD Crate DAQ), <https://edms.cern.ch/document/344713/1>
- 8-22 R. Spiwoeks, Workplan for ROD Crate DAQ, <https://edms.cern.ch/document/384357/1>
- 8-23 M.Abolins et al., Specification of the LV11 / LV12 trigger interface, <https://edms.cern.ch/document/107485/1>

- 8-24 R. Blair et al., A Prototype Rol Builder for the Second Level Trigger of ATLAS Implemented in FPGA's, ATL-DAQ-99-016
- 8-25 B.M. Barnett et al., Dataflow integration of the calorimeter trigger CPROD with the Rol Builder and the ROS, <https://edms.cern.ch/document/326682/1>
- 8-26 H-P Beck and C. Haebberli, Message Flow: High-Level Description, <http://atlas.web.cern.ch/Atlas/GROUPS/DAQTRIG/DataFlow/DataCollection/docs/DC-012/DC-012.pdf>
- 8-27 H-P Beck and F. Wickens, Message Format, <http://atlas.web.cern.ch/Atlas/GROUPS/DAQTRIG/DataFlow/DataCollection/docs/DC-012/DC-022.pdf>
- 8-28 M. Giobataru and S. Stancu, Networking Tests, in preparation.
- 8-29 Networking group activity, in preparation.
- 8-30 R. Hauser and H-P Beck, Requirements for the Message Passing Layer, <http://atlas.web.cern.ch/Atlas/GROUPS/DAQTRIG/DataFlow/DataCollection/docs/DC-012/DC-008.pdf>
- 8-31 R. Hauser, Message Passing Interface in the LV12 Reference Software, <http://atlas.web.cern.ch/Atlas/GROUPS/DAQTRIG/DataFlow/DataCollection/docs/DC-012/DC-007.pdf>
- 8-32 P. Golonka, Linux network performance study for the ATLAS DataFlow System, <https://edms.cern.ch/document/368844/0.50>
- 8-33 R. Hauser and H-P Beck, ATLAS TDAQ DataCollection Requirements, <http://atlas.web.cern.ch/Atlas/GROUPS/DAQTRIG/DataFlow/DataCollection/docs/DC-012/DC-045.pdf>
- 8-34 R. Hauser and H-P Beck, ATLAS TDAQ/DCS DataCollection Architectural Design, <http://atlas.web.cern.ch/Atlas/GROUPS/DAQTRIG/DataFlow/DataCollection/docs/DC-012/DC-043.pdf>
- 8-35 Y. Yasu et al., Summary of Studies on ATLAS DataCollection software with QoS, <https://edms.cern.ch/document/382921/1>
- 8-36 M. Gruwe & B. Di Girolamo, DataFlow performances measurements: the Event Building, <https://edms.cern.ch/document/375101/1>
- 8-37 C. Haebberli et al., ATLAS DataCollection: Event Building Test Report, <https://edms.cern.ch/document/382415/1>

## 9 High-level trigger

### 9.1 HLT overview

The High-level Trigger (HLT) contains the second and third stages of event selection. It comprises three main parts: The LVL2 system, the Event Filter (EF) and the Event Selection Software (ESS). Section 9.2 describes the components of the LVL2 system, Section 9.3 describes those for the EF and Section 9.4 describes the operation of the LVL2 and EF systems. Although the algorithms used at LVL2 and the EF are different, it has been decided to use a common software architecture for the event selection code across LVL2, EF and off-line studies. This facilitates use of common infrastructure (such as detector calibration and alignment data) and simplifies off-line studies and development of the HLT algorithms. The common ESS architecture is described in Section 9.5.

The basic structure of the HLT selection chain is shown in Figure 9-1 in a simplified form. The starting point for the HLT is the LVL1 Result. It contains the LVL1 trigger type and the information about primary Rols that caused the LVL1 accept, plus secondary Rols not used for the LVL1 accept. Both types of Rols are used to seed the LVL2 selection. The concept of seeded reconstruction is fundamental, particularly at LVL2 (apart from the special case of B-physics — see Section 13.4.5).

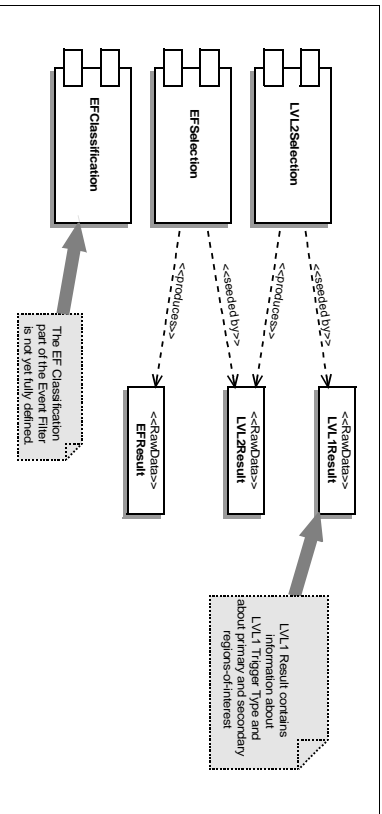

Figure 9-1 The high level trigger selection chain with the LVL2 and EF selection each seeded by the preceding trigger

The LVL2 Result provides a seed for the EF selection, thus playing a similar role for the EF as does the LVL1 Result for the LVL2. It will also be possible to seed the EF directly with the LVL1 Result in order to study for example the LVL2 performance. The EF and the LVL2 Results, containing the physics signatures from the trigger menu which were satisfied and higher level reconstruction objects, will be appended to the raw event data.

The EF classification is yet to be defined in detail. Possibilities considered include special selections for calibration events and for new physics signatures, i.e. a discovery stream. The EF Result can be used to assign tags to the events or even assign them to particular output streams.

The flow of data is as follows. Data for events accepted by the LVL1 trigger are sent from the detector front-end electronics to the ROSS, containing ~ 1600 ROBs. In parallel, information on the location of Rols identified by LVL1 is sent to the LVL2 Supervisor to guide the LVL2 event selection. Figure 9-2 shows the exchange of messages that are then used to perform the HLT process.

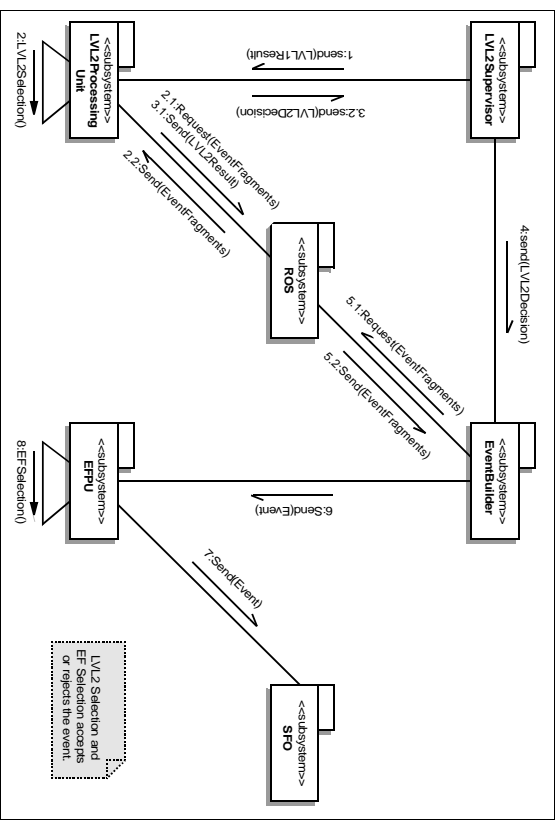

Figure 9-2 The exchange of messages between HLT Components

The LVL2 Supervisor sends the LVL1 Result to the L2PU, where the LVL2 selection is performed. Using the LVL1 Result as guidance specialised LVL2 algorithms request a sub-set of the event data from the ROSS to perform the event selection. In this way only a few percent of the event data need to be transferred to the LVL2 system — thus considerably reducing the network bandwidth required. For events accepted by LVL2 details are sent to the ROS (in the LVL2 Result) to be included in the event. The L2PU send the LVL2 Decision back to the LVL2 Supervisor, which forwards them to the Event Builder. Within the Event Builder the SFI assemblies each accepted event into a single record, including the LVL2 Result. The built event is then passed to the EFPU where off-line algorithms are applied guided by information from the LVL1 and LVL2 triggers to further refine the event selection. Events passing the EF are then passed to the SFO for permanent storage and off-line analysis.

Details of how the HLT system fits into the overall HLT/DAQ architecture have been given in Chapter 5.

## 9.2 LVL2

### 9.2.1 Overview

The LVL2 trigger provides the next stage of event selection after the hardware-based LVL1 trigger. It uses RoI guidance received from LVL1 to seed the validation and enhancement of the LVL1 trigger using selected full granularity event data. Components involved in the LVL2 process are the RoI Builder (RoIB), the LVL2 Supervisor (L2SV), the LVL2 Processors (L2P), the ROSS and the pROS. The RoIB assembles the fragments of information from the different parts of the LVL1 trigger and transmits the combined record to a L2SV. The L2SV selects a L2P for the event and sends the LVL1 information to that processor and then waits for the LVL2 Decision to be returned. The L2P runs the LVL2 selection code, requesting event data as required from the ROSS and returns the LVL2 Decision to the L2SV. For events which are to be passed to the EF the L2P also sends a more detailed LVL2 Result to the pROS to be included in the event to be built. Details of the ROS and the DataFlow aspects of the gathering of data within an RoI for LVL2 are described in Chapter 8. Details specific to the LVL2 selection process of all of the other components are given below.

### 9.2.2 RoI Builder

For each LVL1 accept the various parts of the LVL1 trigger send information on the trigger including the RoI positions and thresholds passed. The RoIB combines these fragments into a single record which is passed to a L2SV. In the baseline design each L2SV will only see a sub-set of the L2Ps, thus the choice of L2SV affects the load-balancing between L2Ps. This routing would normally be on a round-robin basis, but busy L2SVs can be skipped and the design also allows more complex algorithms, including use of the LVL1 trigger type. A fuller description of the RoIB is given in Section 8.2.1.

### 9.2.3 LVL2 Supervisor

The LVL2 Supervisors (L2SV) are a small group of processors (of order 10) that supervise the flow of events in LVL2 and mediate between the LVL2 system and the LVL1 system. In order to simplify farm management and to keep software uniform the processors will be similar to those used in the LVL2 farm, however, each Supervisor processor needs an interface (S-LINK in the baseline architecture) to receive the data from the RoIB (see Section 8.2.1). The L2SV application is based on the DataCollection Framework described in Section 8.3.2.

The context of the L2SV is indicated in Figure 9-3. The L2SV receives information on the LVL1 trigger in a single record (LVL1Data) from the RoIB. It selects a L2P for the event and passes the LVL1 data to the L2PU (running in the L2P) in the LVL1Result message. Once the L2PU has decided whether the event should be accepted or rejected it passes back a LVL2Decision message. If the decision is an accept or if the L2SV has collected a predetermined number of rejects, the LVL2Decision Group message is sent to the DFM where the DFM coordinates clearing of the buffers and readout to the EB.

In selecting a L2P the Supervisor exercises a load balancing function. Currently the Supervisor is designed to either select L2Ps from its available pool via a simple round-robin algorithm or by examining the number of events queued and assigning the event to the least loaded process-

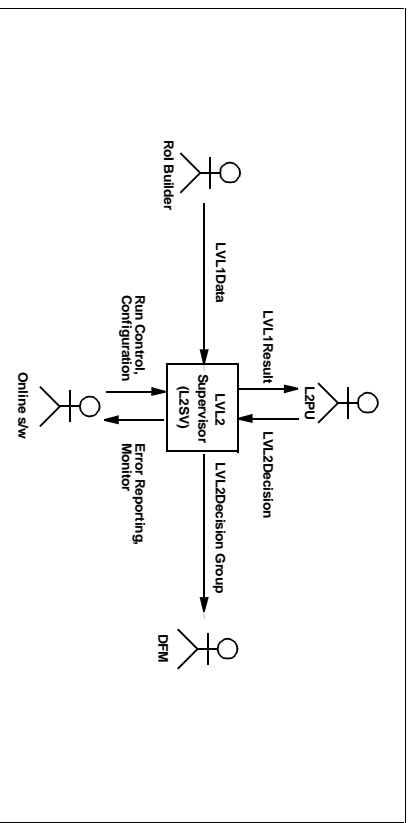

Figure 9-3 Context of LVL2 Supervisor

or. The L2SV can also use the LVL1 Trigger Type when selecting an L2P, this could be used to restrict specific triggers types to a sub-set of the L2P for example when debugging code for a new trigger. It is also foreseen to automatically accept certain classes of LVL1 triggers without involving the L2Ps, for example detector calibration events. This could be extended to provide unbiased samples to the EF.

The supervisor software is based on the DataCollection Framework described in Section 8.3.2. For normal data taking the LVL1Data is received from the RoIB, but for diagnostic purposes the Supervisor can also retrieve LVL1 data from a file or generate it internally.

For further details of the L2SVs see Section 8.3.1 and Section 8.3.2. Details of the Requirements and Design of the L2SV are given in [9-1] and [9-2] respectively.

### 9.2.4 LVL2 Processors

The LVL2 selection is performed in farm of processors, today assumed to be dual processor PCs, running at 8 GHz, in 1U rack-mounted format. The nominal budget allowed for the mean processing time for the LVL2 decision per event is ~ 10 ms. However, there will be large variations from event to event, many events will be rejected in a single selection step in a significantly shorter time than the mean, whilst others will require several sequential steps and a few events may take many times the mean latency. Each event is handled in a single processing node, requesting selected event data from the ROSS for each RoI only when required by the algorithms. To maintain a high efficiency of processor utilisation even when it is waiting for such RoI event data, several events are processed in parallel in each processing node.

The processing is performed in a single application running on each node (i.e. PC host). The application has three main components: the L2PU, the PESA Steering Controller (PSC), and the ESS. The L2PU handles the DataFlow with other parts of HLT/DAQ, including message passing, configuration, control and supervision. The PSC runs inside the L2PU and provides the required environment and services for the ESS. As the L2PU handles the communication with the L2SV and the ROSS, interfaces have to be provided for the various messages between the L2PU





event is built the pROS is included with all the other ROSs — thus including the LVL2 Result into the built event, which is passed to the EF. A single such unit is sufficient for the size of LVL2 Result foreseen (not exceeding a few kilobytes) as it only has to operate at the event building rate (~ 3 kHz). Further details of the pROS are given in Section 8.1.3.4.

### 9.3 Event Filter

The Event Filter (EF) is the third and last stage of the on-line selection chain. It makes use of the full event information. It will use the offline framework (Athena) and the Event Selection Software, that will execute filtering algorithms directly based on the offline reconstruction.

#### 9.3.1 Overview

The functionality of the EF has been logically distributed between two main entities:

- the Event Handler (EH) performs the activities related to event selection. This includes: the data flow, both between the main DAQ system and the EF, and internally between different parts of the EF; the framework to support various tasks including the Processing Tasks (PT) where the selection code runs.
- the EF Supervisor handles the control operations, in co-ordination with the overall TDAQ control system. Its responsibilities include the monitoring of the EF. For further details see Section 9.4 below.

The EF has been designed so that additional functions can be added without jeopardising the selection activity. Examples of such extra activities are the global monitoring of the detectors or tasks related to alignment and calibration.

As described in Chapter 5 the baseline architecture of the EF relies on commodity components, namely PCs linked by Ethernet networks. A detailed description of the baseline architecture for EF may be found in [9-11]. The EF Farm is organised in independent sub-farms, in the baseline each one connected to a different SFI. The possibility of dynamic routing between SFIs and sub-farms is also being considered. Several SFOs can be connected to a given sub-farm. A given SFO may be accessed by different sub-farms. The proposed layout is shown on Figure 9-8.

#### 9.3.2 Event Handler

##### 9.3.2.1 Overview

A detailed list of requirements for the EH, based on analysis of the external constraints and use cases, can be found in [9-12].

The EH receives events from the SFIs. The events are distributed to Processing Tasks which run the selection code. Information contained in the event header can be used to route events to specific PTs. Events selected for final storage will be sent to an SFO, which can be selected according to classifications made in the PT, thus providing the possibility of dedicated output streams. Information created during the selection process will be appended to the events sent to permanent storage.

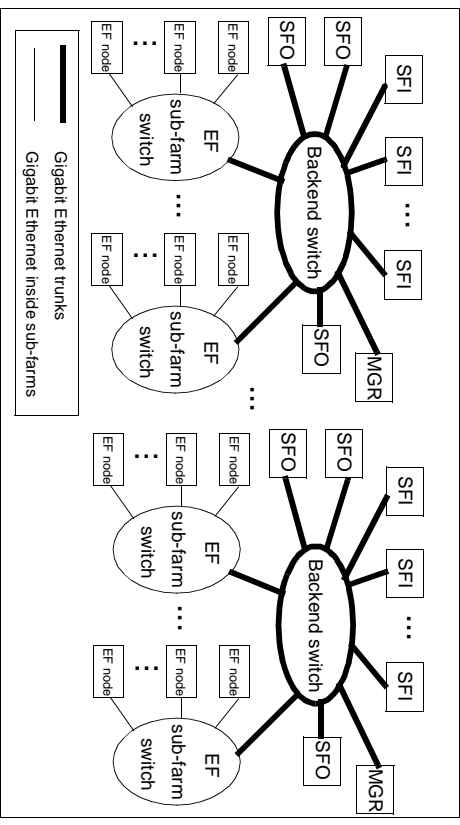

Figure 9-8 Proposed layout for the EF Farm

The design of the EH is based on the following principles: data flow and data processing are separated; the flow of events is data driven, i.e. there is no data flow manager to assign the event to a specified target; data copying on a given processing node is avoided as much as possible to save time and CPU resources.

Data movement between the different phases of the processing chain is provided by the Event Filter Dataflow process (EFD), while the processing is performed in independent Processing Tasks. There is one EFD process per processing node (i.e. per PC of the EF farms). One or several PTs can connect to the EFD at different stages of the processing chain. Event passing is made by a shared memory mapped file using a local disk for storage. Synchronisation is maintained via messages using UNIX sockets. Details can be found in [9-13] and [9-14].

##### 9.3.2.2 Event Filter Dataflow

The processing of the events is decomposed into steps which can be configured dynamically. Each step provides a basic function: event input or output, event sorting, event duplication, internal processing (e.g. for monitoring purposes), external processing, etc.

The different stages of the processing chain are implemented by 'tasks'. All 'tasks' are derived from a base class 'Task'. Each derived class is implemented to provide dedicated functionality. Example are: tasks providing the interface with the DAQ DataFlow; tasks to perform internal monitoring activity (e.g. counting the events which pass through); tasks to duplicate events to send them in parallel towards different processing paths; tasks to sort events towards different data paths according to internal flags (e.g. the result of the reconstruction and selection process); etc. However, functions such as the event selection (using the ESS) and pre- or post-processing are performed in separate processes and so tasks are included to provide the interface from the EFD process to these external Processing Tasks. An example of an EFD implementation, illustrating the use of these tasks, is given in Figure 9-9.



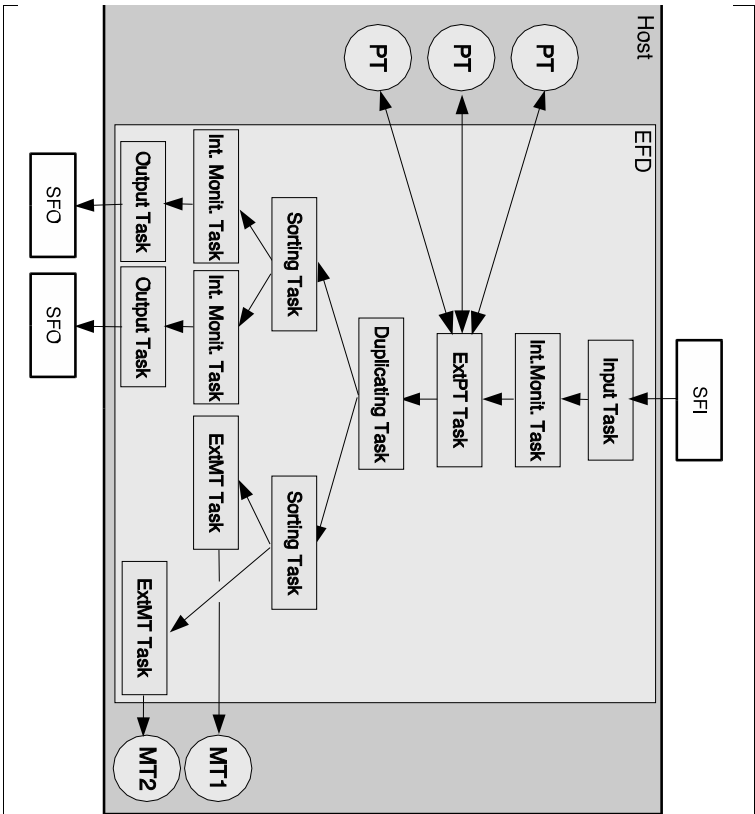

Figure 9-9 An example of an EFD implementation

In this example, an Input Task makes the interface with the SFI. Events are counted in an Internal Monitoring Task. The External PT Task provides the interface for synchronisation and communication with PTs performing the event selection. Events which are accepted by the PT are then duplicated. In one path, events are counted and passed to Output Tasks to be sent to permanent storage. In the other path, on which prescaling may be applied, events are made available to different monitoring tasks according to the tag they received during selection in the PT.

The InputTask maps events into shared memory (SharedHeap). For efficiency, event data is not copied between the processing steps, but pointers are passed to the different processing entities. The information produced by the external PTs can be made available to other (monitoring) tasks if it is stored in the SharedHeap. The file mapping the shared memory segment ensures that data is saved by the operating system in case of problems, e.g. a crash of the EFD process. It is the operating system which is in charge of saving the shared memory into the local disk where the segment is mapped. When the EFD is restarted, events received from the Data-Flow can be recovered from the SharedHeap. An automatic recovery procedure allows an event which has caused a crash of the PT to be reprocessed again. The PT crash is detected by

the socket hang-up, and the event is tagged as having been already processed. If the event causes a second crash it is sent to a dedicated output channel.

The tasks are daisy chained with each task knows the identity of the next task to execute for the current event. The Task base class has a method named `processEvent()` which receives a reference to an event pointer and returns a pointer to the next Task to be executed. The chaining mechanism is based on a WorkAssignment thread which first extracts an event from a Work Queue. Figure 9-10 shows the sequence diagram corresponding to this mechanism. The `getWork()` method returns an (Event pointer, Task pointer) pair from the Work queue. It then calls the `processEvent` method of the Task with the pointer to the Event. After processing, the method returns the pointer to the next Task, or the `NULL` pointer if it was the last task in the chain. This feature allows the dynamical configuration of the processing chain. New monitoring or diagnostic activities can easily be inserted into the flow of the event treatment.

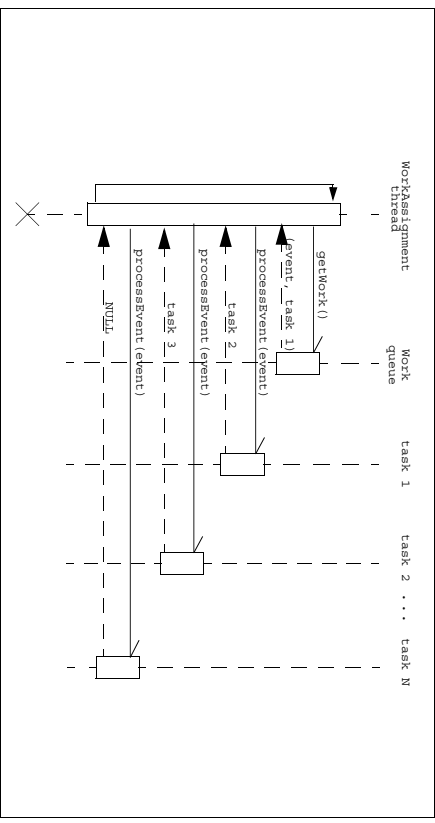

Figure 9-10 Sequence diagram for the work distribution in the EFD

### 9.3.2.3 Processing Task

Processing Tasks run on every processing node as independent processes. They use the offline framework Athena to run the Event Selection Software for the strategy described in Chapter 4. The sequence diagram shown in Figure 9-11 shows the synchronisation mechanism between the Event Selection Software and the framework provided by the Event Filter PT.

Event passing between PT and EFD is done via the SharedHeap described in the previous section. Synchronisation makes use of UNIX sockets. After having connected to the EFD process, the PT can request an event to the 'External PT Task'. It receives a pointer to a read-only region of the SharedHeap. When processing is completed, PT returns an 'EF answer' to the 'External PT Task' in EFD as a string. This EF answer is then used to decide which step will be executed next in the processing chain (event sent to permanent storage, deleted, used for monitoring purposes, etc.). PT can request a writable block in SharedHeap, where it can store additional information produced during processing. If the event is to be sent to permanent storage, EFD will append this data to the raw event.



The tests have been performed in Pavia on a cluster of dual Xeon (2.2 GHz) machines connected by Gigabit Ethernet and at CERN on a cluster of dual Pentium 3 (600 MHz) machines connected by Fast Ethernet. The results are summarised in Figure 9-13 and Figure 9-14.

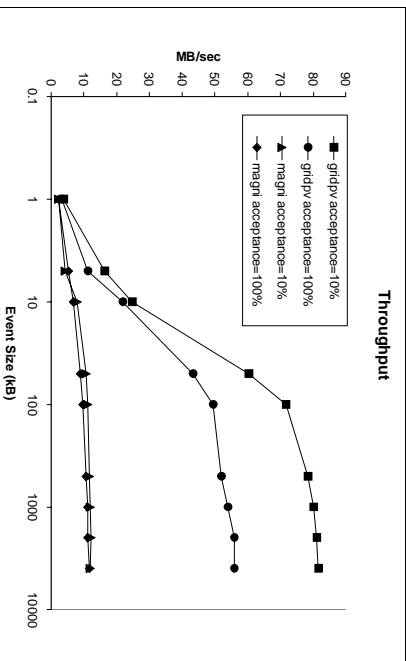

Figure 9-13 EFD throughput measurements (with processes running on different machines)

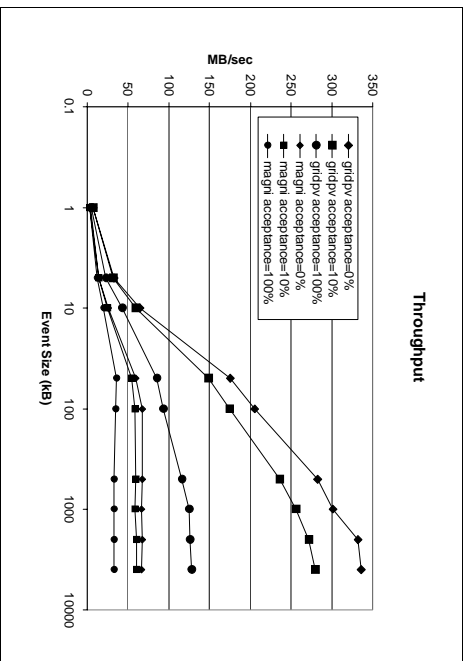

Figure 9-14 EFD throughput measurements (with processes running on different machines)

Conclusions ????

### 9.3.2.4.3 Robustness tests

To test the robustness of the EFD a configuration of an SFL, an SFO and the EFD, each on different machines of a 3 node cluster, was used. The processing node also included 4 PTs. The system was run for 10 days without problems and handled  $\sim 3 \times 10^9$  dummy events. The test included randomly stopping and starting some of the PTs, which the EFD handled correctly, stopping and resuming delivery of events to the corresponding PT as required.

## 9.4 HLT operation

### 9.4.1 Common aspects

The operational analysis of the whole HLT has been described in a dedicated document [9-17] which describes in details the expected functionality and gives uses cases for the operation. Use cases include: start-up, run control, shutdown, steady running and error conditions.

The HLT Supervision system is responsible for all aspects of software task management and control in the HLT. Mandates of the supervision system include: configuration of the HLT software processes, synchronizing the HLT processes with data-taking activities in the rest of the experiment, monitoring the status of HLT processes e.g. checking that they are running and re-starting crashed processes. The Supervision system must provide a user interface for the crew on shift. The interface must be as user friendly as possible while providing the tools for expert work during both the commissioning and steady operation phases. Both the LVL2 trigger and the EF are implemented as hundreds of software processes running on large processor farms, split for reasons of practicality into a number of sub-farms. In view of this the supervision requirements for the two systems are very similar and an integrated HLT supervision system has been developed. It has been implemented using services provided by the Online Software (see Chapter 10).

In addition to standard requirements on robustness and scalability, the design of the Supervision system must be sufficiently flexible to cope with future evolution during the lifetime of the experiment, especially when new hardware and software is used.

The Online Software configuration database is used to describe the HLT in terms of the software processes and hardware (processing nodes) of which it is comprised. The HLT supervision and control system uses information stored in the Online Software configuration database to determine which processes need to be started on which hardware and subsequently monitored and controlled. The smallest set of HLT elements, which can be configured and controlled independently from the rest of the TDAQ system is the sub-farm. This allows sub-farms to be dynamically included/excluded from partitions during data-taking.

Synchronization with the rest of the TDAQ system is achieved using the OnlineSW run control system. Each sub-farm has a local run controller, which will interface to the Online Software run control via a farm controller. The controller collaborates with a sub-farm supervisor, which provides process management and monitoring facilities within the sub-farm. The controller and supervisor cooperate to maintain the sub-farm in the best achievable state by keeping each other informed about changes in supervision or run-control state and by taking appropriate actions, e.g. restarting crashed processes. Where possible, errors should be handled internally within the

HLT processes. Only when they cannot be handled internally should errors be sent to the supervision and control system for further consideration.

The overall supervision of LVL2 and EF is integrated in the HLT Supervision system described in Section 12.3.2.

Software will also be required for farm management, i.e. hardware monitoring, operating system maintenance, code distribution on many different nodes, etc. However, given the commonalities with the requirements of many other farms and the increasing availability of such software elsewhere we plan to select the software to be used for this and how it is interfaced to the Supervision system at a later date.

#### 9.4.2 LVL2 operation

The configuration and control of the LVL2 applications in the LVL2 processors are handled by standard DataCollection controllers. The Run Control hierarchy consists of a root top level controller and one child controller per LVL2 sub-farm. It is convenient to configure the LVL2 Supervisors (which control the flow of events through the LVL2 farm - see Section 9.2.3) so that each LVL2 sub-farm is associated with just one LVL2 Supervisor - although a single Supervisor may send events to several sub-farms. Monitoring of the applications is performed in a parallel tree structure again with one monitor process per sub-farm. In contrast, however, for the Information Service a single IS server is used for all of the LVL2 processors.

#### 9.4.3 EF operation

A detailed list of EF requirements can be found in [9-18], many are common with LVL2 as listed above, however, some derive from remote EF sub-farms and the possibility of event monitoring and calibration tasks.

The EF Supervision also uses a tree-like structure following the baseline architecture described in Section 9.3.1. The Run Control hierarchy consists of a root top level controller and one child controller per sub-farm. All ancillary duties related to process management are performed by a supervisor server local to each sub-farm. A local Information Sharing server allows the exchange of information with other sub-systems.

#### 9.4.3.1 Scalability tests

Scalability and performance tests, in the context of EF Supervision, have been performed on the ASGAR cluster at ETH Zurich and on CERN-IT clusters. Detailed results are given in [9-19] and [9-20] respectively. On ASGAR, the supervision system had been implemented with JAVA Mobile Agents technology. It has been possible to control successfully 500 processors. However, the tested product, which was freeware, is now licensed and has therefore been discarded.

An implementation of the Supervision has been made using the tools provided by the Online Software group. This implementation has proved to be able to control some 1000 processors (running on 250 quad-board machines from the CERN-IT cluster). The execution times for the Run Control transitions do not depend strongly on the number of controlled nodes and are less than 3 seconds for configurations of a size varying between 50 and 250 nodes (See Section 10.6.2).

## 9.5 Event Selection Software (ESS)

The tasks of the Event Selection Software are 'event selection' and 'event classification'. Abstract objects representing candidates of e.g. electrons, jets, muons and  $J/\psi \rightarrow e^+e^-$ , are reconstructed from event data by using a particular set of HLT Algorithms and applying appropriate cuts. An event is selected if the reconstructed objects satisfy at least one of the physics Signatures given in the Trigger Menu. In both LVL2 and the EF events are rejected if they do not pass any of the specified selection criteria, which are designed to meet the signal efficiency and rate reduction targets of the trigger. From a physics event selection point on view there is no precise boundary between LVL2 and EF. Indeed, flexibility in setting the boundary is important to profit from the complementary features of these trigger stages.

The ESS comprises an infrastructure and the selection algorithms. The latter are to be provided either by the PESA group or, in case of the algorithms for the EF, by the offline reconstruction group. Major parts of the trigger reconstruction will have to be based on offline reconstruction algorithms. This is an important constraint for the design of the ESS.

In the HLT system the ESS will run in the software environments provided by the L2PU and by the PT of the EF, as shown in Figure 9-7 and Figure 9-12 respectively. Hence the ESS needs to comply with the online requirements, such as thread safety, online system requirements and services [9-6], as well as the online performance goals.

It is highly desirable though that the ESS is also able to run directly in the offline environment Athena [9-7] to facilitate development of algorithms, to study the boundary between LVL2 and EF, and to allow performance studies for physics analysis. Therefore the ESS needs to comply with the control framework and services that are provided by the offline software architecture. For this reason the Athena framework was chosen as the framework to run the ESS inside the EF PT and in the modified form provided by the PESA Steering Controller inside the L2PU (see Section 9.2.4.3 and Section 9.3.2.3 above).

In the offline, the task of the ESS is to emulate the full online selection chain. Hence three so called top level Athena algorithms are required, namely the emulation of the LVL1 trigger and two instances of the Event Selection Software. The LVL1 trigger emulation provides the LVL1 Result. The first instance of the Event Selection Software is configured to execute the LVL2 seeded by the LVL1 Result, the second to execute the EF selection seeded by the LVL2 Result. The details of the prototype implementation of the physics selection chain is given in Chapter 13.

#### 9.5.1 Overview

The design and implementation of the Event Selection Software is based on the requirements and use cases documented in reference [9-21]. The current prototype implementation follows the analysis and conceptual design discussed in reference [9-22]. In the following an overview of the subsystem is given and the design and implementation of the basic concepts are discussed.

The ESS is subdivided into four sub-packages, as listed below. These are shown in Figure 9-15 with the most important external software dependencies.

- The **Steering** controls the selection software. It organises the HLT Algorithm processing in the correct order, so that the required data is produced and the trigger decision is obtained. The Steering implements the interface to the PESA steering controller (when run-

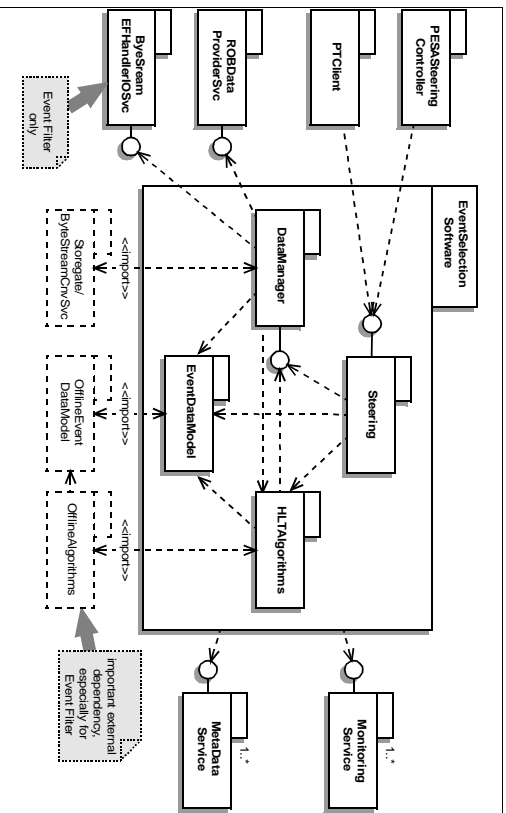

**Figure 9-15** A package diagram of the Event Selection Software. Also shown are the dependencies of the sub-packages. The dependencies on the offline Event Data Model and on the offline algorithms are explained in the text.

- The event data is structured following the **Event Data Model (EDM)**. The EDM covers all data entities in the event and the relationships between them. The data entities span from the raw data in byte stream format (originating from the detector RODS), the LVL1 Result and all other reconstruction entities up to the LVL2 and EF Results.
- The **HLT Algorithms** are used by the Steering to process the event and to obtain the data on the basis of which the trigger decision is taken.
- The **Data Manager** handles all event data during the trigger processing. The current implementation is based on Athena Storage [9-23] to provide the necessary infrastructure for the EDM. The offline Byte Stream Conversion Service is used to implement the HLT Algorithm access to the raw data. Different implementations of the ROB Data Provider Service are used for the LVL2, EF and offline to access the ROB Fragments.

In summary, the EDM covers all event data entities and is used by the Steering, the HLT Algorithms and the Data Manager to communicate information about the event. The HLT Algorithms build up the event tree in the process of the reconstruction. The result is analysed by the Steering to obtain the trigger decision. The Data Manager supports the EDM. It provides the means of accessing the event data and for developing it as the event is processed. The data access patterns reflect the needs of the HLT Algorithms and of the Steering, and the constraints of the online systems. Raw data access by 'Region' is a requirement, especially for the LVL2. In the following subsections more details are given of the Event Selection Software sub-packages.

### 9.5.2 The Event Data Model sub-package

The LVL2 and the EF selection are implemented as software triggers that select events by means of reconstruction, guided by the ROI information provided by the LVL1 system. Therefore the organisation of the data classes and of the object relations are fundamental. The EDM of the Event Selection Software is closely coupled to the offline EDM, especially because offline algorithms are the basis of the EF selection. The EDM is therefore being developed in close contact with the offline EDM, detector and reconstruction groups. Logically the EDM classes are grouped into 5 sub-packages:

- **Raw Data** coming from the ROS and the trigger systems are in byte stream format. This includes the LVL1 Result, the LVL2 and EF Results, as well as ROB Data from the sub-detectors and from the LVL1 system. Note that for a given sub-detector several Raw Data formats might be used, e.g. different formats depending on the luminosity. This includes different data content or compression schemes.
- The **Raw Data Objects (RDO)** are an object representation of the raw data from the different sub-detectors. In the trigger they are only used in the EF where they are created at input to the reconstruction chain. In LVL2, however, creating these objects poses too much overhead and thus in LVL2 the Raw Data is converted directly to Reconstruction Input Objects (RIOs) described below.

**Features** are all types of reconstruction data derived from the RDOs or from other features, with increasing levels of abstraction. This includes all offline reconstruction EDM classes. They range from relatively simple RIOs (e.g. calibrated calorimeter cells and SCT clusters) up to reconstructed quantities such as Tracks, Vertices, Electrons or Jets.

A detailed description of the implementation of the Raw Data formats, RDOs and features for the current prototype are given in Section 13.3 and the associated references.

- **MC Truth** information. Together with the first three sub-packages of the EDM, the Monte Carlo truth is common to the Event Selection Software and the offline reconstruction. It is needed primarily for debugging and performance studies.
- **Trigger Related Data** comprising ROI Objects, the LVL1(LVL2/EF) Trigger Type [9-24], Trigger Elements (TEs) and Signatures. A TE labels a set of Features and associates them with a physical interpretation, such as a particle, missing energy or a jet. TEs are the objects used by the Steering to guide the processing and to extract the trigger decision.

An important aspect of the EDM is the ability to navigate between different objects in the event using the relations between them. This is used during the HLT Algorithm processing to analyse and develop the knowledge of the event. Examples of instances of EDM classes and their relations are discussed in Section 9.5.3.1 in the context of the Seeding Mechanism.

### 9.5.3 The HLT algorithms sub-package

The task of the HLT Algorithms is to analyse the Raw Data and to reconstruct parts of the event according to the guidance from LVL1. This reconstructed data is used by the Steering to derive the trigger decision. The LVL1 ROI based approach implies a data driven event reconstruction. Any HLT Algorithm in a reconstruction sequence may be executed several times per event, once for each ROI. Therefore a modular architecture of the reconstruction code is necessary. The HLT Algorithms are structured into three parts:

- **Data Preparation** comprises algorithmic code to convert the Raw Data into objects that are used as input to reconstruction, include format changes and calibration corrections. This task involves sub-detector specific information, and hence sub-detector groups are responsible for the implementation and maintenance of the code, taking the HLT requirements into account. In the current design the organisation of the Data Preparation is different for LVL2 and the EF. The EF follows closely the offline reconstruction chain, where the Raw Data is first converted into RDOs and these are subsequently processed to obtain SCT Clusters or Calorimeter Cells. In LVL2 the Data Preparation goes in one step from Raw Data to RDOs, thus avoiding the overhead of creating the RDOs.

The boundary between Data Preparation and subsequent Feature Extraction is not exact, but only Data Preparation algorithms use the Raw Data or Raw Data Objects.

- **Feature Extraction** algorithms operate on abstract Features and Trigger Related Data to refine the event information. Two types of algorithms are distinguished in the Feature extraction sub-package. **Reconstruction Algorithms** process Features and produce new types of Features, just like offline reconstruction algorithms. However, in the trigger, RO Objects are used to restrict the processing to geometrical regions of the detector. To do this TEs are used by the Steering to 'seed' the reconstruction algorithms. The Seeding Mechanism is discussed in the next subsection. The second type of algorithms are **Hypothesis Algorithms**. Their task is similar to particle identification. A hypothesis algorithm validates the physics interpretation implied by the label of the TE based on the reconstructed Features. An example is the validation of an 'electron' matching a reconstructed Calorimeter Cluster and a Track.
- A library of **Algorithm Tools** to carry out common tasks such as track-fitting or vertex-finding.

Overviews of Reconstruction Algorithms and Algorithm Tools implemented in the current ESS prototype are given in Section 13.3.3 and Section 13.3.4.

### 9.5.3.1 The seeding mechanism

Logically the trigger processing starts from a LVL1 RoI using predefined sequences of HLT Algorithms. A so called 'Seeding mechanism' is used to guide the reconstruction to those parts of the event relevant for preparing the trigger decision.

Figure 9-16 shows an example of the evolution of the tree of objects associated to one LVL1 RoI at different stages of the trigger processing. This example starts with an electro-magnetic RoI Object from the LVL1 calorimeter trigger. In the first step shown in Figure 9-16.a an input 'EM' TE which uses the RoI Object is created for the Steering.

Starting from the input TE the first HLT reconstruction step attempts to validate the physics hypothesis of there being an electromagnetic cluster above a certain threshold. For this hypothesis the Steering creates an output TE with the corresponding label. The output TE is linked to the input TE by a 'seeded by' relation. The Steering then executes the cluster finding HLT Algorithm, giving it the output TE as an argument, to validate this output TE. The algorithm navigates via the 'seeded by' and 'uses' relations from the output TE to the input TE and then to the 'LVL1EM' RoI Object to access information about the LVL1 RoI. The algorithm obtains  $\eta$  and  $\phi$  from the RoI and does its pattern recognition work. In the example it creates a Calorimeter Cluster from a set of Calorimeter Cells. These objects are linked to the output TE to record the event information associated with this RoI for later processing. Based on the reconstructed

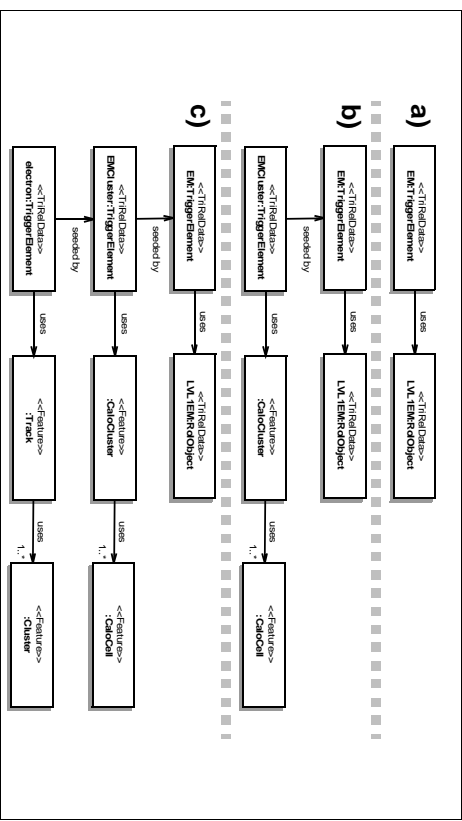

Figure 9-16 Three diagrams showing fragments of the object tree associated to one RoI at different stages of trigger processing. See text for details.

Cluster the algorithm validates the hypothesis if all cuts are passed. The algorithm transmits the result to the steering, by 'activating' the output TE in case of a positive decision. The Steering ignores all inactive TEs for further processing. The object tree at the end of the algorithm execution is shown in Figure 9-16.b

The next algorithm in the example looks for an electron track. It is seeded with a new output TE labelled 'electron'. The algorithm navigates the full tree of data objects to access the necessary information. To validate the 'electron' physics hypothesis it could use the precise position of the calorimeter cluster to reconstruct a Track from a set of SCT Clusters. If a Track is found the 'electron' hypothesis is validated and a TE is activated. The resulting object tree is shown in Figure 9-16.c.

The seeding mechanism needs to be general enough to cover all physics use cases. In Figure 9-17 a similar diagram to Figure 9-16.c is shown for the case of a LVL2 B-physics trigger. Here, the new aspect is the inner detector full scan. In this use case once the initial 'muon' has been validated a scan is made of the inner detector to reconstruct all tracks in the event. A TE 'uses' the collection of Tracks and seeds, for example, an algorithm that reconstructs an exclusive B-decay into two pions. The result of this would be a TE called 'B to PPi'. This TE uses a B-meson and is 'seeded by' the 'Inner Detector Scan' TE, as shown in the figure.

### 9.5.4 The steering sub-package

The Steering controls the HLT selection. It 'arranges' the HLT Algorithm processing for the event analysis in the correct order so that the required data is produced and the trigger decision is obtained. The Steering provides the interface to the PESA Steering Controller for running in the L2PU (Figure 9-6) and to the PT Client for running in the EF Processing Task (Figure 9-15). In the offline the Steering is a top level Athena algorithm executed directly by the Athena event loop manager.

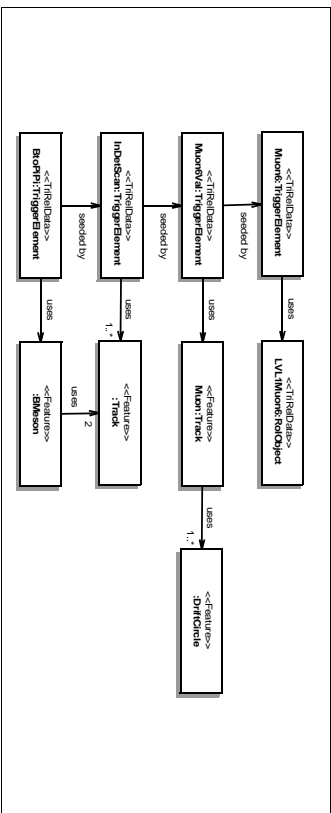

Figure 9-17 A diagram showing a fragment of the event for the case of LVL2 B-Physics trigger reconstruction. See text for details.

The LVL2 and the EF selection is data driven, in that it builds on the result of the preceding trigger level. The Steering has to guide the HLT Algorithm processing to the physics relevant aspects of the event. The Steering uses the Seeding Mechanism discussed in the previous section to restrict the reconstruction to the parts of the event corresponding to a given LVL1 Rol. Seen from the side of the Steering, the reconstruction of an event in the trigger is a process of refining TES, as was shown in Figure 9-16 and Figure 9-17.

The ESS has to implement the physics selection strategy discussed in Chapter 4. The HLT selection demands that an event matches at least one physics 'Signature'. Each Signature is a combination of abstract physical objects like 'electrons', 'muons', 'jets' or 'missing energy'. It is usually requested that, for example, an electron has a minimal energy and is isolated from a jet. Translated into the ESS a Signature is simply a combination of required Trigger Elements with labels like 'e25f'. An example for such a menu of Signatures is given in Table 4-1.

Many of the Signatures discussed in Chapter 4 require more than one TE. In this case it is beneficial not to complete the validation of the TES in turn, as a later one may fail at an early step of the validation. Thus the Steering arranges the HLT Algorithm processing in steps. At each step a part of the reconstruction chain is carried out, starting with the HLT Algorithm giving the biggest rejection. At the end of each step a decision is taken, whether the event can still possibly satisfy the TE combination required in the Signature. This concept of 'step processing' ensures the earliest possible rejection of events.

#### 9.5.4.1 Implementation of the steering

In Figure 9-18 a class diagram for the Steering sub-package is given. The **Step Controller** inherits from **AthenaAlgorithm** and is the interface to the PESA Steering Controller and the PT Client. It provides the necessary methods to configure the ESS at the beginning of a 'RUN', to execute the LVL2 or EF selection on an event, and to end a 'RUN'.

The task of the **Trigger Configuration** is to provide the Sequence and Menu Tables for the step processing. This task is carried out during the initialisation phase (before the start of a 'RUN'), which is especially important for LVL2.

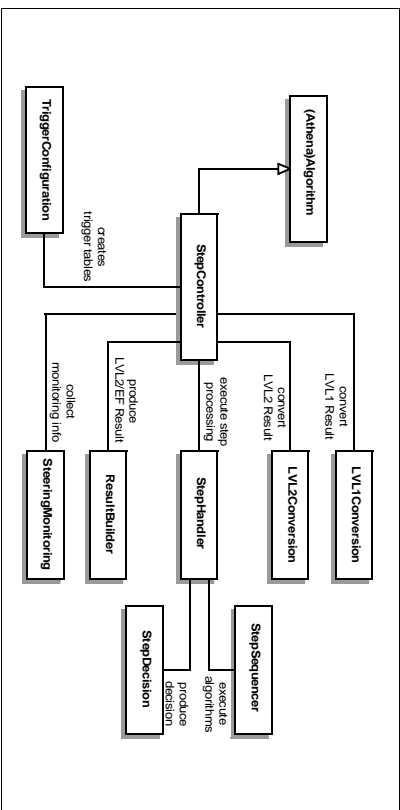

Figure 9-18 A class diagram for the Steering sub-package

In LVL2 the Step Controller uses the **LVL1 Conversion** for each event to convert the LVL1 Result (i.e. Raw Data) into Rol Objects and prepares the trigger selection by creating the TES needed for the Seeding Mechanism, as was shown in Figure 9-16.a. In the EF the corresponding **LVL2 Conversion** translates the LVL2 Result to prepare the EF selection.

The trigger processing of each event is performed by the **Step Handler**. For each step it uses the **Step Sequencer** to execute the HLT Algorithm from the corresponding Sequences. The Step Handler executes the **Step Decision** to compare the result of the algorithmic processing, given in terms of TES, with the Signatures to decide whether or not to reject the event. The Step Handler continues to process subsequent steps until the event is rejected or all steps have been executed. The **Result Builder** produces the LVL2 or EF Results, depending on which HLT subsystem the Event Selection Software is running.

The Step Controller uses the **Steering Monitoring** at the end of the event processing to collect summary information for monitoring purposes.

#### 9.5.4.2 The Trigger Configuration

At initialisation time the **Trigger Configuration** [9-25], [9-26] configures the ESS to execute the LVL2 or EF selection, depending on the subsystem the software is running in. The ATLAS trigger selection strategy is defined in terms of physics **Signatures** as given in Table 4-1. The **Trigger Configuration** derives the configuration of the selection from this list of physics Signatures and from the list of available HLT Algorithms that are implemented. A recursive algorithm is used that computes the full EF and LVL2 configuration in a top-down approach starting from the final Signatures. In this way a consistent configuration of both HLT selection levels is ensured which logically connects LVL2 and EF. The configuration scheme will be extended in the future to also cover the LVL1 configuration.

Technically the input to the **Trigger Configuration** are two XML files that are parsed [9-27] into C++ objects. The first XML file contains the list of final physics Signatures in terms of TE labels, as shown in Table 4-1. The second XML file contains a list of available Sequences of HLT Algorithms that can be used by the trigger. Each Sequence specifies the required input in terms of

TEs, the HLT Algorithms to be executed for these seeds and the hypothesis in terms of an output TE to be validated.

The recursive algorithm to calculate the full configuration is illustrated in Figure 9-19 using as

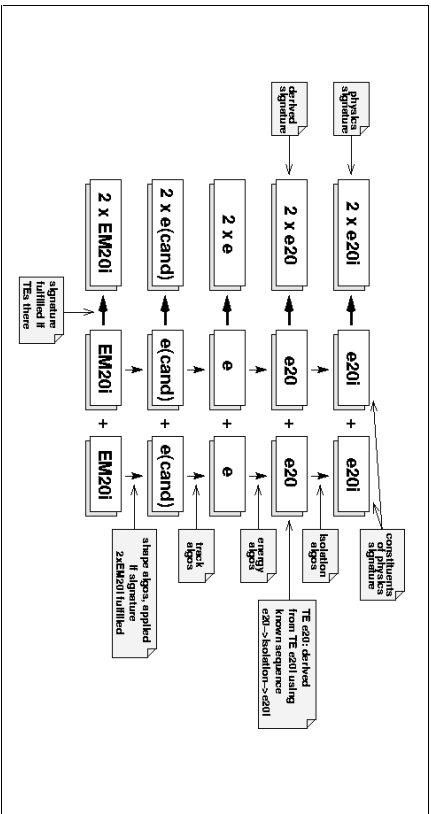

Figure 9-19 Illustration of the recursive configuration of the selection for a 2-electron trigger.

an example a '2-electron' Signature. The final physics Signature '2 x e201' requires two constituent TEs 'e201'. Such a TE is the output of a Sequence, which is found in the Sequence List. In the example the input TE of the matching Sequence is 'e20' and the Sequence contains an isolation algorithm. Hence, in order to satisfy the final Signature '2 x e201' requires two 'e20' TEs in the previous step or in other words, the derived Signature of '2 x e20'. The recursion is continued until the LVL1 input TEs are reached (corresponding to the Rol Objects as shown in Figure 9-16.a). In the example from Figure 9-19 this corresponds to 4 recursion steps.

The calculation is done for all final Signature in the full trigger menu and the resulting tables are combined for each trigger step. Different Signatures may involve the same Algorithm or Sequence in a given step. Hence the tables are processed to remove double entries. The boundary between LVL2 and EF is defined by associating Sequences in the input list to either of the two trigger levels. This association is the basis for separating the EF and LVL2 in the output of the Trigger Configuration. Prescaling and forced accept rates are allowed for at the level of the Signatures.

The output is given in the form of pairs of **Sequence Tables** and **Menu Tables** for each trigger step. The class diagram is shown in Figure 9-20. The tables contain the necessary information in terms of TEs and HLT Algorithms for the Steering to control the data driven trigger processing as discussed in the following subsections.

9.5.4.3 The LVL1 conversion

At the start of the LVL2 event processing the LVL1 Result is converted into a form that is suitable for steering the step processing. The Step Controller calls the LVL1 Conversion to decode the

TEs, the HLT Algorithms to be executed for these seeds and the hypothesis in terms of an output TE to be validated.

The recursive algorithm to calculate the full configuration is illustrated in Figure 9-19 using as

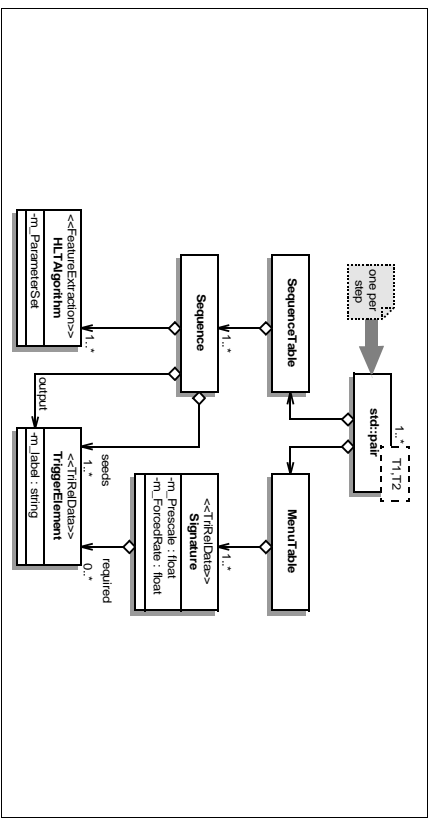

Figure 9-20 A class diagram for output of the Trigger Configuration, showing for each step a pair of a Sequence Table and a Menu Table

LVL1 Result fragment (the output of the RolB, see Section 13.2). In the fragment the Rol information is encoded into 32 bit words as defined in [9-24]. These words contain bit patterns identifying, for example, the electronics channel from which the Rol came and the threshold passed. This information is uniquely related to the location of the Rol in  $\eta$ - $\phi$  space and to the threshold value in GeV. To obtain the values it is required to use the configuration of the LVL1 and sub-detector specific mapping information. The Rol Objects are then stored for further processing and for each Rol Object a TE of the corresponding label is created to enable the Seeding Mechanism as shown in Figure 9-16a.

9.5.4.4 The Step Handler

After the LVL1 Conversion (or in the EF the LVL2 Conversion) the Step Controller executes the Step Handler. In Figure 9-21 a sequence diagram is shown for the step by step processing of an event by the Step Handler. Each step is configured by a pair of a Sequence Table and a Menu Table, as provided from the Trigger Configuration.

The Step Handler first executes the Step Sequencer, which controls the reconstruction part of each step. The Step Sequencer accesses the list of active input TEs from the previous step or the LVL1 Conversion for the first step. The list is compared to the required input TEs of each Sequence in the Sequence Table. For all matching combination of TEs the Step Controller executes the HLT Algorithms in the corresponding Sequence. To implement the Seeding Mechanism discussed in Section 9.5.3.1 it is necessary to create the output TE and the 'seeded by' relation to the input TE and then pass the output TE as a seed to the HLT Algorithm, as shown in Figure 9-21. The HLT Algorithm has to validate the hypothesis of just this output TE. In the scheme currently implemented the HLT Algorithm signals a 'validated hypothesis by activating' the output TE. It is important to note that for a given event the same algorithm Sequences can be executed multiple times, but on different seeds, depending on the number of matching input TE combinations.



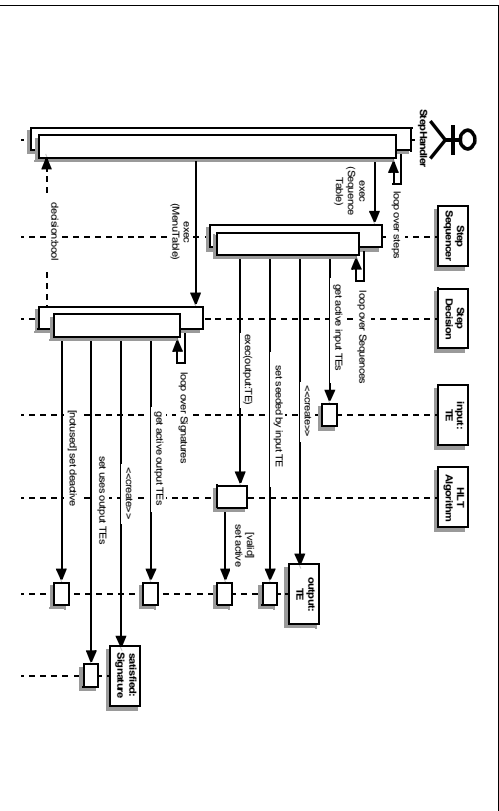

Figure 9-21 A sequence diagram for the Step Handler processing an event. For each step the Step Sequencer and the Step Decision are executed. No interaction with the store, etc., are shown. See text for details.

At the end of each step the Step Decision is run to decide, based on the result of the Step Sequencer, whether the event is still accepted. The Step Decision compares the list of active output TESs to the required TE combinations for the Signatures in the Menu Table of the step. For each matching TE combination the Step Decision creates a satisfied Signature object that 'uses' these TESs. In the next step only those TESs that were used to satisfy a least one Signature are used for further processing, all others are discarded from the event by deactivating them. An event is accepted for the step if at least one Signature was satisfied. The Step Handler continues processing the next step either until the event is rejected by the Step Decision or until all steps are done, in which case the event is finally selected.

### 9.5.4.5 The Result Builder and the LVL2 Conversion

At the end of the LVL2 processing of an event, if the event was selected, the Result Builder provides the information to seed the EF selection. In the current implementation this includes information about all satisfied Signatures, the associated TESs and LVL1 RoIs. These are converted into a ROB fragment to be transferred via the pROS to the Event Builder. The structure is kept modular to accommodate a variable number of accepted items and to allow changes.

At the beginning of the EF processing the Step Controller executes the LVL2 Conversion that retrieves the LVL2 Result. It extracts the TE and Roi words to recreate the objects, including the navigational links among them. Thereby it recreates a structure similar to that shown in Figure 9-16.a as output of the LVL1 Conversion at the beginning of LVL2. The differences are that the TESs are the active TESs of the final LVL2 step and the list of LVL1 RoIs is reduced to the ones 'used' in the final decision. After the LVL2 Conversion the EF selection is controlled (and seeded) by the Step Handler in the same way as for LVL2, but using more sophisticated HLT Algorithms.

### 9.5.4.6 The Steering Monitoring

Monitoring of the Steering has several aspects, the debug output of the HLT Algorithms, the timing, the rate monitoring, etc. Monitoring Services are used by the Event Selection Software to publish this information. The Steering Monitoring runs at the end of the event and analyses the event in memory.

### 9.5.5 The Data Manager sub-package

The Data Manager sub-package provides the infrastructure to receive, store and later access data while processing the event. The transient data store, which is used to implement the Event Data Model, is thus the central part of this sub-package. The Data Manager also provides the means for the Event Selection Software to implement the Seeding Mechanism and to access Raw Data in restricted geometrical Regions (retrieve by Region). The Data Manager is the part of the ESS that is interfaced to the ROB Data Provider, as was shown in Figure 9-7 and Figure 9-12 for the L2PU and for the EF Processing Task, respectively.

### 9.5.5.1 Implementation

**Storegate** [9-23] is the part of the Athena infrastructure which provides the transient data store. It was originally designed to handle data for the offline reconstruction and analysis. Storegate provides services for the client application, such as the functionality of a container with infrastructure for data storage, different patterns of data access and memory management. It is also the part of Athena that supports persistency and implements the interface to the different IO services. Using the Storegate interface for the implementation of the Data Manager facilitates the use of offline software in the trigger. Initial timing measurements [9-10] have shown that the performance of Storegate's core services satisfies the EF and also the LVL2 requirements. Thus Storegate has been chosen to implement the Data Manager in the ESS. This choice allows for common interfaces for the HLT Algorithm to access the data when running online in the trigger or offline for development purposes, as will be discussed in the following.

Figure 9-22 shows the main components of the Data Manager:

- **Storegate**, as the transient data store, holds the event data during the processing.
- A **Region Selector** that provides an efficient look up of the Hash Identifiers of all Collections of data that fall within a given geometrical Region of a sub-detector. A Region is typically defined in terms of  $\eta$  and  $\phi$  by the Roi Objects provided by the LVL1 system.
- A **Detector Container** with RDO or RIO Collections for each sub-detector. The granularity of the Collections are optimized for the HLT Algorithm processing. For example, a Collection for the Pixel Detector contains the RDOs or RIOs (Clusters) in a Detector Element, in this case a module. For the LAr a Collection contains all cells in a sampling of a trigger tower. An HLT Algorithm retrieves each required Collection from the Detector Container using a Hash Identifier.
- The **Byte Stream Conversion Service** that provides the means to access the ROB data, to convert it and to provide the Collections of data. The Byte Stream Conversion Service is based on the normal Storegate persistency mechanism [9-23], which is designed to retrieve collections of objects from a persistent data source, i.e. a file or database. In the trigger context, however, this source is replaced by the ROB Data Provider to access the ROB Fragments containing the detector information in serialised format. In LVL2 the ROB

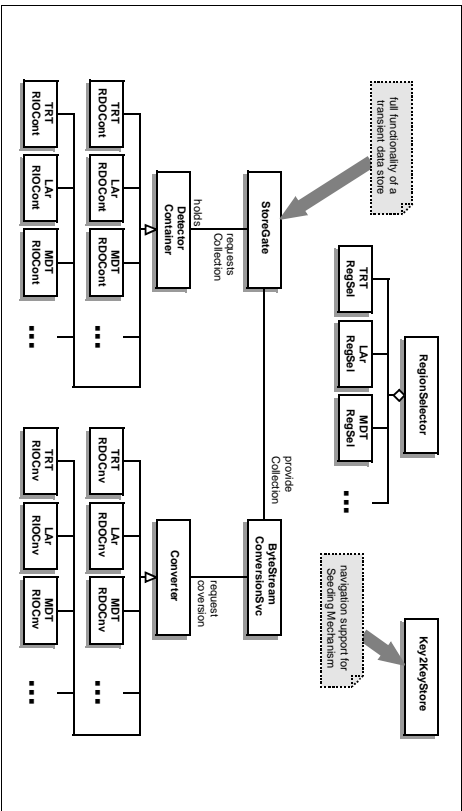

Figure 9-22 The class diagram for the Data Manager sub-package. See text for details.

Fragments have to be requested across the network and in the EF they are retrieved from the complete byte-stream event in memory.

- The **Converter** uses Data Preparation algorithms (as discussed in Chapter 9.5.3) to convert the Raw Data of the ROB Fragment into objects to be analysed by the HLT Algorithms. The Converters are specific to the detector and the type of data (RDOs for EF or RIOs for LVL2) requested by the HLT Algorithm.
- The **Key to Key Store** is a trigger specific implementation of the object relations that are used for the Seeding Mechanism (Chapter 9.5.3.1). It supports the 'seeded by' and 'uses' relations of Trigger Elements, Rol Objects and other EDM information in a generic C++ way that is also compatible with Storegate.

### 9.5.5.2 The Raw Data Access

The HLT Raw Data access follows the so-called 'London Scheme' [9-30], which uses the components described above. This scheme aims: to keep data transfers and CPU time to a minimum by only requesting and unpacking data as it is required; to encapsulate data access so that the algorithm does not have to deal with details such as the byte stream or ROB granularity; and so that the data source can be changed (LVL2, EF, off-line emulation) with no impact on the algorithm. A sequence diagram of the London Scheme is shown in Figure 9-23. The HLT Algorithm defines the geometrical Region from which it needs data. Typically the HLT Algorithm uses the position of the LVL Rol and defines a Region in terms of  $\delta\eta$  and  $\delta\phi$  around it. The geometrical Region is a general concept and is not confined to the original Rol information from LVL1, for example, during the HLT Algorithm processing as more refined information becomes available it may be possible to use a more refined volume (e.g. allowing for track curvature) thereby reducing the amount of data to be analysed. The Region Selector [9-28] translates this abstract Region into a list of Hash Identifiers to be used by the HLT Algorithm to access the Collections of RDO or RIO data. In the basic London Scheme the Region Selector merely returns the list of Hash Identifiers. However, for efficiency in the LVL2 environment the Region Selector also pro-

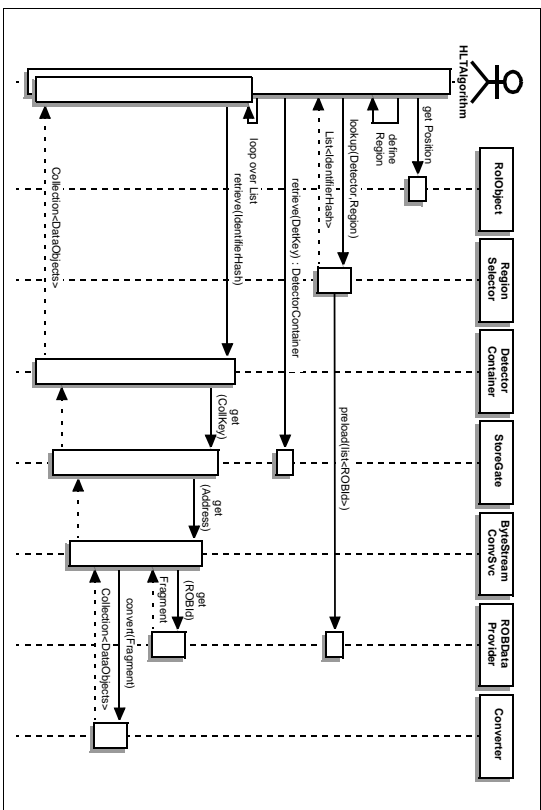

Figure 9-23 A sequence diagram showing the so-called 'London Scheme' for the data access. See text for details.

vides the list of ROB Fragments to be preloaded from the ROS via the ROB Data Provider. The ROB Data Provider caches the returned ROB fragments for later decoding. This optimization significantly reduces the network latency for ROB data access in LVL2 (see Section 14.2.1).

Having received the list of Hash Identifiers from the Region Selector, the HLT Algorithm retrieves the Detector Container for the type of data it requires (for details see [9-29]). In the current prototype the EF requests RDO data and uses the full offline Data Preparation algorithms to obtain the RIO information. The LVL2 directly requests the RIO data in order to avoid the overhead of RDO creation. During the reconstruction process the HLT Algorithm loops over the list requesting the individual Collections from the Detector Container. The Detector Container translates the Hash Identifier into an Address of the Collection in Storegate. In the normal case the Collection is not available and hence Storegate requests via its persistency mechanism the Byte Stream Conversion Service to provide the Collection. The Service retrieves the corresponding ROB fragment from the ROB Data Provider and uses either the RDO or RIO Converter to convert the data. The Collection is then stored in Storegate for possible subsequent requests and returned to the HLT Algorithm. In practice a ROB fragment contains the data for more than one Collection. It is a matter of optimization either to decode only the requested part or to fully prepare the data of all collections in the first request.

It should be noted that in this scheme the encapsulation in the Region Selector of the translation from an abstract region to the detector identifiers hides the details of the detector geometry from the HLT algorithms. The Storegate persistency mechanism hides the details of the online Raw Data. Thus the scheme provides the means to use offline code in the trigger and to use and develop dedicated LVL2 algorithms in the offline environment.

## 9.6 Conclusions

This chapter has described the components used in the HLT event selection, with the main emphasis on functional aspects and implementation. Some performance figures have been given for software components within the processors (the L2P and the EFP), but the overall system performance is largely determined by aspects outside of the scope of this chapter. For LVL2 a major requirement has been achieving adequate performance for RoI Collection, results for this (both for a single L2P and for possible scaling problems as more L2Ps and Event building are added) have been presented in Chapter 8 and indicate that this can be done using only a small part of the total LVL2 time budget. For the EF the movement of events through the system has also been demonstrated with performance well within the limits required. However, the validation of the overall architecture also requires that realistic algorithms, including data conversion from realistic input data, can be supported with adequate performance in the software framework described. The algorithms being developed for HLT and their current performances, are described in Chapter 13. System tests of both LVL2 and the EF are described in Chapter 14.

## 9.7 References

- 9-1 J.Schlereth and M. LeVine, LVL2 Supervisor Requirements, <https://edms.cern.ch/document/391501>
- 9-2 J.Schlereth, LVL2 Supervisor Design, <https://edms.cern.ch/document/391581>
- 9-3 C. Hinkelbein et al., Prospects of FPGAs for the ATLAS LVL2 Trigger, ATLAS Internal Note, ATL-DAQ-2000-006 (2000)
- 9-4 A.Khomich et al., Timing measurements of some tracking algorithm and suitability of FPGAs to improve the execution speed, ATLAS Internal Note, ATL-COM-DAQ-2003-006 (2003)
- 9-5 A.Boegaerts et al., LVL2 Processing Unit Application Design, <https://edms.cern.ch/document/391554>
- 9-6 A. dos Anjos et al., Guidelines for offline preparation and testing of LVL2 code, <http://www.cern.ch/steve.armstrong/algorithms/guidelines>
- 9-7 Athena: User Guide and Tutorial, <http://atlas.web.ch/Atlas/GROUPS/SOFTWARE/OO/architecture/General/Tech.Doc/Manual/2.0.0-Draft/AthenaUserGuide.pdf>
- 9-8 Gaudi, <http://cern.ch/proj-gaudi>
- 9-9 S. Gonzalez et al., Use of Gaudi in the LVL2 Trigger: The Steering Controller, <https://edms.cern.ch/document/371778/1>
- 9-10 A. Bogaerts et al., Initial LVL2 Tests with the Si Tree Algorithm, <https://edms.cern.ch/document/375305/1>
- 9-11 HP Beck et al., ATLAS TDAQ, a network-based architecture, TDAQ Data Collection note 59, <http://atlas.web.cern.ch/Atlas/GROUPS/DAQTRIG/DataFlow/DataCollection/docs/DC-059/DC-059.pdf>
- 9-12 C. Bee et al., Event Handler Requirements, <https://edms.cern.ch/document/361786/1>

- 9-13 C. Meessen et al., Event Handler Functional Design Analysis, <http://alashinfo.cern.ch/Atlas/GROUPS/DAQTRIG/EF/EFD-FunctionalAnalysis.pdf>
- 9-14 C. Bee et al., Event Handler Design, <https://edms.cern.ch/document/367089/1.1>
- 9-15 A. dos Anjos et al., Event Format Library Requirements, <https://edms.cern.ch/document/383859/1>
- 9-16 F. Touchard et al., Event Filter infrastructure validation tests, <https://edms.cern.ch/document/391248/1>
- 9-17 F. Touchard et al., HLT operational analysis and requirements to other sub-systems, <https://edms.cern.ch/document/363032/1>
- 9-18 C. Bee et al., Supervisor requirements, <https://edms.cern.ch/document/361792/1.1>
- 9-19 C. Bee et al., ATLAS Event Filter: Test Results for the Supervisor Scalability at ETH Zurich, ATLAS Internal Note, ATL-DAQ-2002-006 (2001)
- 9-20 S. Wheeler et al., Test results for the EF Supervisor, <https://edms.cern.ch/document/374118/1>
- 9-21 S. George et al., PESA high level trigger selection software requirements, ATLAS Internal Note, ATL-DAQ-2001-005 (2001)
- 9-22 M.Eising et al., Analysis and Conceptual Design of the HLT Selection Software, ATLAS Internal Note, ATL-DAQ-2002-013 (2002)
- 9-23 P. Calafiura et al., Storage: a Data Model for the ATLAS Software Architecture, <http://atlas.web.ch/Atlas/GROUPS/SOFTWARE/OO/architecture/EventDataModel/Tech.Doc/StoreGate/Chexp01.pdf>
- 9-24 M. Abolins et al., Specification of the LVL1/LVL2 Trigger Interface, <https://edms.cern.ch/document/107485/1>
- 9-25 T. Schoener-Sadenius, TrigConfig: The HLT configuration package, ATLAS Internal Note, ATL-COM-DAQ-2002-0019 (2002)
- 9-26 M. Eising and T. Schoener-Sadenius, Configuration of the ATLAS Trigger System, paper submitted to the proceedings of CHEP 2003, San Diego
- 9-27 Xerces: XML parser in C++, <http://xml.apache.org/xerces-c/index.html>
- 9-28 A.G. Mello, S. Armstrong, and S. Brandt, Region-of-Interest Selection for ATLAS High Level Trigger and Offline Software Environments, ATLAS Internal Note, ATLAS-COM-DAQ-2003-005 (2003)
- 9-29 S. Armstrong et al., Algorithms for the ATLAS High Level Trigger, <http://sarnstro.home.cern.ch/sarnstro/algorithms/doccps>
- 9-30 S. George et al., Design of the PESA core software Data Manager, <https://edms.cern.ch/document/390533>

## 10 Online Software

### 10.1 Introduction

The Online Software encompasses the software to configure, control, and monitor the TDAQ system but excludes the management, processing, and transportation of physics data. It is a customizable framework which provides essentially the 'glue' that holds the various sub-systems together. It does not contain any elements that are detector specific as it is used by all the various configurations of the TDAQ and detector instrumentation. It co-operates with the other sub-systems and interfaces to the Detector Readout Crates, the Detector Control System, the LVL1 Trigger, the DataFlow, the High Level Trigger processor farms, the Offline Software, and to the human user as illustrated in Figure 10-1. It also provides the interface between the human user and the TDAQ system.

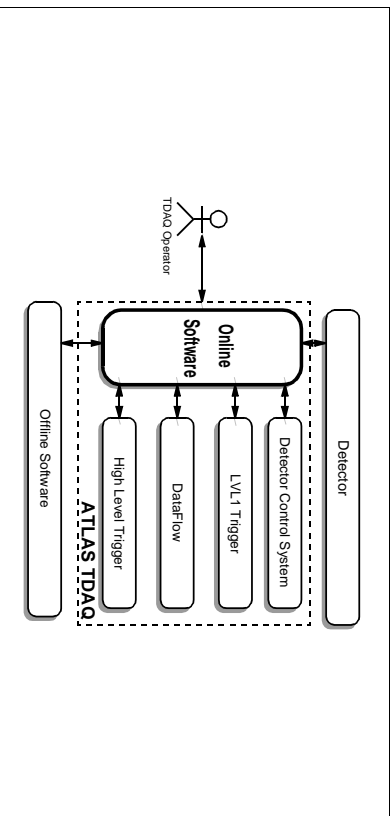

Figure 10-1 Context diagram of the Online Software

An important task of the Online Software is to provide services to marshal the TDAQ through its start-up and shutdown procedures so that they are performed in an orderly manner. It is responsible for the synchronization of the states of a run in the entire TDAQ system and for process supervision. These procedures are designed to take a minimum amount of time to execute in order to reduce the overhead, since this affects the total amount of data that can be taken during a data-taking period. Verification and diagnostic facilities help with early and efficient problem finding. Configuration database services are provided for holding the large number of parameters which describe the system topology, hardware components, software components, and running modes. During data taking, access is provided to monitoring information like statistics data, sampled data fragments to be analysed by monitoring tasks, histograms produced in the TDAQ system, and also to the errors and diagnostic messages sent by different applications. User interfaces display the status and performance of the TDAQ system and allow the user to configure and control the operation. These interfaces provide comprehensive views of the various sub-systems for different types of users and operations.

The Online Software distinguishes various types of user. The TDAQ Operator runs the TDAQ System in the control room during a data-taking period; the TDAQ Expert has system-internal knowledge and can perform major changes to the configuration; the Sub-system Expert or Detector Expert is responsible for the operation of a particular sub-system or detector; and TDAQ and detector software applications use services provided by the Online Software via application interfaces. These types of users are defined in detail in Appendix B. The user requirements to the Online Software are collected and described in the corresponding document [10-1].

### 10.2 The architectural model

The Online Software architecture is based on a component model and consists of three high-level components, called packages. Details of the architecture and a comprehensive set of use cases are described in [10-2]. Each of the packages is associated with a group of functions of the Online Software. For each package, a set of services which it has to provide is defined. The services are clearly separated one from another and have well defined boundaries. For each service a low-level component, called a sub-package, is identified.

Each package is responsible for a clearly defined functional aspect of the whole system.

1. **Control** — contains sub-packages for the control of the TDAQ system and detectors. Control sub-packages exist to support TDAQ system initialization and shutdown, to provide control command distribution, synchronization, error handling, and system verification.
2. **Databases** — contains sub-packages for configuration of the TDAQ system and detectors. Configuration sub-packages exist to support system configuration description and access to it, record operational information during a run and access to this information. There are also boundary classes to provide read/write access to the conditions storage.
3. **Information Sharing** — contains classes to support information sharing in the TDAQ system. Information Sharing classes exist to report error messages, to publish states and statistics, to distribute histograms built by the sub-systems of the TDAQ system and detectors, and to distribute events sampled from different parts of the experiment's data flow chain.

The interaction between the Online Software packages is shown in Figure 10-2. The Control makes use of the Information Sharing and of the Databases packages. The Databases package is used to describe the system to be controlled. This includes in particular the configuration of TDAQ Partitions, TDAQ Segments, and TDAQ Resources. The Information Sharing package provides the infrastructure to obtain and publish information on the status of the controlled system, to report and receive error messages, and to publish results for interaction with the operator.

The following sections describe these packages in more detail.

### 10.3 Information sharing

There are several areas where information sharing is necessary in the TDAQ system: synchronization between processes, error reporting, operational monitoring, physics event monitoring, etc. The Online Software provides a number of services which can be used to share information

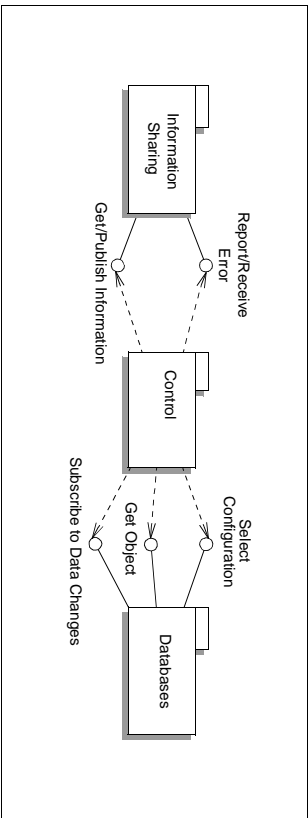

Figure 10-2 Internal interaction between the Online Software packages

between TDAQ software applications. This section will describe the architecture and prototype implementation of these services.

### 10.3.1 Functionality of the Information Sharing Services

Any TDAQ software application may produce information which is of interest for other TDAQ applications. In this section the application that produces information is called the Information Provider, the application that reads information data is called Information Consumer, which indicates that it is a user of the information. Any TDAQ software application may be an Information Provider and an Information Consumer at the same time. The main responsibility of the Information Sharing services is:

- transportation of the information from the Information Providers to the Information Consumers
- delivery of information requests (commands) from the Information Consumers to the Information Providers.

Figure 10-3 shows the main interactions which providers and consumers may have with the Information Sharing services.

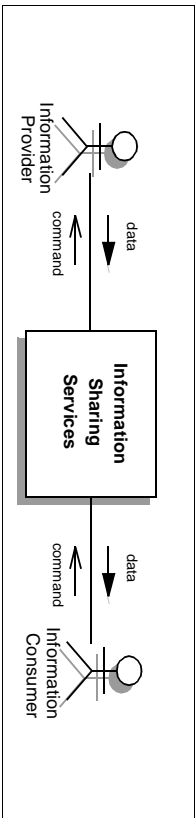

Figure 10-3 Information Sharing in the TDAQ system

#### 10.3.1.1 Types of shared information

There are many types of information which can be shared between applications in the TDAQ system. These types are significantly different in terms of the data size, update frequency, type

of access, number of providers and consumers, etc. In order to optimize the performance of the information sharing in a large and highly distributed TDAQ system a separate service for each major class of the shared information is provided. Table 10-1 shows the main information types along with their most important characteristics.

Table 10-1 Types of shared information

Information type	Information structure	Providers produce this data...	Consumers access this data...
Physics events (or event fragments)	vector of 4-byte integers	on request	on request
Error messages	error id + description + optional qualifying attributes	when errors occur	via subscription
Histograms	several widely used histogram formats (e.g. ROOT histograms)	always	on request and via subscription
Status information	user-defined	always	on request and via subscription

### 10.3.2 Performance and scalability requirements on Information Sharing

The performance and scalability requirements vary according to the type of the information. Table 10-2 shows the summary of these requirements for the main types of shared information.

Table 10-2 Performance and scalability requirements for Information Sharing

Information type	Information size (kbyte)	Update frequency (Hz)	Number of providers	Number of consumers
Physics events (or event fragments)	1.5-2.2 × 10 <sup>3</sup>	O(1)-O(10 <sup>3</sup> )	O(10 <sup>2</sup> )	O(10 <sup>2</sup> )
Error messages	O(1)	O(10)	O(10 <sup>3</sup> )	O(10)
Histograms	O(10)	O(1)	O(10 <sup>2</sup> )	O(10)
Status information	O(1)	O(1)	O(10 <sup>3</sup> )	O(10)

The final ATLAS TDAQ system will contain O(10<sup>3</sup>) processes. Each of them can produce error messages and status information. The Information Consumers for the error messages are the applications which log errors, analyse them, present them to the operator, or try to do a recovery. The consumers of the status information are the applications that monitor the status of a particular component of the TDAQ system or detector, present this information to the operator, and possibly perform corrective actions when spotting problems. Therefore the Information Sharing services dealing with the errors and user-defined information have to be able to serve O(10<sup>3</sup>) Information Producers and O(10) Information Consumers simultaneously.

Physics events (or event fragments) can be sampled from several hundred places in the data flow chain. Events can be sampled at ROD crate level, at the ROS level, and at the SFL level. In the worst case, if events are monitored at all the possible points simultaneously, there will be approximately the same number of Information Consumers for this information type.

The possible sources of histograms are ROD controllers, ROSS, SFIS, LV12 sub-farms, and EF sub-farms. For each of these systems there are several applications which receive histograms in order to present them to the operator, analyse, or store them. Therefore the Information Sharing service dealing with histograms, must be able to handle several hundred Information Providers and several tens of Information Consumers simultaneously.

### 10.3.3 Architecture of Information Sharing services

The Online Software provides four services to handle different types of shared information. Each service offers the most appropriate and efficient functionality for a given information type and provides specific interfaces for both Information Providers and Consumers. Figure 10-4 shows the existing services.

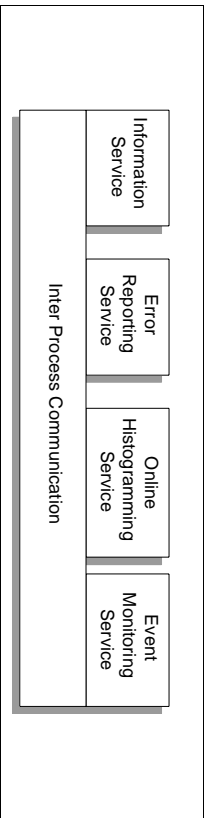

Figure 10-4 Information Sharing services

The Inter Process Communication (IPC) is a basic communication service which is common to all the other Online Software services. It defines the high-level API for the distributed object implementation and for remote object location. Any distributed object in the Online Software services has common basic methods which are implemented in the IPC. In addition the IPC implements partitioning, allowing several instances of the Online Software services to run in different TDAQ Partitions concurrently and fully independently.

#### 10.3.3.1 Information Service

The Information Service (IS) allows software applications to exchange user-defined information. Figure 10-5 shows interfaces provided by the IS.

Any Information Provider can make his own information publicly available via the Publish interface and notify the IS about changes of the published information via the Update interface. Here there are two possibilities: the Information Provider does not implement the InfoProvider interface, in which case it has to inform the IS about all the changes of the published information; the Information Provider does implement the InfoProvider Interface, in which case it notifies the IS about information changes only when it is explicitly requested by the IS via the Command interface. Some other commands might be also possible, e.g. setting time interval for the information updates.

There are also two types of Information Consumer. One can access the information on request via the Get Info interface, in which case it does not need to implement the InfoConsumer interface. The second type of Information Consumer implements the InfoConsumer interface, and is informed about changes of the information for which it subscribed, via the Subscribe interface.

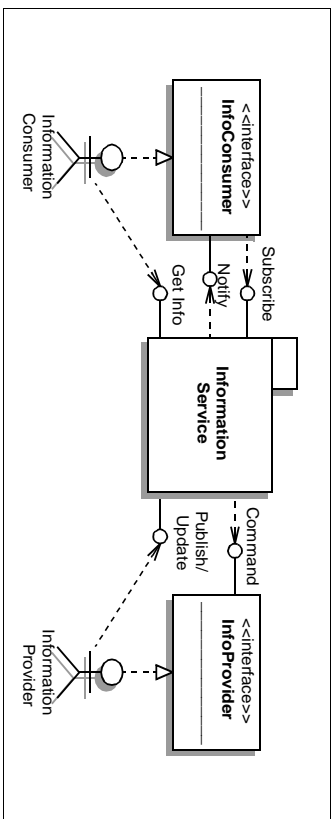

Figure 10-5 Information Service interfaces

#### 10.3.3.2 Error Reporting Service

The Error Reporting Service (ERS) provides transportation of the error messages from the software applications which detect these errors to the applications which are responsible for their handling. Figure 10-6 shows interfaces provided by the Error Reporting Service.

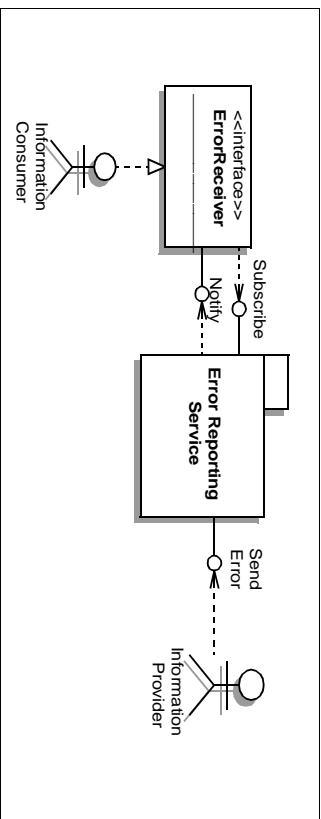

Figure 10-6 Error Reporting Service interfaces

An Information Provider can send an error message to the ERS via the Send Error interface. This interface can be used by any application which wants to report an error. In order to receive error messages an Information Consumer has to implement the ErrorReceiver interface and provide the criteria that define the kind of messages it wants to receive. These criteria have to be passed to the ERS via the Subscribe interface.

#### 10.3.3.3 Online Histogramming Service

The Online Histogramming Service (OHS) allows applications to exchange histograms. The OHS is very similar to the Information Service. The difference is that the information which is transported from the Information Providers to the Information Receivers has a pre-defined format. Figure 10-7 shows interfaces provided by the Online Histogramming Service.

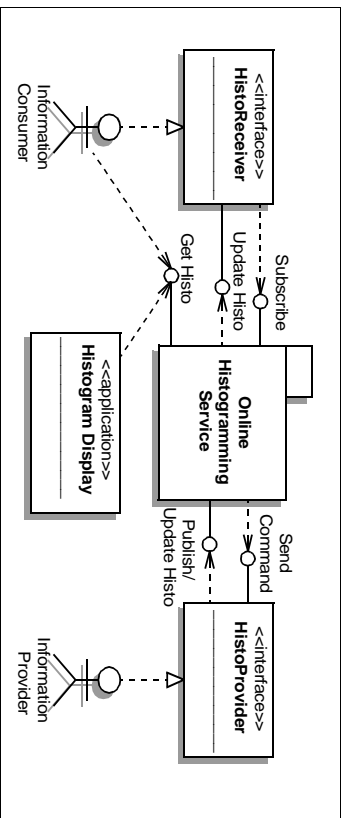

Figure 10-7 Online Histogramming Service interfaces

The OHS sub-package also provides a human user interface in the form of an application. This application is called Histogram Display and can be used by the TDAQ operator to display available histograms.

### 10.3.3.4 Event Monitoring Service

The Event Monitoring Service (EMS) is responsible for the transportation of physics events or event fragments sampled from well-defined points in the data flow chain and delivered to analysis applications. These will examine and analyse the data in order to monitor the state of the data acquisition and the quality of the physics data in the experiment. Figure 10-8 shows the main interfaces provided by the Event Monitoring Service.

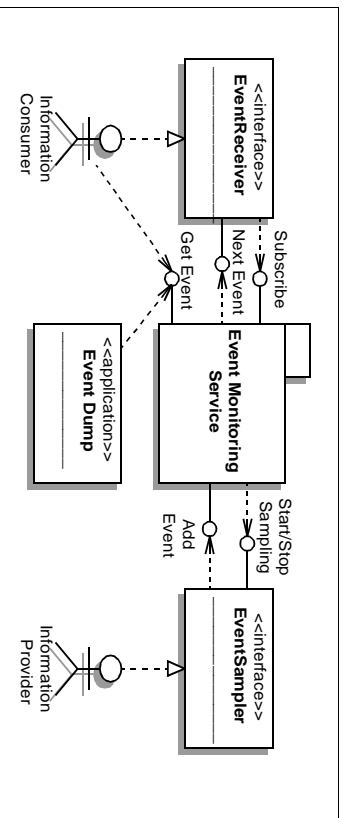

Figure 10-8 Event Monitoring Service interfaces

The application, which is able to sample events from a certain point of the data flow, has to implement the Event Sampler Interface. When the Information Consumer requests samples of events from that point, the EMS system requests the Information Provider, via the Start Sampling interface, to start a sampling process. The Information Provider samples events and provides them to the EMS via the Add Event interface. When there are no more Information

Consumers interested in event samples from that point of the data flow chain, the EMS requests the Information Provider via the Stop Sampling interface to stop the sampling process.

There are also two types of interface for the Information Consumer. One is a simple Get Event interface which allows a consumer to request event samples one by one according to need. This interface will be used, for example, by the Event Dump application that implements a human user interface to the EMS system. A second interface is based on the subscription model. The Information Consumer can request the EMS system to supply the samples of events as soon as they are sampled by the Information Provider. This interface is more suitable for the monitoring tasks which need to monitor events for a long period of time in order to accumulate the necessary statistics.

### 10.3.3.5 Relation between Information Sharing services

All the Information Sharing services described above have essential differences because they have to deal with different types of shared information. On the other hand, similarities can be identified since they use common communication patterns, for example the subscribe/notify mechanism. The generic patterns are reused by different services whenever it is possible without loss of efficiency. For example, in the current implementation the Histogramming Service is implemented on top of the more general Information Service. The Histogramming Service defines its own specific interfaces but reuses all the communication mechanisms provided by the IS.

## 10.3.4 Prototype evaluation

Prototype implementations exist for all the Information Sharing services. These prototypes aim to verify the suitability of the chosen design and the choice of implementation technology for the final TDAQ system, and for use at the ATLAS test beam operations. This section contains a description of the services implementation together with their performance and scalability test results.

### 10.3.4.1 Description of the current implementation

Each service is implemented as a separate software package with both C++ and Java interfaces. It is possible to have several instances of each service running concurrently and fully independently in different TDAQ partitions.

The Information Sharing services implementation is based on the Common Object Request Broker Architecture (CORBA) [10-4] defined by the Object Management Group (OMG). CORBA is a vendor-independent industry standard for an architecture and infrastructure that computer applications use to work together over networks. The most important features of CORBA are object-oriented communication, inter-operability between different programming languages and different operating systems, and object location transparency.

Currently the open source implementation of CORBA provided by the Xerox company is used. It is called Inter Language Unification (ILU) [10-3]. Several other CORBA implementations are currently being evaluated. These are TAO [10-5], MICO [10-6], omniORB [10-7], and ORBacus [10-8]. They provide interesting features which are missing in ILU. ILU can be replaced by an-

other CORBA implementation without affecting the architecture and design of the Information Sharing services.

### 10.3.4.2 Performance and scalability of current implementation

Among the Information Sharing services, the most extensive tests have been performed for the Information Service, which provides the most general facility for information sharing. The other services are implemented on the same technology and will offer the same level of performance and scalability as the IS.

The test bed for the IS tests consisted of 216 dual-pentium PCs with processor frequencies from 600 to 1000 MHz [10-9]. The IS server was set up on one dedicated machine. From one to five Information Providers were running on the other 200 machines. Each Information Provider published one information object at the start and then updated it once per second. The remaining 15 machines were used to run 1, 5, 10 or 15 Information Consumers which subscribe for all the information in the IS. Whenever an Information Provider changed the information, this new information was transported to all the Information Consumers.

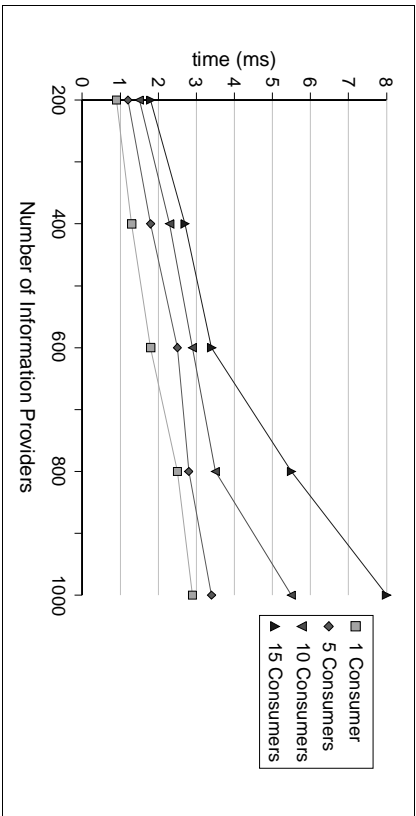

Figure 10-9 Average time spent to transport one information object from one Information Provider to a number of Information Consumers versus the number of concurrent Information Providers

Figure 10-9 shows the average time for transporting information from one Information Provider to all the subscribed Information Consumers as a function of the number of Information Providers, which were working concurrently.

The results of the tests show that a single IS server is able to handle one thousand Information Providers and about 10 Information Consumers at the same time. The design of the IS allows the total load to be distributed among a number of independent IS servers. Thus, it will be necessary to run only a few (less than 10) IS servers in order to provide the required performance for the final ATLAS TDAQ.

### 10.3.4.3 Usage of Information Sharing services by the TDAQ sub-systems

Usage of the Information Sharing services as they are described above will be very similar to that of the existing prototype implementations. These have been in use in various test beds and test beam activities and provide good examples for their use in the final TDAQ system. A typical test beam configuration, which was exploited by the detectors, includes the Error Reporting Service (called Message Reporting System (MRS) in the prototype implementation) and a number of Information Services. In particular, the IS server for the Run Parameters was used to distribute the run parameters such as run number, run type, beam type, etc., which previously had been defined by the operator, to system and user applications. An IS server specific for the detector information was running and passed the status of the detector hardware such as RODs, LVL1 Modules, etc. to the operator during a run. The IS server for Data Flow parameters was used to present the status of the data flow elements to the operator, and an IS server specific to DCS parameters passed important DCS parameters on. The test beam operator used the TDAQ Online Software user interface application called Integrated Graphical User Interface (IGUI) to interact with the Information Sharing services. The IGUI application contains the message display, which shows text messages sent by the TDAQ and detector applications via MRS. The IGUI also includes the Data Flow panel, which displays the status of the data flow elements to the operator, and the Run Parameters panel, from where the operator can define parameters for the next run. In addition some detector teams implemented their own custom Java panels, which were integrated into the IGUI. These panels interacted with the various IS servers to fetch the detector-specific information and displayed it to the operator. The Event Monitoring Service was extensively used during the test beams by all detector groups. They developed specific applications, which conform to the Eventsampler interface defined by the EMS. These applications were running on the ROD crate controllers of each ROD crate. A variety of monitoring tasks, receiving the events, had been developed in the detector groups and were running on dedicated workstations. Monitoring tasks gathered statistics about the sampled events or displayed the events to the operator. A very interesting application was developed in the TGC team implementing an Online Event Display in Java, which receives events from the EMS and displays them in graphical form.

## 10.4 Databases

The TDAQ systems and detectors require several persistent services to access the description of the configuration used for the data taking as well as to store the conditions under which the data were taken. The Online Software provides common solutions for such services taking into account the requirements coming from the TDAQ systems and detectors.

### 10.4.1 Functionality of the databases

There are three main persistent services proposed by the Online Software:

- the **Configuration Databases** (ConDBs) to provide the description of the system configurations;
- the **Online Bookkeeper** (OBK) to log operational information and annotation,
- the **Conditions Database Interface** to store and read conditions under which data were taken.



#### 10.4.1.1 Configuration Databases

The ConDBs are used to provide the overall description of the TDAQ systems and detector hardware and software. They include the description of partitions defined for the system. The hardware and software are described in a flexible way and parameterized in such a way the described configuration can be used for different types of runs.

The ConDBs are organized in accordance with the hierarchy of the TDAQ system and detectors. They allow for each TDAQ system and detector to define their specific format of the data (i.e. the database schema), to define the data themselves, and to share the schema and the data with others. They provide graphical user interfaces for the human user to browse the data and for authorized human experts to modify the data. Data access libraries hide the technology used for the databases implementation and are used by any TDAQ or detector application to read the configuration description or to be notified in case of changes. An application started by an authorized expert can use the data access libraries to generate or to modify the data.

The ConDBs provide an efficient mechanism for fast access to the configuration data for a large number of clients during data taking. They do not store the history of the data changes which is the task of the OBK but provide archiving options. Configuration data which are important for offline analysis must be stored in the Conditions Database.

#### 10.4.1.2 Online Bookkeeper

The OBK is the system responsible for the online storage of relevant operational information, histograms, and the configuration description provided by the TDAQ systems and detectors. It organizes the stored data on a per-run basis and provides querying facilities.

The OBK provides a graphical user interfaces to allow human users to browse contents of the recorded information or append such information. The option for appending information is limited to authorized users. Similarly, the OBK provides programming interfaces for user applications to browse the information or to append annotations.

#### 10.4.1.3 Conditions Database interfaces

The TDAQ systems and the detectors use the Conditions Database to store conditions which are important for the offline reconstruction and analysis. The conditions data include parameters such as temperature, pressure, and voltage and vary with time. These conditions are stored with a validity range which is typically expressed in time or run number and retrieved again using the validity range as a key.

The Conditions Database is expected to come from an LHC Computing Grid [10-10] applications area project, with any ATLAS-specific implementation supported by the Offline Software group. The Online Software system provides application programming interfaces for all TDAQ systems and detector applications, and mechanisms to ensure the required performance during data-taking runs.

### 10.4.2 Performance and scalability requirements on the databases

The performance and scalability requirements of the database services are strongly dependent on the strategies chosen by the TDAQ systems and detectors to transport the data to their appli-

cations, to store the conditions, and to keep the operational data. For most TDAQ systems and detectors, the number of estimated clients of the Configuration and of the Conditions Databases is roughly equal to the number of local controllers (as explained in Section 10.5.3), which are estimated to be between 500 and 2000. For the Event Filter the situation is not yet defined and the number of database clients in the worst-case scenario can be  $O(10^3)$ , if each processing task needs to receive the configuration description and conditions.

The database information can be split into a number of independent parts according to TDAQ systems and detectors. The complete description is required only by a few applications, while most others require access to only a small fraction of it. The typical database size which completely describes all the necessary parameters of the TDAQ system or a detector for a physics run is about  $O(10^2)$  MByte. The DCS may produce up to 1 Gbyte of measured conditions per day.

The ConDBs data are read once in preparation for data taking and an acceptable time to get the description for the whole system is of  $O(10)$  s. During physics data taking selected parts of the databases may be changed and an acceptable time to receive the changes by registered applications is of  $O(1)$  s. During special calibration runs a considerable fraction of the data can change and the maximum rate requested in this case is 10 Mbytes per hour.

### 10.4.3 Architecture of databases

#### 10.4.3.1 Configuration Databases

The ConDBs provide user and application programming interfaces.

Via a user interface the software developer defines the data object model (database schema) describing the required configurations. The expert uses the interface to manage databases, to populate the system description, and to define configurations, which can subsequently be browsed by a user.

A TDAQ or detector application accesses the databases via data access libraries (DALs). A DAL is generated by the software developer for the part of the object model which is relevant to his sub-system. It is based on a database schema to programming language mapping and related instantiation of database objects as programming language objects. The user of a DAL never sees the low-level database management system (DBMS) and his code can be used without changes for different database systems. The DAL is used by any process required to get the configuration description or to receive a notification in case of changes. The DAL is also used by an expert process to produce the configuration data.

Figure 10-10 shows the main classes and interfaces provided by the ConDB system and their users.

The ConDB system contains the following classes:

- **ConDB Repository** — defines low-level interfaces to manipulate the ConDBs including database management by users who are granted the respective privileges, schema and data definitions and notification subscription on data changes; it defines interfaces above a DBMS used for implementation and hides any specific details, so any other ConDB classes must never use DBMS-specific methods directly;

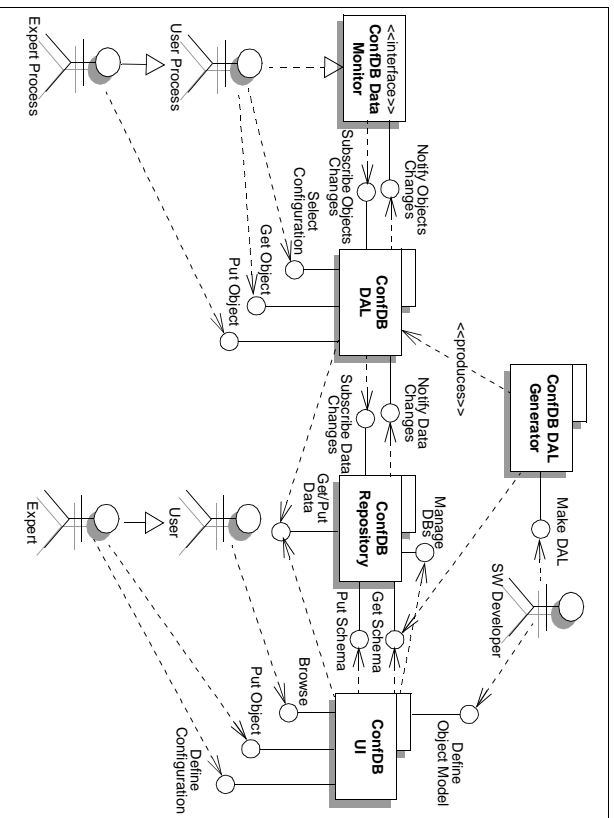

Figure 10-10 Configuration Databases users and interfaces

- **ConIDB UI** (User Interface) — defines the user interface for object model definition, configurations definition, database browsing and population by human users;
- **ConIDB DAL Generator** — defines the interface to produce a DAL;
- **ConIDB DAL** — defines interfaces for configuration selection, reading and writing of configuration objects, and subscription for notifications on data changes by user and expert processes;
- **ConIDB Data Monitor** — defines interfaces to receive notification of changes.

#### 10.4.3.2 Online Bookkeeper

The OBK provides several interfaces to its services, some of them are to be used by the human user, while others are APIs to allow interfacing with client applications. The access to these interfaces depends on the user's (human or system actor) privileges.

The OBK uses as persistence backbone the Conditions and Time-Varying offline databases services. It counts on those services to provide the necessary means to store and retrieve coherently data that changes in time and of which there may exist several versions (e.g. configurations). Figure 10-11 shows the logical subdivision of the OBK system into abstract classes. Of the ones shown, the main ones are:

- **OBK Repository** — defines the basic methods to allow for storing, modifying, and reading of online log data, as well as the methods to set the OBK acquisition mode and also to

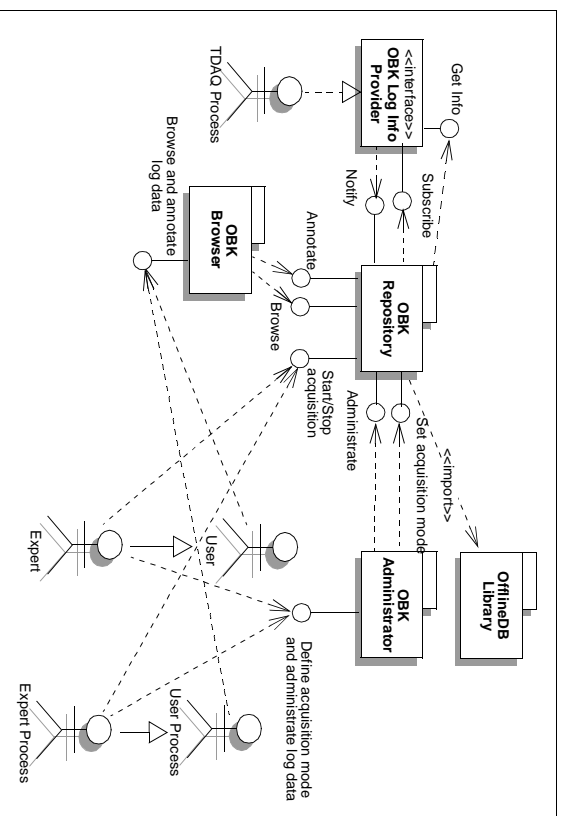

Figure 10-11 OBK users and interfaces

- request log data from the several TDQA processes providing them. It allows a human or system user to start or stop the acquisition of log data. In order to become a log data provider a TDQA application will have to contain the **OBK Log Info Provider** interface. This interface allows a TDQA application to accept subscriptions for log information from the OBK, as well as for the OBK to access log information in a TDQA application:
- **OBK Browser** — this is the class responsible for providing the necessary querying functionality for the OBK database. Since the data browsing and data annotation functions are tightly coupled, the class also includes functionality to add annotations to the database;
  - **OBK Administrator** — the OBK Administrator class provides to the users, which are granted the respective privileges, the functionality to alter (delete, move, rename) parts or all of the OBK database. These users are also given the possibility of changing the OBK acquisition mode (e.g. data sources, filters for the data sources).

Apart from the main classes depicted in Figure 10-11, the OBK architecture also includes four other classes (not shown in the diagram for reasons of clarity): The **OBK UI Browser** and the **OBK Browser API** both inherit from the OBK Browser class and define the human client oriented and the application client oriented versions of that class. Similarly the **OBK UI Administrator** and the **OBK Administrator API** classes define the human client and application client oriented versions of the OBK Administrator class.

#### 10.4.3.3 Conditions Database interface

The user requirements for the ATLAS offline conditions and time-varying databases and their architecture are not yet fully specified by the ATLAS user community. The Conditions Database

interface will provide additional functionality if required by TDAQ and detector users, beyond the one provided by the Offline Software.

#### 10.4.4 Prototype evaluation

The main functions of the ConTDB and the OBK have been implemented and evaluated in the prototype of the Online Software. The main goals were its use during test beam operations, the integration with other TDAQ sub-systems and detectors, and the evaluation of the suitability of the chosen technologies for the final system.

##### 10.4.4.1 Scalability and performance tests of the Configuration Databases

The prototype of the ConTDBs is implemented on top of the OKS [10-11] persistent in-memory object manager. It allows the storage of the database schema and data in multiple XML files. Several subsets can be combined to get a complete description. Access to the configuration description can be made via a file system (C++ interface) and via a dedicated remote database server built on top of ILU [10-3] and tested for C++ and Java Interfaces.

Figure 10-12 presents the database test results obtained during the Online Software large-scale and performance tests [10-9]. The options to read a realistic configuration via the AFS file system and from a remote database server were tested for the maximum available number of nodes. The tests with direct concurrent access to the configuration via the common AFS file system showed good scalability and performance as presented in the first graph of Figure 10-12. Such an approach can be envisaged if a common file system is available. The second graph in Figure 10-12 presents the time necessary to read different sizes of information from one database server depending on the number of concurrently reading clients. The third graph in Figure 10-12 shows the time necessary to read one information object from one database server for the case where the read request by the clients is initiated synchronously and for the case where the requests are randomly distributed over one second. Given a particular situation, one can derive from the graphs the number of necessary database servers in the system depending on the number of clients, timing requirements, data volume, and request synchronization.

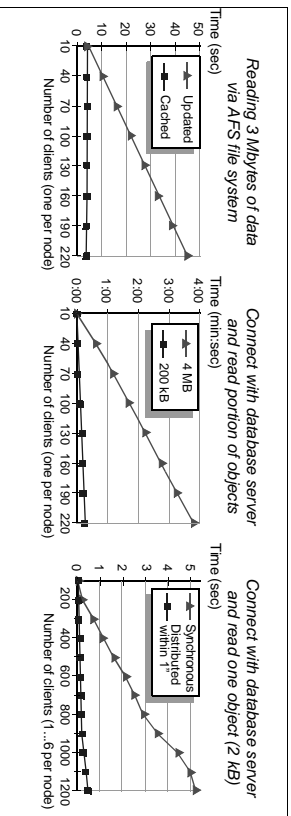

Figure 10-12 Results of the databases performance and scalability tests

The proposed architecture of the ConTDBs allows switching between implementation technologies without affecting user code. Some other database technologies are being studied for possible replacement of the ones used in the prototype, including relational databases with possible

object extensions, and the Pool Of persistent Objects for LHC (POOL) [10-12] from the LHC Computing Grid (LCC) [10-10] project.

##### 10.4.4.2 Online Bookkeeper

The prototype of the OBK was implemented on an OKS persistent in-memory object manager and MySQL [10-13] freeware implementation of a relational database management system. The results obtained during recent performance and scalability tests [10-9] have shown that the current MySQL implementation can reach a rate of 20 kbyte/s when storing monitoring data (100 bytes per data item) produced by up to 100 providers.

## 10.5 Control

The main task of the control package is to provide the necessary tools to perform the TDAQ system operation as described in Chapter 3, "System Operations". It provides the functionality of the TDAQ Control as shown in the controls view in Chapter 5, "Architecture".

In addition, the package has the responsibility for the functions necessary for user interaction, process management, and access control in the computing environment.

### 10.5.1 Control functionality

Control encompasses software components responsible for the control and supervision of other TDAQ systems and the detectors. The functions have been derived from the user requirements and are:

- **User Interaction:** Interaction with the human user such as the operator or expert of the TDAQ system
- **Initialization and shutdown:** Operations for the initialization of TDAQ hardware and software components are foreseen. The operational status of system components must be verified and the initialization of these components in the required sequence ensured. Similar considerations are required for the shutdown of the system.
- **Run control:** System commands have to be distributed to many hundreds of clients programs. The control sub-package is responsible for the command distribution and the synchronization required between the TDAQ sub-systems and detectors.
- **Error handling:** Malfunctions can interrupt system operations or adversely affect the quality of physics data. It is the task of the control sub-package to identify such malfunctions. If required the system will then autonomously perform recovery operations and assist the operator with diagnostic information.
- **Verification of System status:** The control package is responsible for verifying the functioning of TDAQ configuration or any subset of it.
- **Process Management:** Process management functionality in a distributed environment is provided.
- **Resource Management:** Management of shared hardware and software resources in the system is provided.

- **Access Management:** The control package provides a general Online Software safety service, responsible for TDAQ user authentication and the implementation of an access policy for preventing non-authorized users corrupting TDAQ functionality.

## 10.5.2 Performance and scalability requirements on Control

The TDAQ system is a large and heterogeneous system composed of a large number of items to be controlled. Typically these items are clustered and range from readout modules in VME crates to workstations within HLT computer farms. Such clusters are the preferred places to interface with the Online Software Control system. The number of these clusters is estimated to be in the range of 500–1000. To control these units the TDAQ control system is built in a hierarchical and distributed manner. More detailed explanation can be found in Section 12.3.

## 10.5.3 Control architecture

The Control package is divided into a number of sub-packages as shown in Figure 10-13. The functionality described in Section 10.5.1 has been distributed between several distinct sub-packages:

- The User Interface (UI) for interaction with the operator
- The Supervision for the control of the data-taking session including initialization and shutdown, and for error handling
- The Verification for analysis of the system status
- The Process Management for the handling of processes in the distributed computing environment
- The Resource Management for coordination of the access to shared resources
- The Access Management for providing authentication and authorization when necessary.

### 10.5.3.1 User Interface

The **User Interface (UI)** provides an integrated view of the TDAQ system to the operator and should be the main interaction point. A flexible and extensible UI will be provided that can accommodate panels implemented by the detectors or TDAQ systems. Web-based technologies will be used to give access to the system for off-site users.

### 10.5.3.2 Supervision

The **Supervision** sub-package realizes the essential functionality of the Control package. The generic element is the controller. A system will generally contain a number of controllers organized in a hierarchical tree, one controller being in control of a number of others in the system while being controlled itself from a higher level controller. One top level controller, called the root controller, will take the function of the overall control and coordination of the system. The User Interface sub-package provides all TDAQ control facilities to the Operator. These are shown as interfaces in Figure 10-14 and discussed below in more detail.

The Initialization and Shutdown is responsible for:

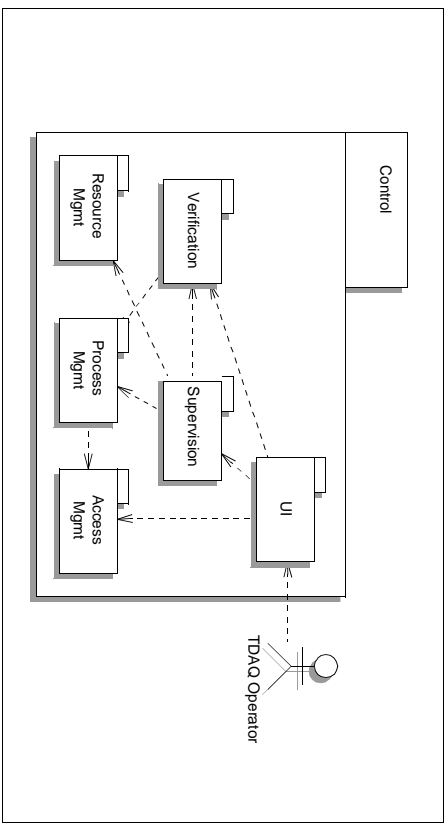

Figure 10-13 The organization of the control package

- initialization of TDAQ hardware and software components, bringing the TDAQ partition to the state in which it can accept Run commands
- re-initialization of a part of the TDAQ partition when necessary
- shutting the TDAQ partition down gracefully
- TDAQ process supervision

The Run Control is responsible for

- controlling the Run by accepting commands from the user and sending commands to TDAQ sub-systems
- analysing the status of controlled sub-systems and presenting the status of the whole TDAQ to the Operator

The Error Handling is concerned with

- analysing run-time error messages coming from TDAQ sub-systems
- diagnosing problems, proposing recovery actions to the operator, or performing automatic recovery if requested

Most of the above-defined functionality can reside in a so-called Local Controller and is extended by specific policies which the TDAQ sub-systems and detector expert developers implement. The interface and policies of the Local Controller can be configured by the user using a Policy/Knowledge Interface. In addition the supervision can profit from functionality provided by the Verification sub-system.

### 10.5.3.3 Verification

The **Verification** sub-package is responsible for the verification of the functioning of the TDAQ system or any subset of it. It uses developer's knowledge to organize tests in sequences, analyse

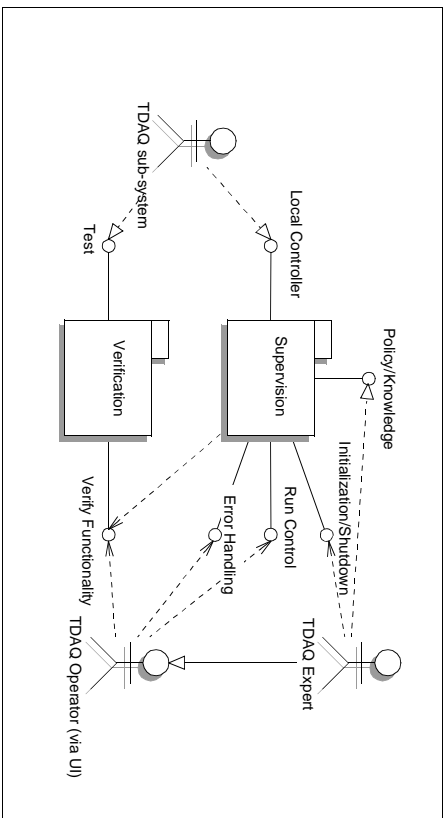

Figure 10-14 Interfaces of the Supervision and Verification sub-packages

test results, diagnose problems, and provide a conclusion about the functional state of TDAQ components.

A TDAQ sub-system developer implements and describes tests which are used to verify any software or hardware component in a configuration. This includes also complex test scenarios, where the component functionality is verified by the simultaneous execution of processes on several hosts. The sub-system uses the Process Management sub-package for the execution of tests.

The verification sub-system provides access to its functionality via the Verify Functionality interface. The sub-system is built on specific tests that probe the functionality of the Online Software, TDAQ sub-system or Detector functionality. These tests connect by the Test interface to the verification sub-system.

The Verification sub-package is used by the Supervision to verify the state of the TDAQ components during initialization or recovery operations. It can also be used directly by the Operator via the UI, as shown in Figure 10-14.

#### 10.5.3.4 Process, Access and Resource Management systems

The Verification and Supervision sub-packages connect via interfaces to other Control sub-packages, as shown in Figure 10-15.

The **Process Management** provides basic process management functions in a distributed environment. These include starting, stopping, and monitoring processes on different TDAQ hosts. While its main users are the Supervision and Verification, it is also available for other user applications. It avoids the overhead of standard operating system tools and allows the management of the large number of processes involved in the TDAQ system.

The **Resource Management** is concerned with the allocation of software and hardware resources between running partitions. It is used by the Supervision and by the Process Management. It

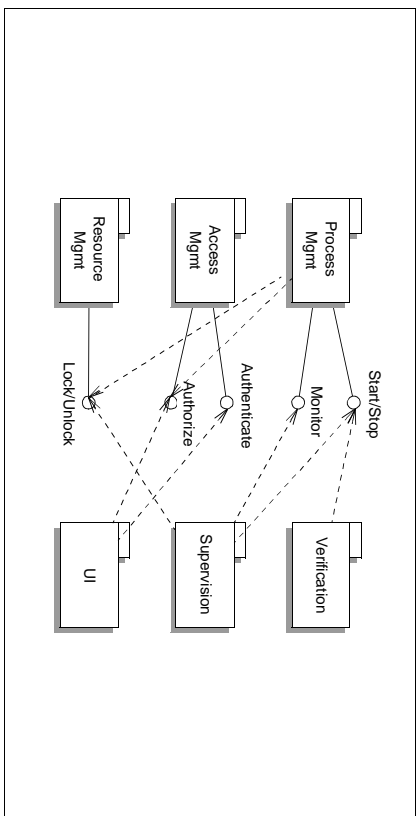

Figure 10-15 Interfaces of the Process Management, Resource Management and the Access Management

prevents the operator from performing operations on resources which are allocated to other users. This is of particular need during commissioning and testing phases, where many groups are working independently and have to share resources.

The **Access Management** is a general Online Software safety service, responsible for TDAQ user authentication. It implements an access policy, in order to stop non-authorized persons from corrupting the TDAQ system and interfering with data taking. This applies in particular to sensitive areas like the access to configuration databases, access to process management, remote access through the Web, etc. Apart from these cases, the limited access to the network at the experiment site is the main security measure.

#### 10.5.4 Prototype evaluation

Prototype evaluations have been performed for a number of technologies. The initial choice was based on experience in previous experiments. Products were chosen that fit well in the proposed object-oriented software environment.

- A Run Control implementation is based on a State Machine model and uses the State Machine compiler, CHSM [10-14], as underlying technology.
- A Supervisor is mainly concerned with process management. It has been built using the Open Source expert system CLIPS [10-15].
- A verification system (DVS) performs tests and provides diagnosis. It is also based on CLIPS.
- A Java-based graphical User Interface (IGUI) is being used.
- Process Management and Resource Management are based on components which are part of the current implementation of the Online Software packages.

#### 10.5.4.1 Scalability and performance tests

A series of large-scale performance tests has been performed to investigate the behaviour of the prototype on systems of the size of the final TDAQ system [10-9]. In several iterations the behaviour of the system was studied and limits were identified, the prototype was refined and tested until the successful operations of a system with a size in the required range was reached. Up to 1000 controllers and their applications were controlled reliably while meeting the performance requirements.

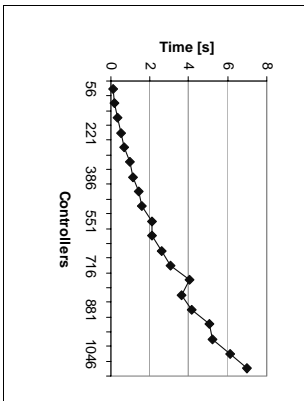

Figure 10-16 Time to perform three TDAQ state transitions for configurations in the range of O(10) to O(1000) controllers

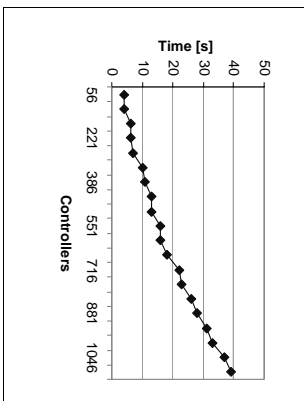

Figure 10-17 Time to start the processes for configurations in the range of O(10) to O(1000) controllers

Of note is the synchronized distribution of commands within the system. A command is sent by the root controller and propagates through the controller tree to the leaf controllers. These leaf controllers interface between the overall online control system and the specific tasks to be performed in the TDAQ system. The time to distribute a command from the top level and to obtain the confirmation from all controllers was measured. Figure 10-16 shows the time taken to perform three successive state transitions for a three level control hierarchy for configurations in the range of 10–1000 leaf controllers. A single transition takes about two seconds for 1000 controllers, a time well within expectations. In a real system each controller would perform its specific actions during such a state transition taking between a few seconds and up to tens of seconds. In relation to these values the overhead of the overall control system is small.

Also of note is the process control in the distributed system. To switch between various configurations it will be necessary to start and stop many processes on many nodes. Although such an operation is not performed during physics data-taking, it will be of importance during development and calibration. Figure 10-17 shows the time to start the processes for a system with up to a thousand controllers. Detailed descriptions and further test results can be found in [10-9].

#### 10.5.4.2 Technology considerations

During the evaluation of the prototype several shortcomings of the current system were identified. An important one is the lack of flexibility in the state machine implementation CHSM. In this context the expert system CLIPS [10-15] and related products were studied. The general-purpose nature of this product allows the various aspects of the supervisor-like initialization, control, and error handling to be implemented. The knowledge base provides the basis for customizable solutions, which can be specialized for different parts of the system. Another advan-

tage is the extensibility of CLIPS. It can be interfaced easily with other components of the Online Software system. Alternative products also under consideration are Jess [10-16], a similar expert system implementation written in Java and a commercial alternative, Eclipse by Hayley Inc. [10-17].

Further alternatives have been investigated: SMI++ is a system that models the controlled domain as a system of interacting state machines [10-18] and is in use at several HEP experiments. Another possibility would be the use of general-purpose scripting languages, such as Python [10-19]. While each of these approaches has its particular merits, the evaluation showed that the CLIPS-based solution is better suited for our environment and is the favoured implementation choice.

## 10.6 Integration tests

### 10.6.1 Online Software integration and large-scale performance tests

Major releases of the integrated Online Software System were tested in several test series starting in the year 2000. All the major components were included. For the most recent series of tests in January 2003 [10-9], 222 dual-Pentium PCs of the CERN IT LXSHARE test-bed were used. They were equipped with 600–1000 MHz Pentium III processors, 512–1024 Mbytes of memory, and were running the Linux RedHat 7.3 operating system.

The tests were aimed at verifying the overall functionality of the Online Software system on a scale similar to that of the final ATLAS installation (including up to 1000 leaf controllers) and at studying the system performance aspects in detail. A number of performance measurements for the Online Software components were also performed as a function of the system size. Details of these can be found in the component test descriptions on IS in Section 10.3.4.2, on Databases in Section 10.4.4.1, and on Control aspects in Section 10.5.4.1.

The tests followed the sequence of steps which are necessary for TDAQ start-up, running, and shut-down actions. Realistic conditions for the Online Software infrastructure were simulated by including additional traffic from monitoring activities in the detectors and sub-systems. This traffic included monitoring of statistical data and status information, error messages, histograms, and event data monitoring. Online Software specific aspects like the configuration and the control sub-systems were studied. Various special-purpose controllers and infrastructure configurations were prepared to help identify possible shortcomings.

Different types of limitations were found in consecutive test cycle phases. After first having overcome limitations due to design or implementation flaws, limits built into the underlying communication software layer LUU and the underlying TCP/IP system configuration (e.g. the maximum number of allowed connections) were reached. Their discovery led to the development of specific solutions for the Online Software situation. Other limits concerned operating system parameters and therefore required tuning of the operating system and the use of alternative system calls to realize an Online Software system of the size of the final ATLAS system. The successful results showed that the current Online Software system already scales to the size of the final ATLAS system as shown in Section 10.5.4.1. Detailed studies of the results provided important feedback on the architecture and design in the context of the iterative development process. Optimization should reduce the demand on the operating system and provide addi-

tional safety margins. Furthermore, error handling and fault tolerance aspects will have to be extended and the user interface adapted.

### 10.6.2 Event Filter Software tests involving the Online Software

The Event Filter is implemented as software processes running on a large processor farm which for reasons of practicality is split into a number of sub-farms. A prototype Event Filter supervision system, responsible for all aspects of software task management and control in the Event Filter farm, was successfully implemented using services from the prototype implementation of the Online Software. The prototype uses the Online Software Configuration Database, Run Control system, and Supervisor.

The run controllers are arranged in a hierarchical tree with one run controller per sub-farm which collaborates with a sub-farm Supervisor to control and monitor the Event Filter processes in the sub-farm. The top-level of the hierarchy consists of a Supervisor which is responsible for controlling and monitoring the processes in the supervision infrastructure only (sub-farm Run Controllers and sub-farm Supervisors) and a root Run Controller. Note that in the Online Software prototype only one Supervisor process would normally be used to start all processes described in the configuration database. For better scalability, the use of multiple Supervisors was tested. This has led to a much more scalable system which complies at least in part with the proposed future design of the Online Software to HLT interface [10-20].

The scalability of the prototype system was tested at the same time and using the same cluster as that used for the latest Online Software scalability tests described in Section 10.6.1. Two types of configuration emulating Event Filter farms were studied:

- The total number of processing hosts was kept constant ( $\sim 200$ ) but split into differing numbers of sub-farms (3, 8, 20).
- The number of sub-farms was kept constant (10) and the number of hosts per sub-farm was varied (5, 10, 20).

Each sub-farm processing host ran two filtering tasks. In the largest configurations studied, more than 1000 processes were under the control of the prototype Event Filter Supervision system, representing about 10–20% of the EF system which will be used for the first ATLAS run.

Detailed results are given in [10-21]. All the configurations studied could be successfully launched, marshalled through the run control sequence, and shut down. The only operation requiring a non-negligible amount of time was the initialization of the online infrastructure. However, this is done only once per data-taking period and therefore is not very significant. Nevertheless the Online Software team addressed it in the design presented above. All other run control transitions are performed in a reliable and sufficiently rapid way. Observed transition times vary from 0.1 s to about 3 s, depending on the nature of the executed transition. Note that these times are a combination of the Event Filter specific activities required at each transition and implemented in the sub-farm Run Controllers, plus the Online Software overhead. Owing to the tree architecture of the control system, the transition times do not strongly depend on the number of controlled hosts. A limitation was found in the usage of the Configuration Database which should be better adapted to the use of a large number of similar, but not identical, devices: these devices are likely to be changed during data-taking activities (added to or removed from the configuration, for example, to cope with hardware failures) and this operation should not interfere with the process of data taking. A dedicated user interface was developed to hide the complexity of the current implementation of the underlying configuration database.

In the design of the configuration databases presented above in Section 10.4.3 most of the issues raised here are already addressed. A closer integration of this user interface with that provided by the Online Software is foreseen.

Suggested modifications, as explained above, were taken into account in the design presented earlier in this chapter and the Online Software is therefore quite adequate for the control of the Event Filter.

### 10.6.3 Deployment in test beam

Major releases of the current Online Software have been in use in three test beam operation periods since summer 2000. This allowed it to run under realistic conditions with the detectors similar to the LHC ones and with physics triggers. Valuable feedback on the behaviour of the prototype software was gathered and has led to improvements in design and implementation. Details can be found in [10-22].

## 10.7 References

- 10-1 I. Alexandrov et al., Online Software Requirements, ATL-DQ-ES-0015, <https://edms.cern.ch/document/388874/1.0>
- 10-2 I. Alexandrov et al., Online Software Architecture, ATL-DQ-ES-0014, <https://edms.cern.ch/document/388865/0.3>
- 10-3 ILLU home page, <ftp://ftp.parc.xerox.com/pub/illu/illu.html>
- 10-4 CORBA home page, <http://www.omg.org/corba/>
- 10-5 TAO home page, <http://www.cs.wustl.edu/~schmidt/TAO.html>
- 10-6 MICO home page, <http://www.mico.org/>
- 10-7 omniORB home page, <http://omniorb.sourceforge.net/>
- 10-8 ORBacus home page, [http://www.iona.com/products/orbacus\\_home.htm](http://www.iona.com/products/orbacus_home.htm)
- 10-9 D. Burchkart-Chromek et al., ATLAS TDAQ Online Software Large Scale Performance Tests January 2003, ATL-DQ-TR-0012, <http://edms.cern.ch/document/392827/1>
- 10-10 LCG, <http://leg.web.cern.ch/LCG>
- 10-11 OKS User's Guide, ATLAS DAQ TN # 033, <http://atdccc.cern.ch/Atlas/DaqSoft/components/configdb/docs/oks-ug/2.0/pdf/OksDocumentation.pdf>
- 10-12 POOL, <http://legapp.cern.ch/project/persist/>
- 10-13 MySQL, <http://www.mysql.com/>
- 10-14 P.J. Lucas, CHSM, An Object Oriented language system for implementing concurrent hierarchical finite state machines, Thesis, University of Illinois (1993)
- 10-15 CLIPS, <http://www.glg.net/clips/CLIPS.html>
- 10-16 Jess, <http://hetzberg.ca.sandia.gov/jess>

- 10-17 Eclipse, Rule based programming language and inference engine, see under products on <http://www.haley.com>
- 10-18 SMI++, <http://cern.ch/smi>
- 10-19 Python, <http://www.python.org>
- 10-20 D. Burchart-Chromek et al., HLT Online Software Interface, ATL-D-ES-0009, <https://edms.cern.ch/document/363702/1.0>
- 10-21 S. Wheeler et al., Test results for the EF Supervision, ATL-DH-TR-0001, <https://edms.cern.ch/document/374118/1>
- 10-22 I. Alexandrov et al., Systems Integration and Deployment in Test Beam and Large Scale Tests, ATL-DQ-TR-0006, <https://edms.cern.ch/document/390995/1.0>



# 11 DCS

## 11.1 Introduction

The principle task of DCS is to enable the coherent and safe operation of the ATLAS detector. All actions initiated by the operator and all errors, warnings and alarms concerning the hardware of the detector are handled by the DCS. For the operation of the experiment during data taking, a close interaction with the DAQ system is of prime importance. Safety aspects are not the responsibility of DCS. They are addressed by a dedicated Detector Safety System (DSS) and the global CERN-wide safety system, both of which DCS communicates with.

A Joint Controls Project (JCOP) [11-1] has been set up at CERN to address common points of controls for the four LHC experiments. Details of the scope and the responsibilities of JCOP are at present still being discussed.

In this chapter, first the architecture and the logical organisation of DCS are explained. Then follow descriptions of the different components and their interconnections. This leads to a discussion of the full read-out chain and its performance and some applications are given as examples. Finally, the communication of DCS with DAQ and with systems external to ATLAS is discussed.

## 11.2 Organization of the DCS

The architecture of the DCS and the technologies used for its implementation are constrained by both functional reasons and environmental aspects. The DCS consists of a distributed Back-End (BE) system running on PCs and of the different Front-End (FE) systems. The BE will be implemented with a commercial Supervisory Control And Data Acquisition system (SCADA). The DCS FE instrumentation consists of a wide variety of equipment, ranging from simple elements like sensors and actuators up to complex Front-End Controllers (FEC) for specialized tasks. The connection between FE and BE is provided by fieldbus or LAN.

The equipment of the DCS will be geographically distributed in three areas as schematically shown in Figure 11-1: the main control room SCX1 at the surface of the installations, the underground electronics rooms USA15 and US15, and the cavern of the detector. UX15, USA15 and US15 are equivalent with the exception, that the first is accessible to personal during beam operation. The SCADA components will be distributed over the main control and the electronics rooms, while the FE equipment will be placed in USA15, US15, and UX15. The relative independence of the operation of the subdetectors leads to the hierarchical organisation shown in Figure 11-1. In addition to the subdetectors exists a part for Common Infrastructure Controls (CIC) which monitors services provided to the experiment as a whole, like electricity or ventilation, and it supervises equipment which is in common to several subdetectors like electronics racks.

The FE electronics in UX15 is exposed to a strong magnetic field of up to 1.5 Tesla and to ionising radiation. The DCS FE equipment will be located outside of the calorimeters, where the dose rate is of the order of 1 Gray/year or less. This permits the use of selected commercial Components Of The Shelf (COTS), which however have to be individually qualified for radiation.

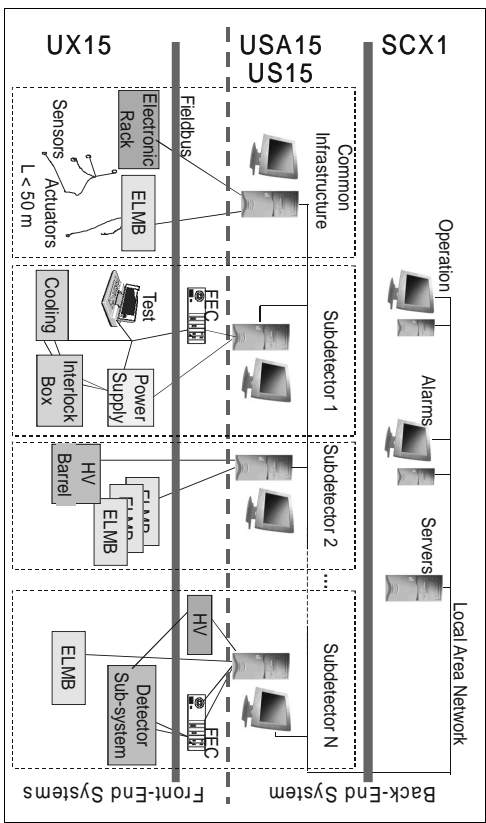

Figure 11-1 Geographical deployment of the DCS. some changes needed to this figure

tion following the 'ATLAS Policy on Radiation Tolerant Devices' [11-2]. FE equipment which can not operate under these conditions like processors-based devices (e.g. FEC) or some types of power supplies can be accommodated in the electronics rooms.

The BE system consists essentially of PCs and is organized in a tree like structure with several levels and will be described in detail in Section 11.4. The highest level which is situated in the control room provides all the tools needed for the integrated operation of the detector as a whole, like the operator interface, the alarm system and various servers. The workstation in the levels below provide the online data and command handling and full stand-alone operation capability for each subdetector. This gives operational independence to the subdetectors when needed, e.g. for commissioning, debugging or calibration. The connection between all PCs of the BE over a LAN is part of the SCADA software.

## 11.3 Front-End system

The front-end equipment connects directly to the detector hardware. It comprises sensors and actuators, digitisers, controllers and processors, commercial devices, and stand-alone computer-based systems. Concerning monitoring, the FE reads and digitises values, processes them in some cases and transfers the data to the BE. It also executes the commands, which it receives from the BE. The FE DCS of the subdetectors is the responsibility of the subdetector groups and is described in their TDRs. It consists of two categories of equipment, one being more general purpose and widely used in ATLAS and one being more specialised for a dedicated task. The first class is described in this TDR whereas for the second only the method and the point of connection to the BE is given here.

The FE equipment is distributed over the whole volume of the detector with cable distances of up to 200 m. Two conflicting aspects constrain the distribution underground. Because of the radiation level, the magnetic field, the limited space available, and the inaccessibility of UX15 during beam time, it is preferable to locate the equipment in the electronics rooms. However, complexity, cost and technical difficulties of cabling suggest condensing the data as much as possible in UX15 and transferring only the results to USA15 or US15.

The harsh environment in the cavern limits the types of technologies that may be used. For data transmission to the BE the CAN fieldbus [11-1] has been chosen amongst the CERN-recommended fieldbuses. CAN equipment is very robust, has excellent error detection and recovery, can be used over large distributed areas, does not use components sensitive to magnetic field and has good support from industry.

### 11.3.1 Embedded local monitor board

An electronics module called Embedded Local Monitor Board (ELMB) [11-4] has been developed for standard analogue and digital input and output. No such commercial devices exist, which can operate in the hostile environment in the cavern. Also because of cost — several 100,000 channels are needed — and space limitation an optimised design was required.

The ELMB is a single, credit card sized electronics board which may either be embedded into custom front-end equipment or be used in stand-alone mode. It comprises 64 high-precision analog input channels of 16-bit accuracy and it provides 8 digital input, 8 digital output and 8 configurable (either input or output) lines. Its serial port can drive additional devices like a digital-to-analogue converter. As it has very low power consumption, it can be powered from the electronics rooms via the fieldbus cable.

The firmware loaded into the ELMB includes both driving the input/output functions and the communication over the CAN field bus using the higher level protocol CANopen. Standard configuration software tools provide easy ‘plug and play’ functionality for the user. The ELMB fulfils the majority of standard I/O requirements of the ATLAS subdetector applications in terms of functionality, accuracy, and stability. It has been tested and qualified to operate in the radiation and magnetic field environment in UX15. Its error detection and recovery procedures have been proven in long term operations without manual intervention.

Typical applications of the ELMB are to directly read/write sensors and actuators or to control more complex devices like power supplies, gas devices, cooling systems, or whole detector elements like chambers. In the second class of applications, the ELMB is normally fully integrated in the device. In several cases specialised ELMB software has been developed by the user, which replaces its standard firmware.

### 11.3.2 Other FE equipment

An effort is made to standardise FE devices like high voltage units, low voltage power supplies, racks, PLCs etc. As all four LHC experiments have similar requirements, such front-end equipment will be supported in the frame of ICOP. This includes generic tools and libraries for configuration, data read-out into the SCADA, and general supervision and operation. The gas systems fall also in this category of equipment.

Specialised, non-standard FE equipment like alignment and calibration systems is usually self-contained. Often large quantities of data have to be read and to be processed. The results are then transmitted to DCS for further treatment, monitoring and storage. Therefore for each such system a connection point and a protocol has to be defined. This is in many cases TCP/IP over a LAN, but also dedicated drivers running in the BE will be used.

## 11.4 The Back-End system

The functionality of the BE system is two-fold: It acquires the data from the FE equipment and it offers supervisory control functions, such as data processing and analysis, display, storage and archiving. It also provides handling of commands, messages and alarms.

The BE system is organized hierarchically to map the natural structure of the experiment into subdetectors, systems and subsystems. The BE hierarchy allows the dynamic splitting of the experiment into independent partitions as defined in Section 3.4, which can be operated in stand-alone or integrated mode. The operation of the different subdetectors will be performed by means of Finite State Machines (FSM), which will handle the states and transitions of the different parts of the DCS. The coordination of the different partitions will be performed by means of commands and messages. The command flow is downwards, whereas the message exchange takes place in either vertical direction within a partition. Horizontal communication is normally not needed.

### 11.4.1 Functional hierarchy

In order to provide the required functionality, the BE of the DCS will be organized functionally in three levels as shown in Figure 11-2. Overall operation of the detector can be performed at the level of the Global Control Station (GCS), while data processing and command execution are handed at the lower levels. Archiving of data and alarms and logging of commands and incidents will be provided at every level. Remote access to a well-defined set of actions to be performed by the two upper levels of the BE hierarchy will also be provided subject to proper access authorization.

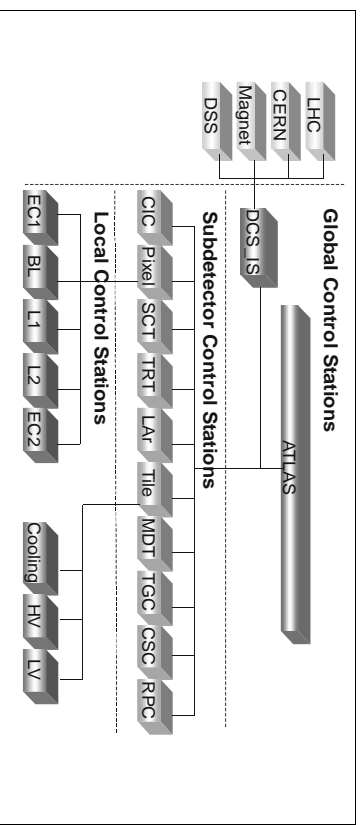

Figure 11-2 Hierarchical organization of the Back-End system of the DCS in three functional layers

## Global Control Stations

The overall control of the detector will be performed at the top level of the BE system, which consists of the Global Control Stations. They provide high level monitoring and control of all subdetectors and of the technical infrastructure. Detailed control of the subdetectors is provided only at the next lower level. The functions performed by the GCS are the following. They assemble all status information available and present it to the operator in a hierarchical fashion. All anomalies of operation like warnings, alarms etc. are collected, displayed and archived. Actions from the operator like acknowledgements can be requested. The GCS may trigger actions themselves or ask the operator to do so. Any parameter in the system can be inspected at real-time and its history can be displayed. This also includes browsing of log files. Pre-defined commands can be given to the subdetectors and to their subsystem. Settings can be changed for selected parameters. The DCS Information Service (DCS\_IS) handles the communication with external systems like the LHC accelerator, the CERN infrastructure, the magnets, and the Detector Safety System. Web access and database services will be handled by dedicated servers. Bidirectional data exchange between the DCS and the TDAQ system will be possible at this level but commands from TDAQ will only be sent to the level below.

### Subdetector Control Stations

The Subdetector Control Stations (SCS) form the middle level of the BE hierarchy. There will be one SCS per subdetector and an additional SCS to handle the monitoring of the common infrastructure of the experiment, the CIC. The latter will be directly interfaced with the DCS\_IS in the level above. All actions on a given subdetector which are possible from the Global Control Stations are provided at this level as well. In addition, the SCS allows the full, local operation of the subdetector by means of dedicated graphical interfaces. The SCS also handles the communication with the services of the layer above. It is foreseen to have a direct connection from the SCS to the DCS\_IS to provide the different SCS with the status of the external systems, as well as with the environmental parameters of the common infrastructure. The SCS handle the co-ordination of all subsystems in the layer below and they are responsible for the validation of all commands, which are issued either by the GCS or from the TDAQ run control. They translate global commands like to ramp up a high voltage system into detailed commands e.g. for the individual power supplies and send these to the level below for execution. They assemble the overall status of the subdetector and pass it on to the GCS and to TDAQ. Parameters can be archived and commands and incidents can be logged.

### Local Control Stations

The bottom level of the BE hierarchy is constituted by the Local Control Stations (LCS), which handle the low level monitoring and control of the different systems and services of the detector. The organization of this level for a given subdetector can be according to either geographical or functional criteria. The former follows the topological composition of the subdetector in e.g. barrel, end-cap etc., whereas the latter combines functions or services of the subdetector, like cooling, high-voltage, etc. in one LCS. This level of the hierarchy is directly interfaced to the FE system. Besides the read-out and control of the equipment, it also performs calculations and fine calibration of the raw data from the FE and comparison of the values with preconfigured thresholds for the alarm handling. The stations placed at this level will execute the commands received from the SCS in the layer above and they can also execute autonomously predefined actions if required.

## 11.4.2 SCADA

SCADA systems are commercial software packages normally used for the supervision of industrial installations. They gather information from the process control layer, process these data and present them to the operator.

Besides the basic functionalities like Human Machine Interface (HMI), alarm handling, archiving, trending or access control, SCADA products also provide a set of interfaces to hardware, e.g. fieldbuses and PLCs, and to software, e.g. Application Program Interface (API) to communicate with external applications, or connectivity to external data bases via the Open or Java Data Base Connectivity (OJDBC and JDBC respectively) protocols.

SCADA products provide a standard framework for developing applications and lead in this way to a homogeneous DCS. This saves also development and maintenance effort reducing the work for the subdetector teams. In addition, they follow the evolution of the market, allowing to profit from the advancements in technology like operating system or processor platforms.

### 11.4.3 PVSS-II

A major evaluation exercise of SCADA products [11-5] was performed at CERN in the framework of ICOP, which concluded with the selection of PVSS-II [11-6] from the company ETM. This product will be used for the implementation of the BE systems of the four LHC experiments.

PVSS-II is device-oriented, where process variables that belong logically together are combined in hierarchically structured data-points. Device-oriented products adopt many properties like inheritance and instantiation from object-oriented programming languages. These features facilitate the partitioning and scalability of the application. PVSS-II includes a powerful API. A driver development toolkit is also available to interface to custom applications or special equipment.

PVSS-II is designed as a distributed system. The single tasks are performed by special program modules called managers. The communication among them takes place according to the client-server principle, using the TCP/IP protocol. The internal communication mechanism of the product is entirely event-driven. This characteristic makes PVSS-II specially appropriate for detector control since systems which poll data values and status at fixed intervals, present too big an overhead and have too long reaction times resulting in lack of performance.

The managers can be distributed over different PCs running either Microsoft Windows or Linux. The communication between them is internally handled by PVSS-II. This has been an important point in the selection of this product since the DAQ system of the ATLAS experiment is being developed entirely under Linux.

PVSS-II allows to split the supervisory software into smaller applications communicating over the network as it is imposed by the distribution of the DCS equipment over different locations.

### 11.4.4 PVSS-II framework

PVSS-II has proven to be a good basis to build the LHC experiment controls. It misses however some functionality required for controlling high energy physics detectors and some generic

tools and libraries are needed to develop an homogeneous and coherent system. Therefore an engineering framework on top of PVSS-II is being developed in the context of JCOP. This comprises a set of guidelines, tools, libraries and components needed by all four LHC experiments. This framework will lead to a significant reduction in the development and maintenance work to be done by the subdetector teams and to a more homogeneous system. It also addresses questions of interoperability of the different components.

This framework includes programs to create the read-out structure for standardized devices such as high voltage systems and to configure them. Operational tools for displaying data or alarms are also in its scope, as well as drivers to connect commonly used hardware and software.

The ELMB has been integrated into PVSS as a component of the JCOP framework in order to facilitate the usability of the ELMB and to ensure the homogeneity of the SCADA software. The ELMB component provides all PVSS infrastructure needed to set up and to operate the ELMB. It also comprises a so-called 'top-down' configuration tool, which handles the configuration of the software interface of the ELMB to the BE.

Some services, tools and even applications can be common for all PVSS-II stations in the BE. Examples are access to the conditions data base, advanced data display, or the alarm system. These are also expected to be provided by this framework.

## 11.5 Integration of Front-end and Back-end

Several methods are possible for the connection between the BE and the FE systems:

- Dedicated driver: PVSS-II provides drivers for modbus devices, PROFIBUS and some other hardware. It also contains a driver development toolkit which allows users to write a driver for their special hardware.
- OPC client-server connection: OPC [11-7], which is the abbreviation for 'Object linking and embedding for Process Control', is a widely used industrial standard. Most commercial Low and High voltage systems are supplied with an OPC server.
- DIM software: DIM, which is the abbreviation for 'Distributed Information Manager' has been developed at CERN. It is a communication system for distributed and multi-platform environments and provides a network transparent inter-process communication layer.

Due to its wide spread usage and the good industrial support, OPC has been chosen as the main interface from the SCADA to hardware devices. The main purpose of this standard is to provide the mechanism for communicating with numerous data sources. OPC is based on the DCOM technology of Microsoft and hence requires the Windows operating system. The specification of this standard describes the OPC Objects and their interfaces implemented by the OPC server. The architecture and specification of the interface was designed to facilitate clients interfacing to remote server. An OPC client can connect to more than one OPC Server. In turn an OPC Server can serve several OPC clients. Consequently all OPC objects are accessed through interfaces.

### 11.5.1 OPC CANopen server

CANopen, which is used by the ELMB, is a high level protocol for the CAN-bus communication. This protocol is widely used as well. CANopen standardizes the types of CAN-bus messages and defines the meaning of them. It allows to use the same software for managing CAN nodes of different types and from different manufacturers. Several CANopen servers exist on the commercial market. But all of them are tailored to specific hardware interface cards and they provide only a subset of the CANopen functionality required by the ELMB. For these reasons, an OPC CANopen server has been developed to connect the ELMB to SCADA.

This OPC CANopen server works as the CANopen master of the bus, handling network management tasks, node configuration and data transmission to the OPC client. It consists of two parts.

- The main part contains the OPC functions proper. It implements all the OPC interfaces and main loops. Any application interacts with this part through interfaces. The CANopen OPC server transmits data to a client only on change, which results in a substantial reduction of data traffic.
- The second part is hardware dependent. It communicates with the CAN bus driver of the CAN interface card chosen and controls the CANopen devices.

Several buses with up to 127 nodes each, in accordance with the CANopen protocol, can be operated by this OPC CANopen server. The system topology in terms of networks and nodes per bus is modelled at start up time in the address space of the OPC CANopen server from a configuration file, which is created by the ELMB configuration tool mentioned in Section 11.4.4.

### 11.6 Read-out chain

The complete standard read-out chain [11-8] ranges from the I/O point, e.g. sensor or actuator, to the operator interface and is composed of the elements described above: ELMB, CANopen OPC Server and PVSS-II. In addition to the data transfer, it also comprises tools to manage the configuration and the settings and status of the bus. PVSS-II models the system topology in terms of CANbus, ELMB and sensor in its internal database by data-points. These data-points are connected to the corresponding items in the OPC server in order to send the appropriate CANopen message to the bus. In turn, when an ELMB sends a CANopen frame to the bus, the OPC server decodes it and sets the respective item in its address space, which transmits the information to a data-point in PVSS. The different elements of the read-out chain perform the functions described below.

The ELMB digitises the analogue inputs and drives the digital input and output lines. Different settings can be applied to the ADC, including choosing as data output format either raw counts or calibrated micro-Volts. Data are sent either on request from the supervisor, or at predefined intervals, or when they have changed. As the ELMB is in most cases exposed to ionizing radiation, its firmware checks also for possible radiation-induced errors (e.g. memory or register changes) and tries to correct them.

The OPC server transmits data together with quality information as soon as they have changed. It can optionally perform calculations, e.g. converting the data into physical quantities in appropriate units.

The SCADA system applies the individual calibration procedures and compares the data with pre-defined thresholds. In this way warnings, alarms, and automatic actions are established. The SCADA also archives the data and allows their visualisation.

### 11.6.1 Performance of the DCS readout chain

To investigate the performance and the scalability of the DCS read-out chain up to the size required by ATLAS, a CANbus system consisting of 6 CANbuses with 32 ELMBs each was set up [11-8].

The aim was to study the behaviour of the system in order to optimise the read-out parameters and to find the performance limits of such a read-out chain. These limits define the granularity of the system in terms of number of ELMB per CANbus and the number of buses per PVSS system. In particular, the following was investigated:

- Remote powering of the ELMB nodes via the bus. The radiation levels in the detector cavern force the power supplies to be placed in the underground electronics rooms. Therefore, the power for the nodes will have to be fed remotely via the CANbus with distances up to 150 m.
- Bus load, which determines the number of nodes per bus. The data traffic on the bus has to be uniformly distributed over time in order to keep the bus load low under normal operation. In ATLAS the bus occupancy should be kept well below 60%, even during peak times.
- Optimization of the work balance amongst the different processing elements in the read-out chain. The functions to be performed by the ELMB, CANopen OPC server and PVSS have to be evenly distributed to ensure adequate load of each of these components and to avoid bottle-necks.
- Optimization of the system performance by tuning the different software settings such as update rates for OPC and the read-out frequency.
- Determination of the overall read-out speed.

The setup employed in the test is shown in Figure 11-3. The system of CANbuses was operated from PVSS-II using the CANOpen OPC server and a CAN interface from the company Kvaser [11-9], which is the choice for final ATLAS. The bus lengths were 350m in all cases, in order to fulfil the ATLAS requirements with a broad margin. Up to 32 ELMBs were connected at the end of each CANbus. The total number of channels in this system was 12288 analog inputs, 3072 digital outputs, and 1536 digital inputs. It is important to note that the number of channels in the set up described here is comparable to some large applications in ATLAS. During the test, the read-out rate was increased in order to push the system to the limit. When big bursts of data arrive at PVSS-II very rapidly, the different messages can be internally buffered. Two different situations can be distinguished:

- 'Steady run', where all messages sent by the ELMBs to the bus are stored to the PVSS-II database and are processed in real time, i.e. no buffering takes place at the PVSS-II or OPC level.
- 'Avalanche run', where the fastest possible read-out rate is maintained for a certain period of time, typically a few minutes. Under these circumstances, although all messages are archived to the PVSS database, the data flow is so high, that messages cannot be treated in real time. They are buffered at the SCADA level, leading to an increase in the memory us-

age. It is important to note that although long term operation under these conditions would not be possible, such a situation can occur in case of major problems of the equipment monitored, like power cuts, when all parameters change at the same time. The read-out system must be able to handle this for a short period of time and to recover from it.

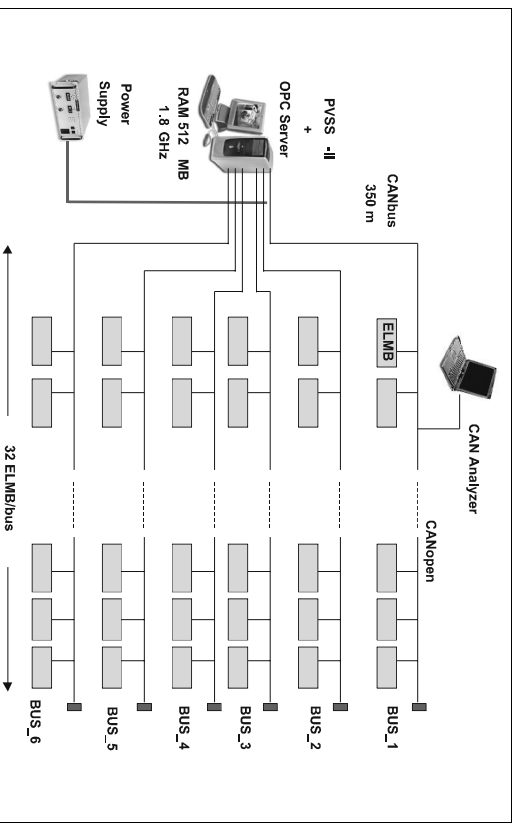

Figure 11-3 ELMB full branch test setup. (To be changed: Show bus multiplicity)

For the system described, a read-out of 30s was measured in order to meet the conditions of a 'steady run'. When allowing buffering, i.e. an 'avalanche run', a full read-out cycle could be done every 8s for several minutes. The examination of the CPU usage showed that in both cases the limitation is the CPU work load due to the PVSS-II managers. These results indicate that the operation of the read-out is constrained by the performance of PVSS-II. It has to be pointed out, that the situation described is the worst case possible. During normal operation data will be sent only when they change, i.e. they are even distributed over time, and can be treated in real time.

### 11.6.2 Long term operation of the read-out chain

The DCS has to operate without any interruption and must hence recover automatically from any errors, including those induced by radiation. The long-term operation of the full read-out chain was tested with a number of ELMBs in a radiation environment similar in composition to the one expected in the ATLAS cavern, though at a much greater dose rate [11-10]. This environment allows to test the various error recovery procedures implemented at the different levels of the read-out. A CAN bus of more than 100 m was connected to a PC running the standard read-out chain. The test ran permanently for more than two months, which is equivalent to about 300 years of operation of an ELMB at the expected ATLAS dose rate. The following precautions and recovery procedures are implemented. The CAN controller in the ELMB ensures that messages

are sent correctly to the bus and will take any necessary action if errors are detected. Bit flips, which were observed at the ELMB by special test software, were also handled correctly by the ELMB firmware. The OPC server ensures that all ELMBs on a bus are kept in the operational state by monitoring all messages and sending a software reset when required. At the highest level, PVSS scripts were utilized to detect an increase of the current consumption of the bus, which would be an indication for damage by radiation and to reset ELMBs if communication was lost. Through this script the power supply for the bus was also controlled allowing for hardware resets by cycling the power. The system ran stably without any user intervention for the total time of the test.

## 11.7 Applications

The components and tools described above are used to build the applications, which control and monitor the experiment equipment. The applications for the supervision of the subdetectors are the responsibility of the subdetector groups and are described in the relevant TDRs and in [11-12]. All equipment, which does not belong directly to a subdetector will be supervised by the SCS of the CIC, which is hierarchically situated at the level of a subdetector. It monitors the subsystems described below.

All racks, both in the electronics rooms and in the cavern will contain a control unit based on the ELMB. It monitors the basic operational parameters like temperatures, air flow, cooling parameters, etc. and also user-defined parameters. Some racks will have the option of controlling the electric power distribution. The crates which are housed in these racks usually have their own controls interface.

General environmental parameters like temperature, humidity, pressure, radiation level etc. will also be monitored by the CIC. Parameters of the primary cooling system also belong to this category. The individual subdetector cooling distribution systems however are supervised by the corresponding subdetector SCS.

All information collected is available to all other PVSS stations via the central DCS information server. A subset of it will also be transmitted to the DAQ.

## 11.8 Connection to DAQ

In order to enable coherent operation and synchronisation between DCS and DAQ, communication between these systems with the following functionality is provided:

- Bi-directional exchange of data, e.g. parameter values and status information
- Transmission of DCS messages to DAQ, e.g. alarms and error messages
- Sending of commands from DAQ to DCS and providing feedback about their execution

Following the concept of partitioning in DAQ the communication functionality required has to be provided for each TDAQ partition individually, independent from other partitions.

The TDAQ Online software package, described in the previous chapter, provides a series of services for TDAQ for inter-application communications. These are the Information Service which allows to share the run time information, the Error Reporting Service, which distributes

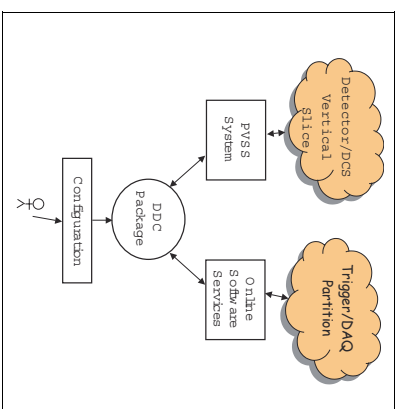

Figure 11-4 DDC package connecting DCS and DAQ

application messages and the Run Control package, which uses an FSM to represent, control and synchronize the states of TDAQ subsystems of a partition. These services are used on the DAQ side for the communication with DCS.

PVSS-II is provided with a powerful API allowing full direct network access to the PVSS-II run time database. This API is on the DCS side the low-level interface for the communication between DAQ and DCS.

The DAQ-DCS Communication package (DDC) [11-13] is developed on top of the interfaces mentioned above as a generic tool configurable by end-user (fig.11-4). The following describes the DDC software components with their interfaces. Common features are:

- Implemented as a PVSS-II API manager, integrating the program interface of the corresponding Online software service
- Wait for connection, when a communication partner is temporarily unavailable
- Re-establish interrupted connection
- Configuration from the TDAQ configuration database

The prototype of the DDC package has been used in the test beam periods of 2001 and 2002 and has been demonstrated to work in a satisfactory and reliable manner.

### 11.8.1 Data transfer facility (DDC-DT)

The data exchange in both directions is implemented via the Information Service of the DAQ Online software. The application keeps the data elements, i.e. the parameters of the systems, which are declared in the DDC-DT configuration, synchronized at both sides. This is implemented by a subscription mechanism which is available for DAQ and DCS. The possibility for DAQ to request a single read of specified DCS data is also provided. Figure 11-5 shows the interfaces being used.

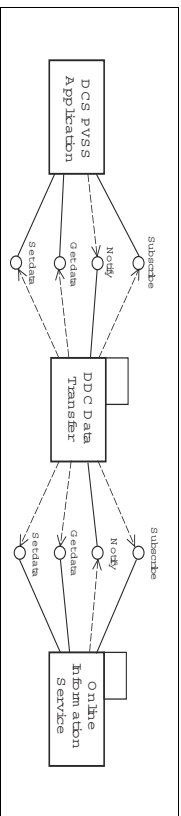

Figure 11-5 DDC data transfer interfaces.

### 11.8.2 Message transfer facility (DDC-MT)

The DCS message transfer to DAQ is implemented via the Error Reporting System of DAQ. The interfaces used are shown in Figure 11-6. DCS messages like alarms or text variable as defined in the configuration are transported to DAQ by this component.

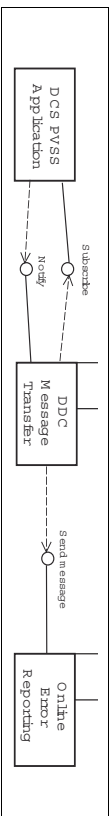

Figure 11-6 DDC message transfer interfaces.

### 11.8.3 Command transfer facility (DDC-CT)

The DDC-CT subsystem, shown in Figure 11-7, is implemented as a dedicated run controller to be included as a leaf in a TDAQ partition run control tree. This run controller, like any other TDAQ run controller, is capable of executing standard commands and triggering transitions as defined by the FSM of the TDAQ partition. In addition it allows sending so-called 'non-transition' commands to DCS via the Online software Information Service.

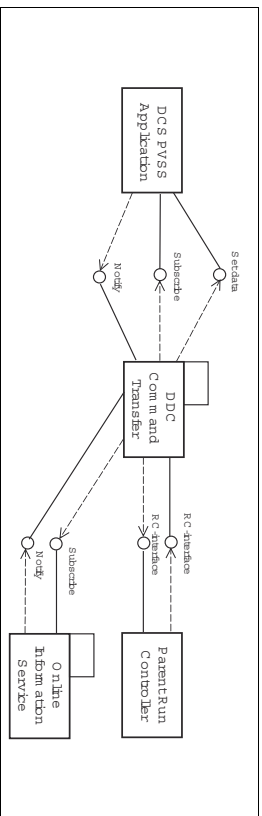

Figure 11-7 DDC command transfer interfaces.

The term non-transition indicates, that those commands do not cause any FSM transition of the DDC-CT controller. Such a command may be issued at any time by any TDAQ application, including the parent run controller.

The format and meaning of the commands is defined in the PVSS-II application. The mapping of the run control transitions onto commands for DCS is done in the DDC-CT configuration.

### 11.9 Interface to External Systems

The term external system designates systems which have their own control system, with which ATLAS has to interact. This communication will be handled by the DCS. The most notable example of such a system is the LHC accelerator.

The connection will support bi-directional information exchange and in some cases include sending and receiving of commands. This interface will be common for the four LHC experiments and it is expected to be developed in the framework of ICOP.

#### 11.9.1 LHC

Data have to be transmitted between ATLAS and the LHC accelerator in either direction. The following are examples of data, which the LHC has to provide to ATLAS:

- overall status of the accelerator, e.g. shutdown, filling, ramping, tuning, stable beams
- beam parameters, e.g. energy, the different types of background, luminosities, beam positions, beam sizes and profiles
- ancillary parameters, e.g. collimator settings, magnet settings and vacuum values upstream and downstream of the experiment

This information is used in ATLAS for validation of commands on the subdetectors, for interlocks, for the operation of physics data taking as described in Section 12.5, and eventually also for the offline physics analysis. These data will be logged by DCS.

Examples of data that ATLAS will send LHC are:

- various types and distribution of backgrounds as observed in the subdetectors
- luminosities measured and several trigger rates
- beam positions measured by the ATLAS tracking subdetectors
- magnet status, as especially the solenoid may have an effect on the beams
- permission to inject particles or to dump the beam, as the subdetectors have to be in a state which is safe for these operations

This information is needed for the operation of the accelerator, in particular for the fine-tuning and optimization of the beams.

A complete list of all parameters to be exchanged is not yet available to date. In particular, whether individual bunch information, will be transmitted in this way, is not decided. Although the exchange of many of these parameters is only needed during data-taking, a subset of this information, like the backgrounds and radiation doses is needed for periods like machine development. This information is required regardless of the state ATLAS is in. This is one main reason why this communication will be handled by the DCS on the ATLAS side and not by the DAQ system.

### 11.9.2 Magnet system

It has been decided, that all magnet systems of the four LHC experiments will be controlled by the tools selected for the LHC magnets and cryogenics. Therefore the ATLAS magnets are considered by DCS as an external system. However information exchange is foreseen in the same way as for the LHC accelerator, but no actions. The operational data from the ATLAS magnets will be analysed, displayed and stored by DCS like any subdetector parameter.

### 11.9.3 CERN technical services

The technical services around the ATLAS detector include cooling, ventilation, electricity distribution, environmental radiation monitoring, the CERN safety system, etc. ATLAS needs access to some parameters of these services to ensure safe operating conditions for the subdetectors. In particular it is essential to get early indications of problems with services like cooling. In such cases DCS can take precautions in order to avoid possible damage to the detectors. In some cases also automatic feedback from ATLAS about it needs and usage of the service may be required.

### 11.9.4 Detector Safety System

As previously mentioned, the DCS is responsible neither for the security of the personal nor for the ultimate safety of the equipment. The former is the responsibility of the LHC-wide hazard detection systems, whereas the latter has to be guaranteed by hardware interlocks internal to the subdetectors and by the Detector Safety System [11-14]. One of the main purposes of DSS is to provide the correlation amongst the subdetectors and the experimental infrastructure as far as safety is concerned. DSS consists of a front-end system with stand-alone capability, which is based on PLCs. A BE system, implemented by PVSS-II, provides supervisory functions, but it is not needed for the real-time operation. Bi-directional information exchange between the DCS and the DSS is provided on the PVSS-II level. Actions are triggered only in one direction, from DSS to DCS. In this way, the DCS can not disturb the operation of the safety system, but early information about minor problems, that the DSS may detect, enables DCS to take corrective actions or to shut down the problematic part of the detector before the problem escalates and DSS has to take a higher level action.

## 11.10 References

- 11-1 A.Daneels and W.Salter, "The LHC experiments Joint Controls Project, ICOP", ICALPECS, Trieste, Italy, 1999
- 11-2 M.Dentani, "ATLAS policy on radiation tolerant electronics", CERN, ATC-TE-QA-0001, 2000
- 11-3 CAN in Automation (CIA), <http://www.can-cha.de>
- 11-4 B.Hallgren et al., "The Embedded Local Monitor Board (ELMB) in the LHC Front-End I/O Control System", 7th Workshop on Electronics for LHC Experiments, September 2001, Stockholm (Sweden)

- 11-5 A. Daneels and W.Salter, Selection and evaluation of commercial SCADA systems for the controls of the CERN LHC experiments, ICALPECS, Trieste, Italy, 1999
- 11-6 PVSS-II, <http://www.pvss.com>
- 11-7 OLE for Process Control, <http://www.opcfoundation.org/>
- 11-8 H.L. Burchhart et al., Vertical Slice of the ATLAS Detector Control System, submitted to 7th Workshop on Electronics for LHC Experiments, September 2001, Stockholm (Sweden)
- 11-9 F. Varela Rodriguez, Systems of ELMB Buses using the Kvaser PCI CAN card, CERN ATLAS DCS-IW/N17 (2002)  
<http://www.kvaser.com>
- 11-10 H. Boterenbrood et al., Results of radiation tests of the E at the CERN TCC2 area, CERN ATLAS DCS-IW/N16, 2002
- 11-12 F. Varela Rodriguez, The Detector Control System of the ATLAS experiment: An application to the calibration of the modules of the Tile Hadron Calorimeter, Ph.D. Thesis, CERN-THESIS-2002-035 (2002)
- 11-13 H.L. Burchhart et al., Communication between Trigger/DAQ and DCS in ATLAS, Proceedings on the Computing in High Energy and Nuclear Physics Conference, China, 2001.
- 11-14 S.M. Schmeling, G. Morpurgo, St. Luders and B. Flockhart, The Detector Safety System for LHC Experiments, Presented at the XIII IEEE-NPSS Real Time Conference 2003, Canada 2003



## 12 Experiment Control

### 12.1 Introduction

The overall control of the ATLAS experiment includes the monitoring and control of the operational parameters of the detector and of the experiment infrastructure, as well as the supervision of all processes involved in the event readout. This functionality is provided by two independent although complementary and interacting systems: the TDAQ control and the Detector Control System. Although DCS is formally part of TDAQ, its functionality has been logically separated here in the description of the experiment control. The TDAQ Control is in charge of controlling the hardware and software elements in TDAQ needed for data taking. The DCS handles the control of the detector equipment and related infrastructure. The architecture of the overall system has already been discussed in Section 5.3. The DCS is based on a SCADA system PVSS-II [12-1], whereas the TDAQ control is based on the TDAQ Online Software described in Chapter 10. These systems perform different tasks and have different requirements. Whilst the TDAQ control is only required when taking data, the DCS has to operate continuously to ensure the safe operation of the detector. The operation of the detector requires a high degree of coordination between these two systems and with the LHC machine. The interaction with the LHC machine will be handled by the DCS as illustrated in Figure 5-3 and presented in detail in Chapter 11. The TDAQ system is in overall control of data-taking operations.

The general control of the experiment requires a flexible partitioning concept as it is described in Section 3.5, which allows for the operation of the sub-detectors in stand-alone mode, as required for calibration or debugging, as well as for the integrated operation for concurrent data taking. The overall control strategy and the control operations of the various systems are described in this chapter. Furthermore, the required coordination of the various systems involved in the scenarios for physics data-taking and calibration modes, is discussed.

### 12.2 Detector control

The DCS system provides the flexibility to implement the partitioning concept of ATLAS. The finest granularity of the TDAQ system is given by the segmentation of the sub-detectors into TTC zones [12-2] [12-3]. For this reason, the different sections of the sub-detectors will be logically represented in the back-end software of the DCS, presented in Section 11.4, by means of the control units, which will be operated as a Finite State Machine (FSM). A logical control unit models the behaviour of a sub-detector or a system, e.g. the Pixel sub-detector or the high voltage system. Each control unit is characterized by its state. The control units are hierarchically organized in a tree-like structure to reproduce the organization of the experiment in sub-detectors, sub-systems, etc. as illustrated in Figure 12-1. The units may control a sub-tree consisting of other control or device units. The device units are responsible for the direct monitoring and control of the equipment, i.e. they represent hardware devices like a high voltage crate or a temperature sensor. According to this model, the DCS of the Tileal, for example, may be described by a tree of logical control units: the root logical unit controls the sub-detector itself and four independent child units, which control the four sub-detector sections (two extended barrels, EB+ and EB-, and the central barrel sections, B+ and B-). The sub-detector control units are in charge of supervising the various device units. Each control unit has the capability to exchange information or pass commands to other control units in the hierarchy. The flow of com-

mands and information will only be vertical. Commands will flow downwards, whereas status and alarms will be transferred upwards in the hierarchy.

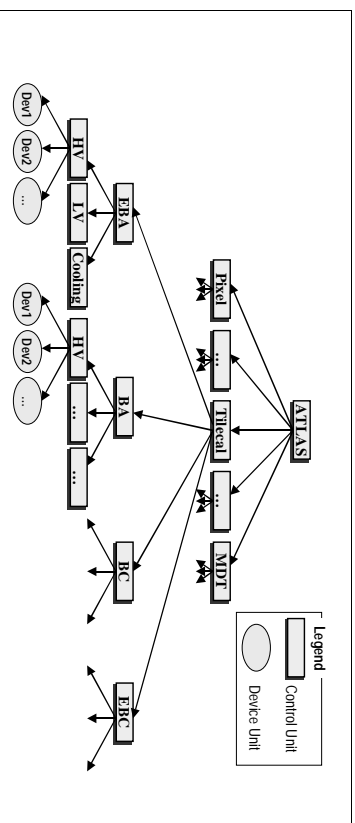

Figure 12-1 DCS Logical Architecture

The control units will support different partitioning modes. Any control unit and therefore, the related sub-tree, may be excluded from the hierarchy and be operated in stand-alone mode for testing, calibrations or debugging of part of the system. In this case the detector can be operated directly from the DCS control, whereas during physics data taking and calibration procedures, commands will be sent from the TDAQ control. Therefore, a priority scheme, which avoids the possibility of issuing conflicting commands must be provided. This mechanism will be developed according to the recommendations of the JCOP Architecture Working Group [12-4].

### 12.3 TDAQ Control

The TDAQ system is composed of a large number of hardware and software components, which have to operate in a coordinated fashion to provide for the data-taking functionality of the overall system. The organisation of the ATLAS detector into detectors and sub-detectors leads to a hierarchical organisation of the control system. The basis of the TDAQ control is provided by the Online Software, which is explained in detail in Section 10.5.

The basic element for the control and supervision is a controller. The TDAQ control system is comprised of a large number of controllers which are distributed in a hierarchical tree following the functional composition of the TDAQ system.

This hierarchy is illustrated in Figure 12-2. Four principle levels of control are shown. Additional levels can be added at any point in the hierarchy if needed. A top level controller named the root controller has the overall control over the TDAQ system. It supervises the next level of controllers in the hierarchy, the sub-detector controllers. It is the responsibility of the sub-detector controller to supervise the hardware and software components which belong to this sub-detector.

The next control level takes the responsibility for the supervision of the sections which correspond to the TTC partitions [12-5]. The leaf controllers on the lowest level, the so-called local controllers, are responsible for the control of physical hardware such as ROSs. All elements of the TDAQ system (e.g. ROSs, HLT farms etc.) employ the same type of controllers, and follow a similar structure, as discussed in Section 12.3.1 and Section 12.3.2.

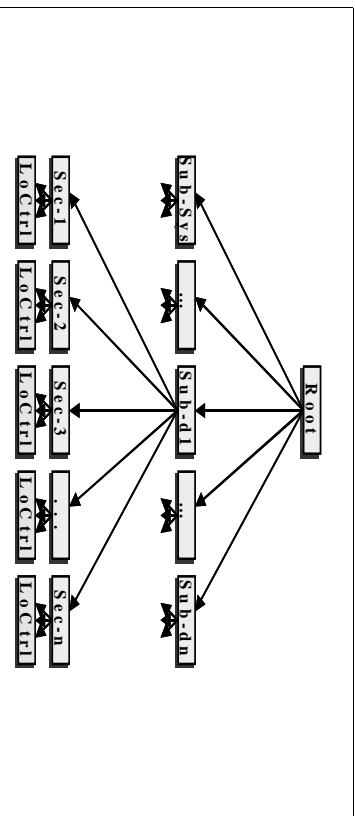

Figure 12-2 Online Software Control Hierarchy in ATLAS

A controller in the TDAQ system is characterized by its state (e.g. Running, Paused, Stopped etc.) given by the TDAQ state model described in Section 12.4.3. In any place of the hierarchy, a change of state may be initiated and synchronized from a given level of controller and sent down to the next lowest level. Once the requested transition has been performed, status information is returned to the requesting controller. Possible error conditions are also reported back.

A controller framework provides the facilities to handle the described operations in a coherent way on all the controllers in the system. It also gives the necessary flexibility to the detector expert to customize each controller for handling the individual tasks on the system under its control. These tasks may vary widely from initializing hardware readout to EP farm control. The information on the inter-relationship of the controllers and their responsibilities for a given partition is detailed in the configuration database (Section 10.4.3).

Each controller is responsible for the initialisation and the shutdown of software and hardware components in its domain. It is also responsible for passing commands to child controllers (controllers under its control) and for signalling its overall state to its parent. Of particular importance is the synchronisation necessary to start data-taking operations. This is performed by consecutive coordinated transitions through a number of intermediate states until data-taking is finally started as described below in Section 12.5.1. The shift operator drives the operations by issuing commands to the root controller. The inverse series of transitions is traversed when data-taking is stopped.

During the operational phases, each controller is responsible for the supervision of the operation of elements under its direct control and for monitoring and handling any error conditions. In the case of a malfunction of e.g. a detector, the controller can start corrective actions and/or signal the malfunction by issuing error messages. Severe malfunctions which are beyond the capabilities of a controller can be signalled by a state change to its parent (e.g. moving from a Run-

ning state to a Paused state). It is then the role of the parent controller to take further actions depending on the circumstances of the malfunction.

The design of the control, supervision and error handling functions is based on the use of a common expert system. Specific controllers will use dedicated rules (information which tells the controllers what to do in one of many defined situations) to perform their individual functions in addition to common rules which handle more general situations.

### 12.3.1 Control of the DataFlow

The DataFlow control handles all applications and hardware modules responsible for moving the event data from the detector front-end electronics and LV1/L1 trigger to the HLT system. It includes the control of the ROB, the ROS, the Event Building and the SFOs. It also includes the overall control of the detector ROD crates.

There are two types of local DataFlow controllers foreseen, both making use of the Online software infrastructure in the same way, as shown in Figure 12-2. The ROS controller is tailored for the control of ROS software applications and hardware devices which do not themselves access the online software facilities. The Data Collection (DC) controller handles all other DataFlow applications and is optimized for the control of collection of processors. A version of the latter is also used for the control and supervision of the HLT and is described in Section 12.3.2. The other type, the ROD crate controller, takes over the communication handling between the other Online software services, Information Sharing and Configuration Databases, and the hardware which it controls.

Both controllers can be deployed at different levels of the control hierarchy. As an example, a DC controller can be used as top controller for all event building applications, as well as a controller for a group of them. The DataFlow controllers request information on the elements they supervise from the configuration database. Their function is to initialize, configure, start, pause and stop the hardware and software data taking elements, to monitor the correct functioning of the system, to gather operational statistics information and to perform local error handling for those kinds of errors which cannot be handled locally, but do not need to be propagated further to higher control levels.

### 12.3.2 HLT farm supervision

The emphasis for HLT farm supervision is the synchronisation and control of the HLT farms (LV1/2 and EF) with that of the other TDAQ systems. An HLT farm is comprised of a set of sub-farms, each under supervision of a specific controller, as shown in Figure 12-3. These controllers have well defined tasks in the control for the underlying processes running on the sub-farms.

A key overall design principle of the HLT has been to make the boundary between LV1/2 and EF as flexible as possible in order to allow the system to be adapted easily to changes in the running environment (luminosity, background conditions, etc.). Therefore a joint control and supervision system for the two sub-systems has been designed and developed.

The configuration database contains data describing the software processes and hardware (processing nodes) of which the HLT is comprised as well as a wide variety of set-up and configuration data for pre-defined data-taking scenarios. The HLT supervision and control system uses these data to determine which processes need to be started on which hardware and sub-

quently monitored and controlled. The smallest set of HLT elements which can be configured and controlled independently is the sub-farm. This allows sub-farms to be dynamically included/excluded from partitions during data-taking without stopping the run. Dedicated local run controllers supervise and control each HLT sub-farm, and report to an overall farm controller. This in turn condenses the information coming from each sub-farm and reports the global state of the farm (LV12 farm or EF farm) to the run control. The controller also provides process management and monitoring facilities within the sub-farm. An expert system will guide the actions of the sub-farm controllers (e.g. spontaneously restarting crashed processes) such that it can maintain the sub-farm in the most efficient data-taking condition.

Where possible, errors are handled internally within the HLT processes. Only when they cannot be handled internally, errors are sent to the supervision and control system for further treatment.

The Online Software services are used by the supervision system for monitoring purposes. For example, IS will be used to store state and statistical information which can then be displayed to the operator or made available to other control elements (e.g. the malfunction of more than a pre-defined number of HLT sub-farms may precipitate the stopping of data-taking).

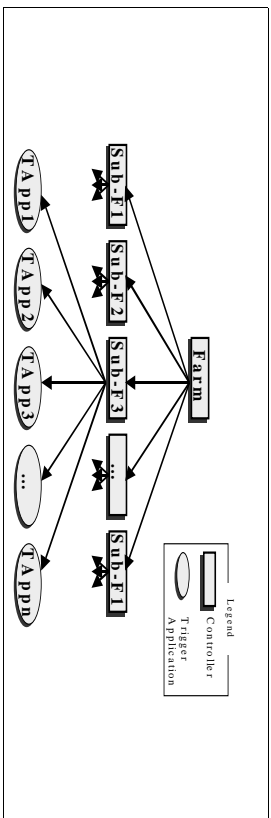

Figure 12-3 HLT farm control

## 12.4 Control coordination

The control of the experiment depends on the interplay between three systems: the LHC machine, the detector control and the TDAQ control. For each of them, their instantaneous status is expressed in terms of distinct logical states (e.g. Configured, Running, Stopped etc.). The states of a given system are highly correlated to those of other systems and only certain combinations of states are allowed at any given time. Some examples are given here:

- The LV11 trigger will not be started unless there are circulating beams in the LHC;
- The LV12 trigger will not be started if some parts of its configuration process failed;
- Physics data taking will not start if the detector high-voltage has failed.

The definition of these states, of their interplay, and of what actions are to be taken in what circumstances is a highly complex problem which will need the support of an advanced expert system.

### 12.4.1 Operation of the LHC machine

The phases of the LHC define a multitude of states required for the internal functioning of the machine. A sub-set is of direct interest for the interaction with the experiment control. In particular those states and parameters which describe the condition of the beam with consequences for the operation of the detector. Phases with stable beam and low background may indicate that it is safe to bring the detector to the operational state for physics data-taking, whereas abnormally high background conditions may dictate that the detectors are turned off for safety reasons.

The nominal main phases to consider for the LHC are the following:

- Filling — the beam is being transferred from the SPS into the LHC;
- Ramping — the beam is being accelerated up to its nominal energy;
- Squeezing — the beam is being prepared for physics;
- Collide — physics with stable beam;
- Dump, Ramp-down and Recover — restart states.

It will also be necessary to know if no beam is expected for a given time since these periods will be used by the experiment to perform maintenance and test operations. The estimated duration of these periods is also of importance since the actions to be taken on the detector equipment will vary, e.g. HV reduction for short machine interventions or shut down in case of major problems.

### 12.4.2 Detector states

As it has been presented in Section 12.2, the operation of the different sub-detectors will be controlled by means of FSMs. The FSM approach allows for sequencing and automation of operations and it supports different types of operators and ownership, as well as the different partitioning modes of the detector. The FSM will handle the transition of the different parts of the detector through internal states and, together with the use of an expert system, will be vital in the coherent operation of ATLAS.

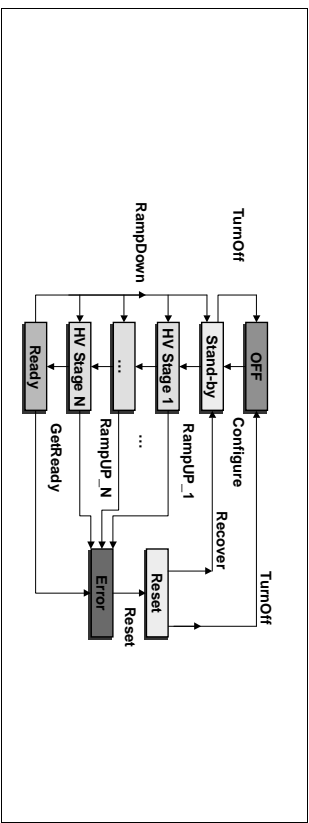

Figure 12-4 Detector states and transitions

Figure 12-4 shows an example of the internal HV states for a given sub-detector.

The sub-detector states are mainly determined by the status of the HV system. However, the status of the other systems like the cooling or low voltage systems, as well as of the external systems will also be considered to build up the state of the sub-detectors.

The starting situation for a sub-detector is the Off state in which the high voltage system and, in some cases, the low voltage system are switched off although other services like the cooling may be permanently operational. On request from run control, this sub-detector may transit to the Stand-by state after the successful configuration of the front-end equipment. In this state the low voltage system may be turned on and reduced HV values are applied to the sub-detectors. The transition to the Ready state will be performed through various intermediate states, which are mainly determined by the operational characteristics of the HV system of the sub-detector. The number of intermediate states is different depending on the sub-detector and is defined in the configuration database. In the Ready state the sub-detector equipment is ready for data taking. Many of these state changes, though requested by the run control, will actually pass for execution to the DCS (e.g. the run control will ask a detector's HV to be turned on by DCS). The DCS may also turn off or bring the sub-detector hardware into the Stand-by state in a controlled manner after a run. If an error is detected during the transition to any of these states or during data taking, the sub-detector will go to the Error state, where dedicated pre-defined recovery procedures will be applied depending on the type of failure.

The global operation of the DCS will be performed by a single FSM whose states will be built up from the states of the different sub-detectors. Any command issued at this level, which triggers a state transition, will be propagated to the sub-detectors. Similarly, any incident, which affects to the normal operation of a sub-detector, will be reported and it may trigger a transition to the Error state.

### 12.4.3 Operation of the TDAQ states

The three main TDAQ states of Initial, Configured and Running (see Figure 12-5) have been introduced in Section 3.2. These states are now further sub-divided as explained.

Starting from booted but idle machines, the software infrastructure is initialized with the go command to arrive at the Initial state. Two state transitions are traversed between Initial and Running. The loading of the software and configuration data is performed which brings the system to the Loaded state. The system configures the hardware and software involved and enters the Configured state. The TDAQ system is now ready to start data-taking. In the subsequent Running state the TDAQ system is taking data from the detector. Data-taking can be paused and continued causing the LVL1 busy to be set and removed, respectively. The inverse transitions bring the TDAQ system back to the Initial state and it can be ended with the terminate command to arrive to the original state which has no TDAQ software infrastructure.

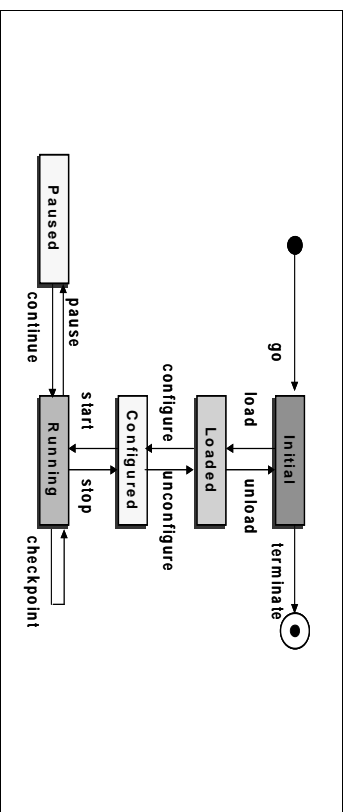

Figure 12-5 TDAQ states

The checkpoint is a transition in a running TDAQ system which is triggered by a change in conditions or by an operator. It results in events following the checkpoint to be tagged with a new run number and does not need the synchronisation, via run control start/stop commands, of all TDAQ elements. Some components in the TDAQ control system require several intermediate states which are used for synchronisation during certain transitions that are internal to the component.

### 12.4.4 Inter-relation of states

As has been discussed above, coherent synchronization between system states is vital in order to ensure the quality of the data and the safe operation of the detector. Communication with the LHC is handled by DCS as described in Chapter 11. DCS transfers both the LHC states and some of its operational parameters to the TDAQ control. On the other hand, parameters measured within the TDAQ system like luminosity, background and beam position, can be used to tune the beams and therefore, must be transferred to the LHC.

Figure 12-6 shows the overall connection for physics data-taking between the TDAQ and DCS states and the LHC conditions. The actions performed by the DCS on the sub-detector hardware are coordinated with the states of the LHC machine. This is the case for example for the ramping up of the high voltages of some sub-detectors, like the Pixel or SCT tracker. These sub-detectors are more vulnerable to high beam background if the high voltage is on, and hence the command to get ready can only be given when the accelerator provides beam with sufficiently low background. The sub-detector states will closely follow the operation of the LHC. However periods of particle injection or acceleration in the LHC may already be used by TDAQ to initialize and configure the different parts of the systems, such as the front-end electronics.

For physics data taking the LHC will be required to signal that stable beam conditions exist. Only when the TDAQ system is in Configured state, and the DCS is ready, the operator may give the command to start physics data-taking. During physics data-taking bi-directional communication continues to take place to assure the correct coordination and to enable the optimization of the beam.

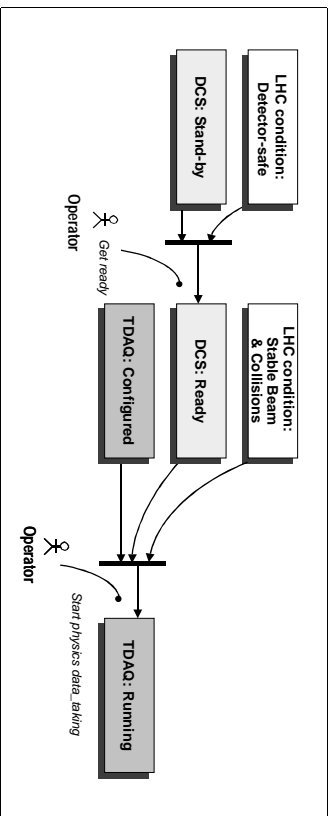

**Figure 12-6.** Basic example connection between the TDAQ states, the detector states and the LHC conditions. Note that the cross-check of LHC conditions is performed by the DCS (not shown here)

The TDAQ control is only partially coupled to the LHC and sub-detector states. State transitions of the TDAQ system are not determined by the state of the LHC. However, changes of the LHC parameters observed in the detector, like the luminosity, may require actions on the DAQ system, like the change of the trigger menus.

The TDAQ system can generally be brought from the initial to the configured state while the LHC is ramping, squeezing and preparing for physics, or while the DCS prepares the detector for data taking. A new run can be triggered at any time regardless of the state of the LHC or of the detector. Data read-out may already start under poor beam conditions using only certain sub-detectors, like the calorimeters, while the high voltage of other detectors will still be set to stand-by. As soon as the safe operation of the remaining sub-detectors is possible, the DCS will prepare them for data taking and will communicate their availability to the TDAQ system. At this moment, the physics data taking may start.

Although some calibration procedures, for example with cosmic rays or with a radioactive source, will be performed without beam, the communication and coordination with the LHC control system is still needed in order to prevent dangerous operations to be engaged which could possibly damage the detector. For most TDAQ internal system tests no co-ordination with the state of the other systems needs to take place.

## 12.5 Control Scenarios

In this section, typical scenarios for the experiment control are presented. The first scenario describes the actions required to drive the system from its initial dormant state to the Running state and back again. The control of the various types of runs such as physics and calibration runs, introduced in Section 3.3, is then discussed. The procedures described rely on the ATLAS partitioning concept which is explained in Section 3.4.

### 12.5.1 Operational Data-taking Phases

The TDAQ states as described in Section 12.4 are traversed when the TDAQ system is run through initialisation, preparation, data-taking and shutdown phases. As the DCS is required to always be operational, in this scenario it is assumed that the DCS is in Stand-by state and ready to connect to the rest of the system. During the operational phases, systems and sub-systems perform a number of operations independent from each other. During the state transitions, actions specific to the sub-system like initializing software and hardware elements, loading software and parameters to hardware modules and configuring them, or starting processing tasks, are performed. Time-consuming operations are preferably performed during early state transitions. The aim is to prepare the TDAQ system to be ready for the start command such that the running state can be entered with a minimum time-overhead.

#### 12.5.1.1 Initialisation

When initiating a data-taking session, the operations of the TDAQ system start from boot but idle CPUs. The operator selects a partition which is described in the configuration database or defines a new one. The process management and information distribution infrastructure, consisting of a number of servers in the distributed system (i.e. process managers, Information Services, Error Message system), is started and initialized. The hardware and software elements of this TDAQ infrastructure are then verified to ensure that they are functioning correctly (for example the servers are tested, the process managers are contacted and therefore the status of their host PCs and the network connection is verified). The sequence and synchronisation of the start-up operations follow the dependencies which are described in the configuration database. The Online Software-DCS communication software is started and the communication between the systems is initialized.

Once this TDAQ infrastructure is in place, the controllers and the application processes, which are part of the configuration, are started. The process management is de-centralized and therefore this can occur asynchronously. The data describing the selected partition is transmitted to DCS. The control communication with DCS is established. Having successfully finished this transition the TDAQ system is in the Initial state.

#### 12.5.1.2 Preparation

Once in the initial state, the operator can begin to configure the system. This involves synchronizing the loading and configuring of all software applications and hardware elements which participate in the data-taking process.

The Loading transition, is used to initialize all the processing elements in the system including, for example, the loading of the configuration data into the various controllers. Subsequently, during the Configuring transition, the various elements of the system are configured according to the information obtained in the previous step, for example, the establishment of communications channels between TDAQ elements such as the L2PUs and the L2SV, or the setting of hardware or software parameters.

The preparation of the sub-detector equipment for data taking involves the issuing of commands to DCS and the subsequent execution of defined control and initialization procedures. These commands can be associated to state transitions of the TDAQ controllers, or be asynchronous commands issued directly by the TDAQ operator or by stand-alone applications. The ac-

tions are detector-specific and are defined in the configuration database. They are loaded into DCS at initialisation time. The different procedures to be performed on the equipment are previously validated and are cross-checked with the states of the external systems and of the common infrastructure to guarantee the integrity of the equipment, e.g. the LHC must have stable beam conditions and acceptable backgrounds before certain sub-detectors' HV may be turned on. In some cases, the execution of these procedures may take several minutes, depending on the actions to be taken. These actions on the detector equipment take place in parallel to the loading and configuring of the TDAQ elements.

The operations described so far may be time-consuming and should, if possible, be performed well before the run start is required, e.g. while waiting for stable run conditions to occur. The readiness of the sub-detectors for data taking is reported to the run control by the DCS which will then be in the Ready state. Generally speaking, the DCS must be in the Ready state for the operator to be able to start a run. However, it is possible to start a run regardless of the state of some or all of the sub-detectors if required (e.g. in commissioning phases when not all the detectors are available). In some cases the TDAQ control may decide to take data without certain sub-detectors or sections of a given sub-detector. In this situation, the associated sub-detector run controllers are excluded from the DAQ partition used for data-taking and consequently, no commands will be issued on the sub-detector DCS, i.e. the sub-detector will remain in the default state (Stand-by) while the other subdetectors participate in the run.

The readiness of the TDAQ system to take data is defined as the moment when the top-level run controller is in the Configured state. This implies that all the data acquisition and trigger systems have been booted, initialized and configured correctly and are ready to receive event data.

### 12.5.1.3 Data-taking

When the run is started by the operator, the LV1 trigger is enabled and event data-taking operations commence. If necessary, a run can be paused and resumed in an orderly manner with minimum time overhead simply by inhibiting or enabling, respectively, the LV1 trigger. In specific circumstances, such as the modification of one of a limited set of pre-defined run parameters (e.g. the beam position), the checkpoint transition, as described in Section 3.3.7, can precipitate a change in run number without having to cycle through the full run-stop and run-start procedures. The advantage of this is to minimize the time required to take account of the possible change in value of one or more of a fixed set of parameters.

Partitions comprising one or more TTC zones can be removed from the main data-taking partition, for example in case of problems with a given detector element. To do this, first the LV1 trigger is inhibited. The detector element in question, together with its associated TDAQ resources (e.g. the ROB associated to its RODs) are then marked as no longer forming part of the main data-taking partition. Finally the LV1 trigger is re-enabled and data-taking can continue. The removed detector element can then be configured for stand-alone operations to allow the faulty element to be identified, tested and repaired. Once the element is functional again, it can be attached again to the main partition.

Depending on the system elements which are involved, the above actions may be able to be completed within a checkpoint transition, or they may necessitate the complete cycling through the run-stop and run-start procedures in order to re-configure the system correctly. Component failures during state transitions or while the system is in a given state which cannot be handled locally are reported through the local controllers to the top level run control. This mechanism is introduced in Chapter 6 and described in Section 10.5.3.

### 12.5.1.4 Stopping

When the operator stops the run, the LV1 trigger is inhibited and data-taking is stopped. The control and application processes involved remain active. No changes on the DCS side are foreseen, the sub-detectors remains in the Ready state and TDAQ in Configured state. Systems and sub-systems may perform different kind of actions during the stopping transition as compared to the pause transition.

### 12.5.1.5 Shut-down

On receipt of the shut-down command all applications and their controllers are stopped. Finally the TDAQ software infrastructure is closed down in an orderly manner, leaving the system available for a new data-taking session. If no further data-taking is foreseen the Ramp Down or Turn Off commands are given to DCS in order to bring the detector to a safe state by ramping down and switching off the low and high voltage applied to the sub-detectors.

## 12.5.2 Control of a Physics Run

For physics data-taking, the hierarchy of TDAQ controllers, including all sub-detectors, is arranged in a single common partition. The information on the type of run is transferred to the DCS system to prepare the different sub-detectors for physics data-taking as described in the previous section. The successful execution of the appropriate DCS procedures to bring the sub-detectors to the Ready state, is then reported to the TDAQ system.

Figure 12-7 shows an example of the experiment control including the TDAQ control and the back-end system of the DCS. The TDAQ root controller holds the highest level of control. It connects to the detector controllers, the farm controllers for EF and L2 and the DF controllers as described in Section 12.3. Each sub-detector controller supervises the controllers of its sections and also the controller which provides the connection to DCS for each sub-detector. The RODs are supervised by their respective sub-detector section controller. In the following, it is assumed that the DCS is in the Ready state and the TDAQ control is in the Running state.

The control of a physics run is driven by the TDAQ system, which acts as the master of the experiment control by issuing commands to the DCS by means of specialized controllers called DDC\_CT. There is one DDC\_CT controller per sub-detector. Those controllers send commands directly to the sub-detector control units on the DCS side. This communication model implies that the TDAQ system interacts directly with the DCS of the various sub-detectors. However, in the case of DDC\_CT connection failures the control of the sub-detectors is taken over by the DCS root control unit (called ATLAS in Figure 12-7) to ensure the safe operation of the detector equipment.

During physics data taking, only a pre-defined set of high-level commands from the TDAQ system to the DCS, like the triggering of the sub-detector state transitions at the start or end of the run, is allowed. The command is logged and feedback on its execution is reported to the TDAQ system. The TDAQ control system handles failures or time-outs from the DDC\_CT in the same way as from other controllers in the system.

Global error handling and recovery is provided by the Online system control described in Section 10.5. Severe problems, e.g. in the HV system of a certain sub-detector, are reported to the TDAQ system. Depending on the problem and on the faulty system element, the TDAQ control

may decide to exclude this sub-detector from data-taking and continue the run with the remaining detectors as described in the previous section. The run may continue if the readout of the detector element in question is not considered vital for the given run.

HLT sub-farms can be removed or added to the global farm control without disturbance of data-taking activity. Breakdown and replacements of individual sub-farm nodes are handled transparently and each of such operations are logged.

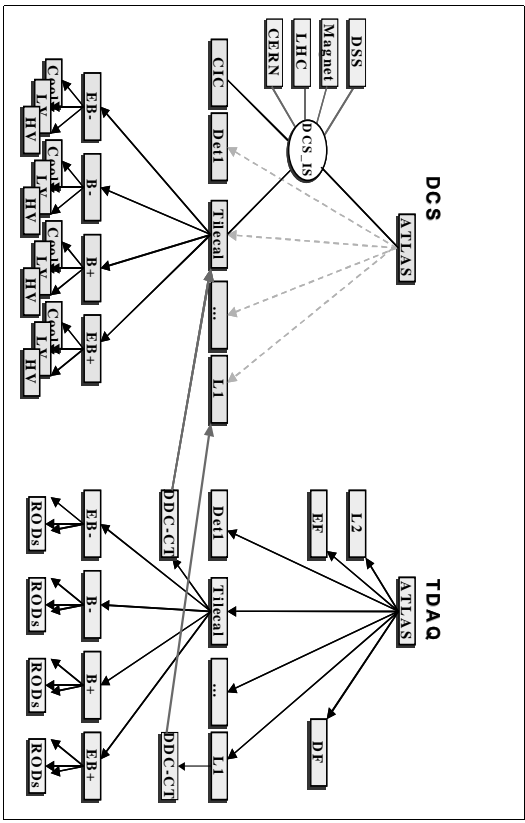

Figure 12-7 Experiment Control indicating the control command flow between TDAQ and DCS, which takes place at each sub-detector level, as illustrated here for the TileCal sub-detector.

### 12.5.3 Calibration Run

The calibration procedures envisaged in ATLAS profit from the flexible partitioning concept allowing for autonomous and parallel operations of the sub-detectors or even of different elements of a given sub-detector. From the point of view of controls, three different types of calibration can be identified:

- Procedures where only the control provided by the Online software system is required, such as the determination of the pedestals for zero suppression.
- Calibration runs entirely handled by the DCS such as the calibration of the cooling system, where the flow of the liquid is adjusted as a function of the temperature of the detector.
- Calibration procedures requiring control from both systems. This is the case, for instance, of the calibration of the Tile Hadron Calorimeter with the radioactive caesium source, where the modules of the detector are scanned with the source under control of the DCS. The signal produced is read by the DAQ system and the information is used to adjust the HV applied to the PMTs of the readout system.

In the latter case, the control needs are similar to the functionality required for physics runs as presented in the previous section. Figure 12-8 shows the example of the interplay between the TDAQ control and the DCS for calibration of the Tilecal detector. As for physics data taking, these calibration procedures are driven by the TDAQ control and commands follow the same path. The main difference with respect to physics data taking, is the arrangement of the partitions. In the example presented in the figure, a TDAQ partition is defined for the stand-alone operation of the Tilecal sub-detector. It is important to note that although some calibration procedures are executed without beam or even without the control provided by the DCS, the communication with the LHC machine and other external systems must always be guaranteed since this information is of crucial importance for the integrity of the sub-detectors and for the preparation of the next run.

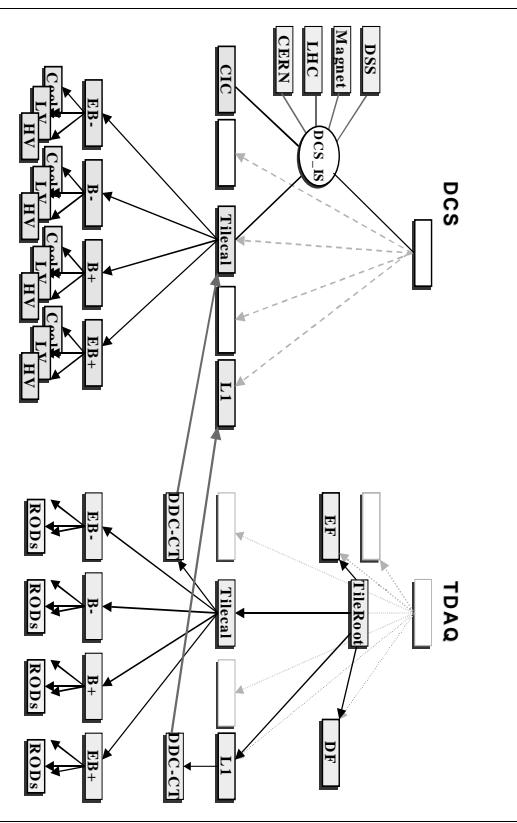

Figure 12-8 Detector Stand-alone control mode, indicating the control command flow between TDAQ and DCS at the sub-detector level, as illustrated here for the TileCal sub-detector.

### 12.5.4 Operation outside a Run

The states of the DCS and TDAQ outside a run are determined by the duration of the periods without data taking. As described in Chapter 3, during transitions between runs and short interruptions, the TDAQ system can be set to one of its intermediate states or be unavailable, while the DCS remains completely operational. If longer interruptions are foreseen, such as periods of machine development, the HV applied to the sub-detectors is reduced and the detector states are set to Stand-by or Off.

During shut-down periods and long term intervals without data-taking, the TDAQ system is not necessarily operational although it may be available on demand for calibration and debugging purposes. In these periods a number of sub-detector services like the LAr cryogenics or ID cooling stay operational. The monitoring and control of the humidity and temperature of the

electronics racks, the supervision of the un-interruptible power supply system and of other detector specific equipment is also performed. The ATLAS magnets are permanently switched on and therefore the interface with the DCS must be continuously available. The radiation levels monitored by the LHC machine must be accessible by the DCS at all times. For these reasons, the DCS is required to be fully operational allowing, if necessary, the sub-detectors to operate without the support of the rest of the TDAQ system. Similarly, the interfaces between the DCS and the fire alarm systems, the access security system and the DSS must be continuously operational.

## 12.6 References

- 12-1 PVSS-II,  
<http://www.pvss.com>
- 12-2 ATLAS High-Level Triggers, DAQ and DCS Technical Proposal, CERN/LHCC/2000-17 (2000)
- 12-3 ATLAS First-Level Trigger Technical Design Report, CERN/LHCC/98-14 (1998)
- 12-4 ICOP Architecture Working Group, Framework Design Proposal, CERN-ICOP-2000-06, 2000,  
<http://cern.ch/itco/Projects-Services/ICOP/SubProjects/Architecture/pdf/HC7.0.pdf>
- 12-5 Partitioning - Global issues working group document,  
<http://cern.ch/atlas-project-ldag-giwig/Documents/Documents.htm>
- 12-6 LHC Operations project,  
<http://lhcop.web.cern.ch/lhcop/>
- 12-7 Runs and States - Global issues working group document,  
<http://cern.ch/atlas-project-ldag-giwig/Documents/Documents.htm>



# Part 3

## System Performance

## 13 Physics selection and HLT performance

### 13.1 Introduction

In the Technical Proposal (TP) for the HLT, DAQ and DCS of the ATLAS experiment, a first understanding of the on-line event selection scheme and the corresponding physics coverage was presented. Since then, the studies have evolved, to cope with different machine scenarios and additional constraints coming from the detector itself. One of the major changes to take into account has been the LHC start-up phase, currently foreseen to deliver 10 fb<sup>-1</sup> in one year, with a peak luminosity per fill of  $2 \times 10^{33}$  cm<sup>-2</sup> s<sup>-1</sup>, a factor of two higher than the Technical Proposal assumptions. This change has motivated a complete revisiting of the approach to the Physics and Event Selection Architecture of the experiment, leading to a novel way of reducing event rates and sizes, while retaining as much as possible of the ATLAS physics goals. Needless to say, only the availability of real data will allow this proposal to find a concrete implementation and the tuning of the relative weights of the selection will only be possible then, when confronted with the environment of LHC data taking.

As it has been explained in Chapter 9, the High Level Trigger (HLT) system of the experiment is composed of two separate data reduction steps, the LVL2 and the Event Filter (EF), each of them with distinctive and complementary features. The common denominator of these selections is that they will operate using software algorithms running on commercial computers to validate the hypotheses of particle identification. The LVL2 will do this with purpose built algorithms that need to operate in about 10 ms and use only part of the detector information at full granularity, the EF will have the fully built event at disposal, with a latency of the order of a second. An important aspect is to maintain a flexible scheme allowing for an easy adaptation to changes in conditions like luminosity or background: the modularity of the HLT will allow the implementation of different reduction steps at different stages.

A mandatory input concerns the seeding of the HLT selection, where a detailed simulation of the first level trigger (LVL1) result is needed: this level identifies the regions of the detector (Regions-of-Interest) where potential candidates for interesting physics objects are found. This detailed simulation, described in Section 13.2, allows for a realistic use of the information coming from LVL1, using the same algorithms and procedures that will be implemented in custom hardware in the experiment.

Given the commonalities and the distinctions of the LVL2 and the EF, it has been recognized that a coherent and organized approach to the software components of the trigger validation was needed to make a fundamental step forward with respect to the TP. The work that will be presented in Section 13.3 has concentrated on this issue, by deriving the common tools for the event selection and identifying the data model components and methods that can be shared across the different algorithms, in particular at LVL2. This will ease the implementation of different selection schemes, by making as well simpler the migration across levels.

Another important focus point for new developments has been the compliance with the updated detector geometry and with the realistic format of the data coming from the ReadOut System. This implies that algorithms will operate on streams of bytes organized according to the readout structure of each detector, in exactly the same way in which they will in the real experiment. This has allowed to study and understand the implication of converting those byte-

streams to the objects needed by algorithms in order to perform trigger selections as well as making preliminary measurements of the overheads stemming from these conversions.

In Section 13.4 the outcome of present studies are presented. Particular emphasis has been put on the selection of electrons and photons, and on the one of muons. For those “vertical slices” of event selections, a thorough implementation of the approach described above has been attempted. After LVL1 validation, data organized according to the readout format are used by LVL2 algorithms, operating within the framework of the PESA Steering and Control (rePESA). Trigger elements are then built using detector information and verified against hypotheses of particle identification. If LVL2 validation is successful, the EF reconstruction and analysis is performed (seeded or not by the LVL2 result) and the final selection published for off-line use. Rejection against dominant backgrounds and efficiencies for typical signals are reported, as well as the rates deriving from each of the selections.

To fully span the ATLAS physics coverage, also signatures involving jets, taus, ETmiss, as well as jets with b-quark content have been studied, and results are reported in the same section. As described in Chapter 4, the available on-line resources will also be used, for luminosities below the peak one, to evaluate b-production cross-section and make precision measurements with B-hadrons.

The global assessment, based on the present evaluation for each signature, of the ATLAS rates to off-line is made in Section 13.5, together with a preliminary description on how to reduce further the data volume by applying compression techniques or zero suppression to the detector information. A sketch of issues related to the initial phase of the experiment seen from the selection architecture point of view is also given in Section 13.6.

### 13.2 The LVL 1 trigger simulation

An important ingredient to many HLT tests and studies is the simulation of the LVL1 trigger the result of which serves as input to the HLT trigger process. The ATLAS LVL1 trigger [13-2] is itself a complex system consisting of the calorimeter trigger, the muon trigger and the Central Trigger Processor (CTP) that makes the final LVL1 event decision. Figure 13-1 gives an overview of the LVL1 trigger; the various components mentioned in the figure will be explained later in this section except for the TTC system (trigger, timing and control) which has no equivalent in the simulation.

The LVL1 trigger simulation is implemented in C++ in the ATLAS offline computing framework Athena and relies heavily on the ATLAS offline data storage implementation, the so-called transient event store (TES). The structure of the simulation follows closely the structure of the LVL1 trigger hardware. Figure shows a package view of the LVL1 simulation. It consists of packages simulating the resistive plate chamber (RPC) muon trigger (indicated by the package TrigTRPC in Figure), the Muon-to-CTP Interface (MuCTPI, package TrigTImuCTPI), the calorimeter trigger (package TrigTICal0) and the Central Trigger Processor (package TrigTICTP). The LVL1 configuration (package TrigTIConfig) and the simulation of the Region-of-Interest Builder (package TrigTIRoIB) are provided as additional packages. There are also packages for the definition of the LVL1 result raw data object (package TrigTIResult), for classes used by more than one package (package TrigTIInterfaces), and for the conversion of the LVL1 result into the hardware format, the so-called bytestream conversion (package TrigTIResult-Bytestream). The various parts of the simulation shown in Figure will be explained in the next sections. The simulation of the muon trigger in the endcaps, the signals for which are provided

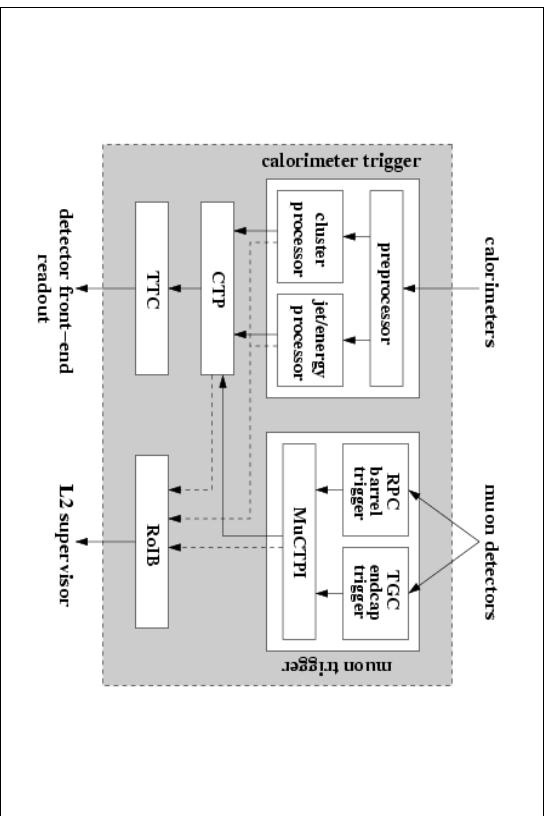

Figure 13-1. An overview of the ATLAS LVL1 trigger system. The Region-of-Interest Builder (RoIB) formally is not a part of the LVL1 trigger; its simulation, however, is done together with the simulation of the other parts of the LVL1 trigger

by the thin-gap chambers (package TriggTTC), so far exists only as a stand-alone program and will not be treated in detail.

The interfaces and data formats to be used in the simulation [13-3] were designed to follow as closely as was practical the data formats used in the LVL1 trigger hardware which are documented in [13-4]. Additional information on the LVL1 simulation can be found in [13-5].

### 13.2.1 Configuration of the LVL1 trigger

The task of the LVL1 trigger configuration is twofold: first, the trigger menu, i.e. the collection of event signatures LVL1 is supposed to trigger on, has to be translated into something that the simulation of the CTP can understand and use in making the event decision based on logical combinations of the inputs delivered by the calorimeter and muon triggers: The LVL1 signatures, or trigger items, are combinations of requirements (or trigger conditions) on the multiplicities of various kinds of candidate objects delivered by the calorimeter and muon triggers found in the event (see later subsections for details about the calorimeter and muon trigger principles and simulations).

A simple example for a trigger item is 'one (or more) electron/photon candidate with transverse momentum above 10 GeV and one (or more) muon candidate with transverse momentum above 13 GeV'. In a frequently used and obvious notation this reduces to: 'EM10+1MU13', where the string 'EM' ('MU') represents the electron/photon (muon) candidate, and the integer numbers in front of and behind the string symbolize the required multiplicity and the required

transverse momentum, respectively. The combination of a candidate string and a threshold value (like 'EM10') is called a trigger threshold.

Second, the calorimeter and muon triggers have to be configured such that they deliver the information required for the event decision by the trigger menu, i.e. that the multiplicities for the required trigger thresholds are sent to the CTP simulation. For the implementation of the above mentioned example the calorimeter trigger has to be configured such that it delivers to the CTP the multiplicity count for the threshold 'EM10', i.e. the number of electron/photon candidate objects with transverse momentum above 10 GeV. It is obvious that the trigger menu and the trigger thresholds for the calorimeter and muon triggers have to be defined consistently. Particularly all thresholds used in the definition of any trigger condition in any trigger item must be delivered by the calorimeter and muon triggers and thus need to be configured.

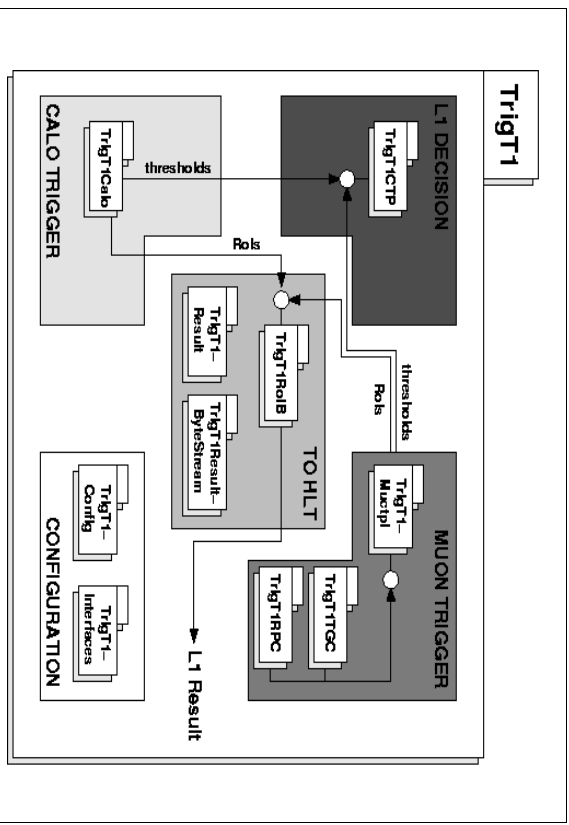

Figure 13-2. A package view of the LVL1 trigger simulation.

Both the trigger menu and the list of required trigger thresholds are defined using XML and are parsed into instances of C++ classes using the Xerces DOM API [13-6]. The parsing of the trigger menu creates an object which contains the information on how the CTP simulation has to discriminate the calorimeter and muon trigger inputs (trigger conditions) and what items have to be built from these conditions.

In addition, in the configuration process configuration objects for the calorimeter and muon triggers are created and are stored in the TES for later retrieval by the calorimeter and muon trigger simulations. These objects contain the list of thresholds for which the subsystems have to provide multiplicity information to the CTP simulation.

The LVL1 trigger configuration software is currently being adapted to also be able to configure the LVL1 trigger hardware by deriving the necessary look-up table files and FPGA configura-

tion files from the XML trigger menu and trigger threshold list. Such a common configuration scheme will allow for cross-checks between hardware and software.

### 13.2.2 The calorimeter trigger and its simulation

The LVL1 calorimeter trigger [13-7] has to provide information on localised energy depositions in the ATLAS calorimeters, which might be due to single particles (electrons, photons, hadrons), to tau leptons or to hadronic jets with transverse energies ( $E_T$ ) above a set of pre-defined thresholds and satisfying certain isolation criteria. The multiplicities of these candidate objects are counted and are passed on to the CTP to be used in the LVL1 event decision. In addition, the calorimeter trigger calculates global energy sums (total and missing transverse energy) which are discriminated against a set of configurable thresholds and are also used in the CTP event decision.

The ATLAS calorimeter starts with the signals of 7200 trigger towers which are analogue sums of trigger cells in the liquid argon and tile calorimeters. The trigger tower signals are digitized in the preprocessor electronics and then subject to two different trigger algorithms: Electron/ photon and tau/hadron candidates are searched for within the 6400 trigger towers of granularity  $\eta \times \phi = 0.1 \times 0.1$  in the central part of the ATLAS calorimeters ( $|\eta| < 2.5$ ) using the Cluster Processor. For the algorithms searching for jet candidates and deriving global energy sums in the Jet/Energy Processor, coarser (jet) elements of granularity  $0.2 \times 0.2$  are used, which are built from all 7200 trigger towers and are available for a larger rapidity range ( $|\eta| < 3.2$  in case of the jet trigger).

In case of the electron/photon trigger a candidate object is defined by a local maximum of transverse electromagnetic calorimeter energy in a region of  $2 \times 2$  trigger towers corresponding to a  $0.2 \times 0.2$  region in  $\eta$ - $\phi$  space. In addition, vetos on the amount of hadronic energy in that region and on the amount of energy surrounding the  $2 \times 2$  region are applied. The highest transverse energy sum that can be built from any neighbouring two of the four trigger towers in the  $2 \times 2$  region defines the transverse energy of the candidate object which is discriminated against the predefined thresholds. See [13-2] and [13-8] for a more detailed description of the various calorimeter trigger algorithms.

In addition to the counting of object multiplicities, Regions-of-Interest (RoIs) are defined using the highest  $E_T$  thresholds passed by the candidate objects and a bit pattern indicating their location. These RoIs are transmitted to the Region-of-Interest Builder and serve to seed the HLT event decision process. All relevant calorimeter trigger information is also provided to the readout using S-LINKS.

The LVL1 calorimeter trigger simulation is designed to reproduce the functionality of the hardware, but does not entirely duplicate the dataflow. The primary reason is efficiency — the hardware trigger will process large amounts of data in parallel, which does not translate well to offline simulation software.

Currently the simulation starts from input calorimeter cell signals; there exists no dedicated simulation of trigger tower signals. The cell signals can be taken from the fast ATLAS simulation or from the detailed GEANT calorimeter simulation. It is also possible to feed the software with hardware test vectors, i.e. test patterns for which the output of the trigger logic is known and which thus serve for functional tests of the hardware and software.

The cell signals are then used to build, in a simplified geometrical approach, trigger tower signals to which calibration and a gaussian noise can be applied. The tower data are passed to the

Cluster Processor simulation (electron/photon/tau/hadron finding), and are summed into the coarser Jet Elements to be used in the simulation of the Jet and Energy Processors (jet finding and building of energy sums). The multiplicity outputs for the CTP simulation are produced and stored in the TES for later retrieval, and the simulated candidate objects are formatted according to the S-LINK data protocol and are stored for later use in the RoIs simulations. So far there is no simulation provided for the readout data stream.

The HLT steering software requires the RoIs to be given not in terms of the LVL1 internal data format (basically a bit pattern detailing the electronics module the signal came from and a bit indicating the threshold that was passed), but using the coordinates in  $\eta$ - $\phi$  space and the value (in GeV) of the threshold that was passed. In order to provide this information, software converters are provided to translate the raw 32-bit RoI data words into objects, complete with methods to return the required data.

SAV SOMETHING ABOUT CALORIMETER TRIGGER VALIDATION HERE!!!!

### 13.2.3 The RPC muon trigger and its simulation

In the barrel part of the ATLAS detector ( $|\eta| < 1.05$ ) the muon trigger uses information from the resistive plate chamber detectors (RPC) of which ATLAS has six layers organised in three so-called stations [13-9]. The middle RPC station (RPC2) is called the pivot plane. The algorithm that finds muon candidates works as follows [13-10]: each hit found in the pivot plane is extrapolated to the innermost RPC station (RPC1) along a straight line through the interaction point, and a coincidence window is defined around the point where the line hits the station RPC1. Since the ATLAS magnetic field will bend the trajectory of charged particles, the size of the coincidence window defines the transverse momentum  $P_T$  of muon tracks that can be triggered. A low- $P_T$  muon candidate is found if there is at least one hit in the coincidence window and if in at least one of the stations RPC1 and RPC2 there are hits in both planes. If, in addition, there is a coinciding hit in at least one of the two planes of the outermost station RPC3, a high- $P_T$  candidate has been found. For each of the 64 sectors of the RPC trigger, up to two muon candidates can be selected and sent to the MuCTPI.

The input to the simulation of the muon trigger logic is provided by a package that performs the simulation of the RPC trigger detector system; this is done with the program ATLSIM. The muon detector layout used for this simulation is the version "P03" [13-11]: the geometry of the single RPC stations and the position of these stations in the muon spectrometer is reproduced in great detail, following with care the engineering drawings. The material composition and geometry of the single RPC units are also correctly simulated. The simulation of the RPC detector response is based on the results obtained in test-beam experiments. The hits produced by the simulation of charged particles crossing the RPC detectors are collected and stored in output files and can be used in downstream packages for the simulation of the trigger logic and also for the event reconstruction.

The detector simulation stage is followed by a set of Athena algorithms which are used to simulate in detail the logic of the LVL1 muon barrel trigger. There are basically two sets of objects:

The first set is a collection of objects corresponding to (and simulating the behaviour of) the basic elements of the hardware system: the Coincidence Matrix ASIC (CMA), the Pad board, the Sector Logic and the ReadOut Driver. All data belonging to a given CMA are recorded in a dynamic structure, and the input register bits corresponding to the fired channels are set to one. Channel masking, time alignment and the introduction of an artificial dead time to the fired channels are possible although not used yet in the present implementation. The trigger data of

the eight CMAs belonging to a given Pad board are processed following the same logic as the electronics, and the output of all Pads belonging to a given trigger sector are sent to the corresponding Sector Logic. The Sector Logic identifies the two highest transverse momentum muon candidates among all the Pads and provides the addresses of the relevant Regions-of-Interest. The output of the Sector Logic is finally stored in the TES from where it can be retrieved by the MuCTPI simulation.

The second set of objects comprises four packages which reproduce the architecture of the muon trigger system and have access to the geometry of the RPC trigger system. The main functions of these packages are the mapping between different hardware components (RPC detectors to CMAs to Pads to Sector Logic objects), the configuration of the CMAs according to the thresholds chosen, and the data transfer between the different parts of the simulation.

The CMAs supply information also to the readout system; this data path is also simulated. The resulting data are organised in a structure that follows exactly the one adopted in the hardware (bytestream format). This, together with software converters for the interpretation of the bytestream data, allows the use of the RPC data in LVL2 selection algorithms like muFast [13-12].

In addition to the simulation just described, a fast simulation of the trigger logic for a fast emulation of the LVL1 trigger logic at LVL2 is provided.

The simulation software was completely rewritten with respect to the software used for the HLT technical proposal [13-13] and has only recently been integrated into the overall LVL1 trigger simulation. Therefore, the validation process has just started; so far no results showing the equivalence of the current simulation with the one used in the technical proposal or demonstrating the improved performance of the trigger due to a more precise simulation and a better detector description are available. Some information on the performance of the RPC muon trigger can be found in [13-12] and [13-14].

### 13.2.4 The Muon-to-CTP interface and its simulation

The Muon-to-CTP Interface (MuCTPI, [13-15]) receives up to two muon candidates from each of the 208 sectors of the barrel (RPC) and endcap (TGC) muon triggers. From these candidates, the multiplicities of muons are calculated for six different muon  $P_T$  thresholds and are sent to the CTP. In case the event is accepted, up to 16 candidates (chosen are the ones with the highest  $p_T$ ) are formatted to conform to the ATLAS ROD standard and are sent via the Region-of-Interest Builder to the HLT and, via a separate link, to the readout system. The MuCTPI suppresses candidates which are the result of double-counting due to overlapping muon chambers.

The MuCTPI simulation follows the hardware scheme as closely as possible, down to the data formats used in the hardware. The dataflow is emulated using the same stages of processing as in the hardware, including the propagation of error and status bits. Access functions are provided for every type of information available in the hardware. The simulation was originally a stand-alone program for extensive tests of the prototype MuCTPI hardware. It has recently been ported to the ATLAS offline Framework, Athena. It has been integrated with the simulation of the RPC muon chambers and trigger on the input side, and with the simulations of the CTP and the RoIB on the output side. Also the output to the readout is simulated; this is however not yet used within the LVL1 simulation efforts.

### 13.2.5 The LVL1 CTP and its simulation

The LVL1 trigger event decision is made in the Central Trigger Processor (CTP, [13-16]) in the afore mentioned two-step procedure:

The threshold multiplicities from the calorimeter and muon triggers are discriminated against the trigger conditions introduced in Section 13.2.1 — simple multiplicity requirements. Depending on the inputs from the calorimeter and muon trigger, each trigger condition takes a logical value TRUE or FALSE.

The trigger conditions (or rather their logical values) are combined using AND, OR and NOT operations to give complex trigger items. Each trigger item corresponds to a signature to be triggered by LVL1 as defined in the trigger menu; gates and prescales can be applied to each individual item. The LVL1 trigger result is then the logical OR of all trigger items. The final CTP design will probably foresee up to 96 trigger items.

The logical relations between the conditions and the items on one side, and the conditions and the input threshold multiplicities on the other side, are provided by the LVL1 trigger configuration (Section 13.2.1). The CTP provides identical output to the RoIB and to the readout; the information that is sent comprises bit patterns for the input signals and for the trigger items before and after prescales and vetos, and the L1A signal.

In the currently existing prototype hardware implementation of the CTP, the CTP-D ('D' for demonstrator, [13-17]), this selection procedure is implemented using two look-up tables (LUT) for the multiplicity discrimination and two programmable devices (CPLD) for the combination of conditions to items. The final design of the CTP will probably incorporate only one big programmable device in which both above mentioned steps can be performed.

The existing CTP simulation follows closely the CTP-D design — conversion to the final CTP design may eventually require some effort, depending on how close to the hardware implementation the simulation software is supposed to be.

First, the input threshold multiplicities provided by the calorimeter trigger and MuCTPI simulations are collected, and the multiplicities that are required in the trigger menu are discriminated against the respective conditions which are taken from the C++ object representing the trigger menu that is provided by the configuration step.

In a recursive algorithm the conditions are then combined to trigger items. Taking into account the logical relations is facilitated by the use of XML as the medium for the trigger menu definition.

Then all items are passed through a prescale algorithm, and the logical OR of all items is formed, resulting in the LVL1 event result (the LVL1 accept or L1A signal which might be 0 or 1, FALSE or TRUE). No effort has been undertaken so far to implement the deadline algorithms realized in the hardware.

Finally, the CTP result object, which in content and format corresponds precisely to the one provided by the hardware, is formed and stored in the TES for later use by the RoIB.

### 13.2.6 Interface to the HLT

The interface between the LVL1 trigger and the HLT is the Region-of-Interest Builder (RoIB, [13-18]) which formally is not a part of the LVL1 trigger. This device collects the information relevant for the HLT from the calorimeter and muon triggers and from the CTP, and combines all data into a single block which serves as input to the LVL2 supervisor. The data are transmitted in S-LINK format (four S-LINKS from the calorimeter trigger cluster processor, two from the jet/energy processor, and one from each the MuCTP and CTP). The RoIB has to operate at the highest foreseen LVL1 output rates without introducing additional deadline.

The RoIB simulation picks up the S-LINK information stored in the TES by the calorimeter trigger MuCTP and CTP simulations and constructs a LVL1 result raw data object (RDO). This object, the content of which is used to seed the HLT steering, can then be converted into persistent or transient hardware (or bytestream) format using a software converter which is provided within the LVL1 simulation effort, as is the converter for translating the bytestream format back into objects which serve to seed the HLT trigger and contain the value (in GeV) of the passed threshold and the location of the RoI in the  $\eta$ - $\phi$  space.

## 13.3 Common tools for selection

The HLT algorithms are the basic software components which provide data to derive the trigger decision. These algorithms operate within the context and environment of the PESA Core Software which is discussed from a conceptual design and architectural standpoint in [Chapter 9](#). Section 13.3.1 provides an overview and description from the viewpoint of these HLT algorithms. The objects of a common Event Data Model which algorithms exchange and manipulate are described in Section 13.3.2. An inventory of HLT algorithms intended to operate in the LVL2 environment is given in Section 13.3.3 while those for the EF are described in Section 13.3.4.

### 13.3.1 Algorithmic View of the Core Software Framework

Unlike their counterparts in the Offline Software environment, HLT algorithms must allow themselves to be guided by the PESA Steering, to be seeded by Trigger Elements, and to operate with a restricted set of event data.

To accomplish the Steering guidance of algorithms using Sequence Tables and Trigger Elements, a Seeded approach is required. Trigger Elements characterizing abstract physics objects have a label (e.g., 'electrons' or 'jets') and effectively decouple the Steering and Physics Selection from details of the Event Data Model used by the algorithms. Via the Navigation scheme within the PESA Core Software environment, algorithms may obtain concrete event data associated with a given Trigger Element which define the Seed of restricted and relevant event data fragments upon which they should work.

The Trigger processing itself starts from a LVL1 RoI using predefined Sequences of algorithms. These LVL1 RoI objects are associated to Trigger Elements allowing them to be acted upon by the Steering. For each of these Trigger Elements, the Steering executes the required algorithms as defined in a Sequence Table. Hence, it is possible that a given algorithm may be executed  $N$  times per event. This is fundamentally different than the 'Event Loop' approach of the Offline reconstruction paradigm where a given Offline algorithm would act only once upon each event.

At LVL2, event data reside within ROBs until actively requested. This allows the LVL2 algorithms to request and process only a small fraction of event data from ROBs, representing a substantial reduction in the network and computation resources required. The first step in this process is the conversion of a geometrical region (e.g., a cone with an extent  $\eta$  and  $\phi$ ) into Identifiers: this is accomplished with the HLT RegionSelector.

The HLT RegionSelector [13-20] translates geometrical regions within the fiducial volume of the detector into a set of Identifiers. Presently these Identifiers are `IdentifierHashes` used in the offline software environment. They correspond to elements of appropriate granularity in each sub-detector, usually a `DetectorElement`. As such, the RegionSelector uses `DetectorDescription` information during its initialization phase to build an `EtaPhiMap` for each layer (or disk) of a subdetector. This map is essentially a two-dimensional matrix in  $\eta$  and  $\phi$ . Each element consists of a `List of IdentifierHash`, the column indices are  $\phi$  floating point numbers while a range  $(\eta_{\min}, \eta_{\max})$  specifies row indices. The input to RegionSelector is the sub-detector under consideration (i.e., Pixel, SCT, TRT, LAr, Tile, MDI, RPC, CSC, or TGC) and the physical extent of the geometrical region. Given the vastly different designs of each subdetector, a subdetector-dependent procedure is used. With knowledge of the layers and/or disks in the region, the RegionSelector searches the  $\phi \rightarrow \text{IdentifierHash}$  map which will give a set of `IdentifierHash` is relevant in  $\phi$  region. The last step is to validate each `IdentifierHash` inside the `IdentifierHash  $\rightarrow$  ( $\eta_{\min}, \eta_{\max}$ )` map.

Interactions with the Data Collection system are hidden from the Algorithm behind a call to `StoreGate`. Within `StoreGate`, event data are aggregated into collections within an `IdentifierContainer` (IDC) and labelled with an Identifier. Algorithms request event data from `StoreGate` using the set of Identifiers obtained by the HLT RegionSelector. If the collections are already within `StoreGate`, it returns them to the HLT algorithm. If not, `StoreGate` uses the `IOpaqueAddress` to determine which ROBs hold the relevant event data and requests it from the Data Collection system. A `ByteStream` converter converts the Raw Data into either Raw Data Objects (RDOs) or, by invoking a `DataPreparation Algorithm`, into Reconstruction Input Objects (RIOs). The obtained RDOs or RIOs are stored within the collections within the IDC within `StoreGate`.

### 13.3.2 Event Data Model Components

During 2002 and 2003, there has been a substantial ongoing effort within the HLT, Offline, and subdetector communities to establish a common Event Data Model (EDM) between HLT and Offline software in the areas of the raw and reconstruction data models. In the discussion that follows, the concept of a `DetectorElement` is used as an organizing and identifying principle for most EDM objects; these are discussed in Section 13.3.2.1. At the time of writing this document, there has been convergence with respect to the raw data model described in Section 13.3.2.2. Common reconstruction data model classes specific to LVL2 and EF algorithms have been developed and are described in Section 13.3.2.3 and Section 13.3.2.4.

#### 13.3.2.1 Event Data Organization

Event Data (e.g., Raw Data Objects (RDOs) and Reconstruction Input Objects (RIOs)) are aggregated into collections corresponding to adjacent readout channels within the physical detector. These collections reside in an `IdentifierContainer` (IDC) with Identifier labels corresponding to the unit of aggregation. For most sub-detectors, the organizing principle is that of the `DetectorElement`.

In the Pixel detector a DetectorElement is a module, equivalent to a single Silicon wafer: hence there are 1744 Pixel DetectorElements. For the SCT, a DetectorElement is one side of a module, equivalent to a bonded pair of wafers whose strips are oriented in a single direction (i.e., axial or stereo); there are 8176 SCT DetectorElements. For the TRT, a DetectorElement is a planar set of straw tubes representing one row at a constant distance from the module inner wall of straws in a barrel module (i.e., a plane corresponding to the tangential direction in the barrel) and  $1/32$  in  $\phi$  at a given  $z$  of straws in an end-cap wheel; there are 19008 TRT DetectorElements [13-19].

For the calorimeters, the concept of DetectorElement is difficult to define. Instead, the organizing principle for event data is that of the Trigger Tower.

Within the muon spectrometer, for the MDTs, a DetectorElement is a single MDT chamber; where there is at most a single MDT chamber per station, and typically, an MDT chamber has two multilayers. An RPC DetectorElement is the RPC components associated to exactly one barrel muon station; there may be 0, 1 or 2 RPC doublet sets per station and a doublet set may comprise 1, 2 or 4 RPC doublets. A TGC DetectorElement is one TGC  $\eta$  division, or chamber, in a TGC station; there are 24 forward stations in a ring and 48 endcap stations in a ring and there are four rings at each end of the ATLAS detector. Finally, for a CSC DetectorElement is a single CSC chamber, where there is at most a single CSC chamber per station. A CSC chamber typically has two multilayers.

### 13.3.2.2 Raw Data Model Components

ByteStream Raw Data is ROB-formatted data produced by the ATLAS detector or its simulation [13-19]. It is defined by a set of hierarchical fragments, where only the bottom level, the ROD fragment, is defined by the sub-detector group. The format of the ByteStream has not yet been formally defined. Hence, preliminary "best guesses" have been made as to its structure which may undergo changes in the future.

A Raw Data Object (RDO) is uncalibrated Raw Data converted into an object representing a set of readout channels. Historically this has been referred to as a Digit. It is the representation of Raw Data which is put into the Transient Event Store (TES) and is potentially persistible.

The purpose of the RDO converters is dual: first a Raw Data ByteStream file can be created by taking the information from the already filled RDOs (in the transient store, from ZEBRA); second, this ByteStream file can then be read back by the converters to fill the RDOs (or the RDOs for LVL2). Since the RDOs are a representation of the specific detector output, its content can change with the life time of the sub-detectors.

A detailed description of the Raw Data Model components is available elsewhere [13-21].

### 13.3.2.3 Reconstruction Data Model Components

Algorithms interact with Reconstruction Input Objects (RIOs) as opposed to RDOs. For each subdetector system, classes of RIOs have been defined and are described in the following subsections.

#### 13.3.2.3.1 Inner Detector

The implementation of the RIOs makes use of the `IdentifiableContainer` base class, and the collections are also according to the granularity of DetectorElements.

The Pixel and SCT RIOs are Clusters. A Cluster in the Pixel detector is a two-dimensional group of neighbouring readout channels in a DetectorElement. A Cluster in the SCT is a one-dimensional group of neighbouring readout channels in a DetectorElement. For Pixel and SCT, there are currently two implementations of the Cluster class: one used for EF and Offline and one used for LVL2. The one used at EF has Pixel and SCT sharing the same class. For LVL2 there is a common structure for Pixel, SCT and TRT, but they all have their own concrete classes. For Pixel and SCT there is a base class used for LVL2. There is also an Extended class which could potentially be used at EF (which inherits from the LVL2 base class) in the future. Both LVL2 and EF set of cluster classes contain a list of RDO identifiers from which the cluster is built. The number of member functions is limited in both set of classes and the member functions follow the Inner Detector Requirements [13-19]. It is assumed that in the future there will be only one set of RIO classes to be used for LVL2, EF, and Offline.

At LVL2, Pixel and SCT RIOs are converted to 3-dimensional coordinates in the ATLAS global coordinate system using the `AlgTools SCT_SpacePointTool` and `PixelSpacePointTool`. These tools accept as input a STL vector of pointers to Cluster Collections of the appropriate type, `SCT_ClusterCollection` or `PixelClusterCollection`, and return a STL vector of objects of the class `TrigsSpacePoint`. A UML class diagram of the LVL2-specific `SpacePoint` class `TrigsSpacePoint` and associated `IndetRecoInput` classes is shown in Figure [Ref: fig:spacepoint]

For the Pixels, the creation of SpacePoints consists of combining the local coordinates of Clusters with information on the position and orientation of the DetectorElement to give the global coordinates. The process for the SCT is more complicated since a single SCT detector provides only a one-dimensional measurement. However, an SCT module, consisting of two detectors in a stereo-pair, provide 2-dimensional information. One species of SCT DetectorElement, phi-layer, has strips orientated parallel to the beam axis, the other, u or v layer, is rotated by  $\pm 40\text{mrad}$  with respect to the phi-layer DetectorElements. The formation of SpacePoints consists of the following steps:

- Associate each phi-layer Cluster Collection<sup>1</sup> with the corresponding stereo-layer Cluster Collection;
- For each pair of Collections (phi + stereo), take each phi-layer Cluster and search for associated stereo-layer Clusters. If there is more than one associated stereo layer Cluster, a SpacePoint is formed for each (in this case one, at most, will be a correct measurement, the others will form 'ghost' points). If no associated stereo-layer hit is found, a point is created from the phi-layer information alone;
- Calculate the second coordinate (z for the barrel, or R for the end-caps);
- Using information on the position and orientation of the DetectorElement transform to global coordinates.

Note that for the LVL2 SpacePoints some simplifications are made in the interest of speed, as follows:

1. There is a Cluster Collection per DetectorElement.

- No attempt is made to form SpacePoints from Tracks passing close to the edge of a module, where the corresponding stereo-layer Cluster is in a different module.
- Since the stereo and phi layers are separated by a small distance, the trajectory of the track will influence the measurement of the second coordinate. Since the trajectory is not known at the time that SpacePoints are created, there will be a corresponding increase in the uncertainty in the measurement in the second coordinate ( $R$  or  $Z$ ).

The TRT RIO is the drift circle of a straw. In the case of the TRT, the same classes are used for LVL2, EF, and Offline: those classes are the `DriftCircle` classes part of the set of classes that are also used at LVL2 for Pixel and SCT. The granularity of the TRT RIO is the same as for the RDO: that of a straw, thus the RIO contains an identifier which is the offline identifier for a straw. In the case of the RDO the straw information is uncalibrated and is just the direct content of the detector output, while in the case of the RIO the straw information is calibrated: out of the drift time, a drift radius is obtained. For now, the drift function applied is the same for all straws. In the future the constants that go into the parametrization of this drift function will come from the Interval of Validity Service [13-23].

### 13.3.2.2 Calorimeters

For the Calorimeters, the RIOs are calibrated calorimeter cells (`LArCells` and `TileCells`), imported from the offline reconstruction.

Both `LArCells` and `TileCells` have `CaloCell` as a common base class which represents the basic nature of an observation in the calorimeters an energy, position, time, and quality. A `CaloCell` has been calibrated so that `energy()` returns the physical energy deposit in the cell with units of GeV, but without any kind of leakage corrections. Time is given in nanoseconds and refers to when the deposit occurred, relative to the trigger; it should be zero for good hits. Quality reflects how well the input to the system matched the signal model on which the algorithm is based. It is a number with a value between zero to one, giving the significance of the hypothesis that the actual signal is a sampling of the signal model (i.e., it is the integral of a probability distribution from negative infinity to an observed value of a test statistic and ought to be uniformly distributed between zero and one if the hypothesis is correct).

### 13.3.2.3 Muon Spectrometer

[Need text here.]

## 13.3.2.4 Reconstruction Output

### 13.3.2.4.1 Tracks

A track is, in general, an object containing a parametrization of a hypothesized particle trajectory through space relating groups of RIOs and/or SpacePoints together. A Track trajectory consists of three position, two direction, and one curvature<sup>1</sup> parameters. If a track is evaluated at an intersecting surface, there are five parameters and a covariance matrix.

A proposed uniform Track class exists for LVL2 algorithms, the `TrigIndeTrack` class. A UML class diagram of `TrigIndeTrack` and associated classes is shown in Figure [Ref: fig:track]. No such uniform Track class yet exists in the Offline environment.<sup>1</sup>

### 13.3.2.4.2 Calorimeter Clusters

[To be written]

## 13.3.3 HLT Algorithms for LVL2

### 13.3.3.1 IDSCAN

IDSCAN (see Refs. [13-32] and [13-33]) is a track reconstruction package for LVL2. It takes as input SpacePoints found in the Pixel and SCT Detectors. A series of sub-algorithms (`ZFinder`, `HtFilter`, `GroupCleaner`, `TrackFilter`) then processes these and outputs Tracks and the SpacePoints associated with them.

The `ZFinder` finds the z-position of the primary interaction vertex. The algorithm puts all hits into narrow  $\phi$ -bins and extrapolates pairs of hits in each bin back to the beam-line, storing the z of intersection in a histogram. It takes as the z-position the histogram region with the most entries.

The `HtFilter` finds groups of hits compatible with Tracks from the z position found by `ZFinder`. It puts all hits into a histogram binned in  $\phi$  and  $\eta$ . It then finds clusters of hits within this histogram. It creates a group of hits if such a cluster has hits in more than a given number of layers.

The group of hits found by `HtFilter` is used by `GroupCleaner` which splits groups into Tracks and removes noise hits from groups. Each triplet of hits forms a potential track for which  $P_r$ ,  $\phi_0$ , and  $d_0$  are calculated. It forms groups from these triplets with similar parameters, applying certain quality cuts. It accepts a track candidate if a group contains enough hits.

Finally, the `TrackFilter` verifies track candidates and finds the track parameters by using a standard Kalman-filter-type fitting algorithm adapted from SCKalman [13-24]. It returns a list of SpacePoints on the Track, the Track parameters, and an error matrix.

### 13.3.3.2 SITrack

SITrack is a track reconstruction package for LVL2 which extends and upgrades a previous algorithm called `PxTrig`. SITrack takes Pixel and SCT SpacePoints as input and outputs fitted reconstructed Tracks, each storing pointers to the SpacePoints used to build it. SITrack is

<sup>1</sup> The use of curvature assumes a homogeneous magnetic field in which case this quantity is constant. For ATLAS and its significantly inhomogeneous magnetic field in the end-cap region of the Inner Detector and in the Muon Spectrometer, this parameter may be replaced by an invariant quantity such as  $charge/p$ .

1. There are of course Track classes defined internally within ORPs such as `IPatRec` and `xKalman++`.



implemented as a single main algorithm `STTrack` which instances and executes a user defined list of sub-algorithms (chosen among `STSpacePointSorting`, `STMuonVertex`, `STTrackSeeding`, and `STThreePointFit`).

`STSpacePointSorting` collects pointers to `SpacePoints` coming from the Pixel and SCT detectors and sorts them by module address, storing the result in a Standard Template Library (STL) map. This processing step is performed in order to speed-up data access for the other reconstruction sub-algorithms.

`STMuonVertex` is a primary vertex identification algorithm mostly suitable for low luminosity events with an high  $p_T$  muon signature. It is based on track reconstruction inside the LVL1 muon RoI: the most impulsive track is assumed to be the muon candidate and its  $z$  impact parameter is taken as the primary vertex position along  $z$ .

`STTrackSeeding`, using the sorted `SpacePoint` map and a Monte Carlo Look-Up Table (MC-LUT) linking each B-layer module to the ones belonging to other logical layers, builds track seeds formed by two `SpacePoints` and fits them with a straight line; one or more logical layers can be linked to the B-layer, the latter option being particularly useful if robustness to detector inefficiencies must be improved. If the primary vertex has already been reconstructed by `STMuonVertex`, a fraction of fake track seeds can be rejected during their formation, applying a cut on their  $z$  distance from the primary vertex. Otherwise, if no vertex information is available, an histogram whose resolution depends on the number of seeds found is filled with the  $z$  impact parameter of each seed; its maximum is then taken as  $z$  position for the primary vertex. This vertexing algorithm, which can be operated in both RoI and full scan modes, is best suitable for high luminosity events containing many high  $p_T$  tracks (e.g. b-tagging). Independent cuts on  $r$ - $\phi$  and  $z$  impact parameters are eventually applied to the reconstructed seeds to further reduce the fake fraction.

`STThreePointFit` extends track seeds with a third `SpacePoint`; it uses a Monte Carlo map associating to each seed a set of module roads<sup>1</sup> the track could have hit passing through the Pixel or SCT detectors. A subset of modules is extracted from each road according to a user defined parameter relating to their 'depth' inside it (e.g. the user can decide to use modules at the beginning or in the middle of each road, etc.). `SpacePoints` from the selected modules are then used to extend the seed and candidate tracks are fitted with a circle; ambiguities (e.g. tracks sharing at least one `SpacePoint`) can be solved on the basis of the track quality, leading to an independent set of tracks that can be used for trigger selection or as a seed for further extrapolation.

### 13.3.3.3 TRTLUT

`TRT-LUT` is a LVL2 tracking algorithm for track reconstruction in the TRT. It is described in detail elsewhere [13-25]. The algorithm takes as input Hits in the TRT. The algorithmic processing consists of Initial Track Finding, Local Maximum Finding, Track Splitting, and Track Fitting and Final Selection. It outputs the Hits used and Tracks with their parameters.

During the Initial Track Finding, every hit in a three-dimensional image of the TRT detector is allowed to beyond to a number of possible predefined tracks characterized by different parameters. All such tracks are stores in a Look-Up Table (LUT). Every hit increases the probability that a track is a genuine candidate by one unit.

1. A road is a list of modules ordered according to the radius at which they are placed starting from the innermost one.

The next step consists of Local Maximum Finding. A two-dimensional histogram is filled with bins in  $\phi$  and  $1/p_T$ . A histogram for a single track would consist of a "bow-tie" shaped region of bins with entries at a peak in the center of the region. The bin at the peak of the histogram will, in an ideal case, contain all the hits from the Track. The roads corresponding to other filled bins share straws with the peak bin, and thus contain sub-sets of the hits from the track. A histogram for a more complex event would consist of a superposition of entries from individual tracks. Hence, bins containing a complete set of points from each track can be identified as local maxima in the histogram.

The Track Splitting stage of the algorithm analyzes the pattern of hits associated to a track candidate. By rejecting fake candidates composed of hits from several low- $p_T$  tracks, the track splitting step results in an overall reduction by a factor of roughly 2 in the number of track candidates. For roads containing a good track candidate, it identifies and rejects any additional hits from one or more other tracks. The result of the overall Track Splitting step is a candidate that consists of a sub-set of the straws within a road.

The final step of `TRT-LUT`, Track Fitting and Final Selection, performs a fit in the  $r$ - $\phi$  ( $z$ - $\phi$ ) plane for the barrel (end-caps) using a third order polynomial to improve the measurement of  $\phi$  and  $p_T$ . Only the straw position is used (i.e. the drift time information is not used). The track is assumed to come from the nominal origin. After the fit, a reconstructed  $p_T$  threshold of 0.5 GeV/c is applied.

### 13.3.3.4 TRTKalman

`TRT-Kalman` [13-26] is a new package based on `xKalman++` (see Section [13.3.4.1]). The name is in fact a misnomer since the Kalman filter component of `xKalman++` is not used for the TRT: a histogram search and Least Squares fit is used instead.

`TRT-Kalman` incorporates following modified modules from `xKalman`:

- `XK_Tracker_TRT`: This reads TRT geometry from ROOT files. It uses `INDEPDESCR_IDENTIFIER` to access necessary Detector Description information;
- `XK_Algorithm`: A strategy is added to perform TRT standalone reconstruction;
- `XK_Track`: A step has been added with fine-tuning of track parameters after the histogramming step and Least Squares fit;
- `XKATTMan`, `XKATRTRec`: This contains `xKalman++` internal steering algorithms;
- `XKATRTClusters`: This component retrieves `TRT_RDO_Container` from `StoreGate` filled from a `ByteStream` file.

### 13.3.3.5 TZCalo

`TZCalo` (see Refs. [13-27], [13-28], [13-29], [13-30]) is a clustering algorithm for electromagnetic (EM) showers, seeded by the LVL1 EM trigger RoI positions [13-31]. This algorithm can select isolated EM objects from jets using the cluster  $E_T$  and certain shower-shape quantities.

The RIOs are calibrated calorimeter cells (`LARCells` and `TileCells`), imported from the offline reconstruction. Both `LARCells` and `TileCells` have `CaloCell` as common base class. The output (`TZEMCluster`) is a specific LVL2 class containing the cluster energy and position, and the shower-shape variables useful for the selection of EM showers.

The first step in T2Calo is to refine the LVL1 position from the cell with highest energy in the second sampling of the EM calorimeter. This position  $(\eta_1, \phi_1)$  is later refined in the second sampling by calculating the energy weighted position  $(\eta_c, \phi_c)$  in a window of  $3 \times 7$  cells (in  $\eta \times \phi$ ) centered in  $(\eta_1, \phi_1)$ . As described in Ref. [13-28], the steps to perform the jet rejection are the following:

- In sampling 2,  $R_{\text{shape}} = E_{3 \times 7} / E_{7 \times 7}$  is calculated. The expression  $E_{n \times m}$  stands for the energy deposited in a window of  $n \times m$  around  $(\eta_1, \phi_1)$ .
- In sampling 1,  $R_{\text{strip}} = (E_{1st} - E_{2nd}) / (E_{1st} + E_{2nd})$  is obtained in a window of  $\Delta \eta \times \Delta \phi = 0.125 \times 0.2$  around  $(\eta_c, \phi_c)$ .  $E_{1st}$  and  $E_{2nd}$  are the energies of the two highest local maxima found, obtained in a strip-by-strip basis. The two  $\phi$ -bins are summed and only the scan in  $\eta$  is considered. A local maximum is defined as a single strip with energy greater than its two adjacent strips.
- The total transverse energy  $E_T$  deposited in the EM calorimeter is calculated in a window of  $3 \times 7$  cells around  $(\eta_1, \phi_1)$ .
- Finally, the energy that leaks into the hadron calorimeter  $E_{had}_T$  is calculated in a window of size  $\Delta \eta \times \Delta \phi = 0.2 \times 0.2$  around  $(\eta_c, \phi_c)$ .

### 13.3.3.6 muFast

The muFast algorithm is a standalone LVL2 tracking algorithm for the Muon Spectrometer. In the past, it existed in the Reference software from ATTRIG, and this version is described in detail elsewhere [13-34].

The program is steered by the Rol given by the LVL1 Muon Trigger and uses both RPCs and MDTs measurements. At present this algorithm is limited to the barrel region and it is based on four sequential steps:

1. LVL1 emulation: the muon pattern recognition in the MDT system is initiated by the RPC hits that induced the LVL1 trigger accept. Among these hits, only those related to the pivotal plane (middle RPC station) are provided by the muon trigger processor; the ones related to the coincidence plane (innermost and outermost RPC stations) have to be identified running a fast algorithm that simulates the basic logic of the LVL1 selection.
2. Pattern recognition: it is performed using the RPC hits that induced the LVL1 trigger to define a road in the MDT chambers around the muon trajectory. MDT tubes lying within the road are selected and a contiguity algorithm is applied to remove background hits not associated with the muon trajectory.
3. A straight-line track fit is made to the selected tubes (one per each tube monolayer) within each MDT station. For this procedure the drift-time measurements is used to fully exploit the high measurement accuracy of the muon tracking system. The track sagitta is then evaluated.
4. A fast  $p_T$  estimate is made using LUTs. The LUT encodes the linear relationship between the measured sagitta and the  $Q/p_T$  as a function of eta and phi.

The output of this algorithm is the measurement of the muon transverse momentum  $p_T$  at the main vertex, eta and phi.

### 13.3.3.7 muComb

The combination of the features of the track measured in the Muon Spectrometer and the Inner Detector (ID) at LVL2 provides a rejection of  $\pi$  and K decays to  $\mu$  and of fake muons induced by the cavern background. Moreover the combination of the two measurements improves the momentum resolution of reconstructed muons over a large momentum range.

The matching of the Muon Spectrometer tracks and of the ID can be performed extrapolating the ID track to the muon system. The procedure needs to take into account the detector geometry, the material composition and the inhomogeneity of the magnetic field. An accurate extrapolation would require the use of detailed geometry and magnetic field databases, together with a fine tracking. All this would be expensive in terms of CPU time and therefore not acceptable for the LVL2 trigger.

To provide a fast tracking procedure, the effects of the geometry, the materials and of the magnetic field have been described by simple analytic functions of eta and phi. The extrapolation of the ID tracks to the entrance of the Muon Spectrometer is performed using linear extrapolation in two independent projections: the transverse and the longitudinal views. Two coordinates are extrapolated: the z-coordinate and the azimuthal angle phi. The linear extrapolation is corrected using average corrections. In the transverse projection the ID track extrapolation in phi is corrected as follows:

$$\Delta\phi = \frac{\alpha}{p_T - p_T^0} \quad 13-1$$

where  $\alpha$  is related to the field integral and  $p_T^0$  allows for the transverse energy loss in the material of the calorimeter, that is approximately independent of the track transverse momentum  $p_T$ . Both alpha and  $p_T^0$  have been determined by fitting  $\Delta\phi$  of simulated muons as a function of  $p_T$ . It is found that  $p_T^0 \sim 1.5$ , i.e. about half of the transverse energy loss of low energy muons, as naively expected. A similar approach has been followed in the case of the extrapolation of the z-coordinate in the longitudinal view.

The matching is done geometrically using cuts on the residuals in each of z and phi.

For matching tracks the combined transverse muon momentum is estimated through a weighted average of the independent  $p_T$  measurements in the Muon Spectrometer and in the Inner Detector. For each combined track, a  $\chi^2$  parameter is used to evaluate the quality of the  $p_T$  matching. Thanks to the high quality of the muon  $p_T$  measurements in both detectors, secondary muons from  $\pi$  and K decays give typically bad  $\chi^2$  matching, and thus can be rejected.

## 13.3.4 HLT Algorithms for EF

### 13.3.4.1 xKalmann++

xKalmann++ is a package for global pattern recognition and Track fitting in the Inner Detector for charged tracks with transverse momentum above  $0.5 \text{ GeV}/c$ . A more detailed description of this algorithm is available elsewhere [13-35].

The algorithm starts the track reconstruction in the TRT using a histogramming method or in the Pixel and SCT detector layers using segment search.

The first reconstruction method outputs a set of possible track candidate trajectories defined as an initial helix with a set of parameters and a covariance matrix. As a second step the helix is then used to define a track road through the precision layers, where all the measured clusters are collected. `KKalman++` attempts to find all possible helix trajectories within the initial road and with a number of sufficient clusters.

The primary track finding in the Pixels or SCT outputs a set of `SpacePoints` as an initial trajectory estimation. In the next step these set of space points serve as an input for the Kalman filter-smoother formalism that will add the information from the precision layers. Each reconstructed track is then extrapolated back into the TRT, where a narrow road can be defined around the extrapolation result. All TRT Clusters together with the drift time hits found within this road are then included for the final track-finding and track-fitting steps.

There are three seeding mechanisms available in the offline environment: `XKASeedSALL`, the reconstruction of the full event; `XKASeekLINE` reconstruction of a region-of-interest and soon available EM calorimeter seeding. In the HLT environment as an EF algorithm `KKalman++` will be seeded by the LVL2 result.

After the pattern recognition and Track fitting steps `KKalman++` stores the final Track candidates as `SimpleTrack` objects in a `SimpleTrackCollection`. The Track candidate contains the following information:

- Fit procedure used (m-fit or e-fit);
- Helix parameters and their covariance matrix at the end-points of the filter procedure in the precision layers (point on the trajectory closest to the vertex) and in the TRT (point on the trajectory closest to calorimeter);
- Total  $\chi^2$  resulting from final fit procedure;
- List of all hits on track from all sub detectors;
- Total number of precision hits  $N_p$ ;
- Total number of straw hits  $N_s$ , empty straws crossed  $N_e$ , and of drift-time hits  $N_t$ ;
- Furthermore, a track candidate is stored in the final output bank if it passes the following cuts:
  - The number of precision hits is larger than 5 to 7;
  - The ratio  $N_s/(N_s+N_e)$  is larger than 0.7 to 0.8;
  - The ratio  $N_t/N_s$  is larger than 0.5 to 0.7;
  - No previously accepted track has the same set of hits as the current one; this last cut removes full ghost tracks.

### 13.3.4.2 iPatRec

A detailed description of iPatRec is available elsewhere [13.3.6].

[Need text here.]

### 13.3.4.3 LAClusterRec

LAClusterRec is the reconstruction package for electromagnetic clusters in the calorimeter.

In the first step towers are created by summing the cells of the electromagnetic calorimeter and the pre-sampler in depth using a granularity of  $\Delta\eta \times \Delta\phi = 0.025 \times 0.025$  corresponding to the granularity in the second sampling of the EM calorimeter. The input of the tower building are the calibrated calorimeter cells which are produced by the package LARCellRec.

In the next step a sliding window algorithm is used. In case a local maximum is found with a total energy in the window above a given transverse energy threshold, clusters are created which are subsequently stored in the cluster container. To reconstruct the cluster energy and position is calculated in a given window.<sup>1</sup> The cluster energy is corrected for  $\eta$  and  $\phi$  modulations and leakage outside the cluster in a given window. In the region between the barrel and end-cap calorimeter the cluster energy is in addition corrected for energy losses using the energy deposit in the crack scintillators. The  $\eta$  position in the first and second sampling is corrected for s-shapes, which is a geometrical effect. The  $\phi$  position is corrected for an offset, which is also a geometry effect.

### 13.3.4.4 egammaRec

EgammaRec is designed to calculate useful quantities to separate clusters in the electromagnetic calorimeter from jets. To do so, electromagnetic cluster information as well as tracking information is used.

In the electromagnetic calorimeter electrons are narrow objects, while jets tend to have a broader profile. Hence, shower shapes can be used to reject jets. This is handled by the `EMShowerBuilder` which calls different algorithms which calculate diverse quantities using the information in the first and second sampling of the electromagnetic calorimeter as well as the leakage into the first sampling of the hadronic calorimeter.

Cluster and track information is combined in the `TrackMatcherBuilder`. For a given cluster all tracks are examined in the given window around the cluster position. In case more than one track is found, the one with the highest  $P_t$  is retained. If the  $E/p$  ratio is  $0.5 < E/p < 1.5$ , the track match is successful. In the subsequent particle identification step the information provided by `egammaRec` can be used. In the case of an electron hypothesis, jets can be rejected by analysis of the EM shower shapes, tight track quality cuts,  $E/p$ , and the position match in  $\eta$  and  $\phi$  between the cluster and the tracks. Photons can be selected by analysing the EM shower shapes, reconstruction of conversions in the Inner Detector, and possibly a track veto for non-converted photons.

1. This window can be different from the one used for the sliding window algorithm.

### 13.3.4.5 Moore

Moore (Muon Object Oriented Reconstruction) is a track reconstruction package for the Muon Spectrometer. A detailed description of Moore is available elsewhere [13-37].

Moore takes as input collections of digits or clusters inside the Muon Spectrometer (CSC, MDT, RPC, TGC) and outputs fitted reconstructed tracks whose parameters are expressed at the entrance of the muon spectrometer.

The reconstruction is performed in several steps and each step is driven by an Algorithm module, `Moore::XXX`. Each algorithm is independent (i.e., it retrieves objects created by the previous modules from `StoreGate` and it builds a transient object to be recorded in `StoreGate` where it is available for the subsequent algorithms). The only link between algorithms are the transient objects, in such a way that the algorithms depend on transient objects but transient objects do not depend on algorithms. The decoupling between data and algorithms and the natural step sequence of algorithm performing the reconstruction gives the opportunity to plug-in different reconstruction algorithms at run time.

As it is now, the overall reconstruction starts from the searches for  $\phi$  regions of activity and builds `PhiSegments` (`Moore::PhiSegment`s). For each  $\phi$ -Segment, the associated MDTs are found and a crude `RZSegment` is built (this is essentially a collection of  $z$  hits) (`Moore::RZSegment`s).

Inside the MDTs the drift distance is calculated from the drift time, by applying various corrections, such as the TOF, the second coordinate, the propagation along the wire, the Lorenz effect. From the 4 tangential lines the best one is found. All the MDT segments of the outer station are combined with those of the Middle layer. The MDT hits of each combination are added to the phi-hits of the  $\phi$  Segment, forming outer track candidates. All the successfully fitted candidates are kept for further processing (`Moore::Road`s).

The successful outer track is subsequently used to associate inner station MDT hits. A final track is defined as a successfully fitted collection of trigger hits and MDT hits from at least two layers (`Moore::Tracks`). The parameters of the fitted track are referred to the first measured point and are therefore expressed at the entrance of the Muon Spectrometer.

When dealing with data already selected by the trigger the first two steps (`Moore::PhiSegments`) and (`Moore::RZSegments`) can be substitute with ad hoc makers that seed the track search in the regions selected by the trigger.

## 13.4 Signatures, rates and efficiencies

In the following subsections, the physics performance of algorithms for LVL2 and EF is summarized for five final-state classes: electrons and photons; muons; jets; taus and missing EF- $b$ -jets; and B-physics. This broad classification stems from the physics goals of the ATLAS experiment, as explained in Chapter 4. Whenever possible, results will include the realistic use of data formats and associated converters (as described in previous section), steering control (as described in Chapter 9), highlighting the flexible boundary between LVL2 and EF. Selection schemes are then derived, which contain the signatures used to decide whether or not to reject events. In order to maximize the discovery potential, the selection schemes generally only use inclusive signatures. Except for the case of B physics, reconstruction of exclusive decays is not required and no topological variables (e.g. the calculation of invariant masses from a combination of several

high- $p_T$  objects) are used in the selection, although this is technically feasible at LVL2 or in particular in the EF (e.g. to select  $Z \rightarrow l^+l^-$  decays exclusively).

It is worthwhile noticing that system performance (e.g. execution time, amount of data needed) is one of the major requirement in the HLT selection, to comply with the constraints imposed by the on-line environment and resources. In this chapter an indication of the compliance with those requirements will be given for the most important selections, whilst a detailed analysis of the different contributions to those figures will be given in Chapter 15. In general, all results have been achieved by optimizing concurrently physics and system performances.

### 13.4.1 $e/\gamma$ muon

In the present view of the ATLAS trigger menus, the inclusive electron and photon triggers are expected to contribute an important fraction of the total high- $p_T$  trigger rate. After the selection in LVL2 and the EF, the remaining rate will contain a significant contribution from signal events from Standard Model physics processes containing real isolated electrons or photons ( $W \rightarrow e\nu$ ,  $Z \rightarrow ee$ , direct photon production, etc.).

The electron and photon triggers can be viewed as a series of selection steps of increasing complexity. After receiving the LVL1 electromagnetic ( $e.m.$ ) trigger RoI positions, the LVL2 trigger performs a selection of isolated  $e.m.$  clusters using the full calorimeter granularity and detailed calibration (see Section [13.3.3.5]). This selection is based on cluster  $E_T$  and shower-shape quantities that distinguish isolated  $e.m.$  objects from jets. A further, more refined calorimeter-based selection may classify the  $e.m.$  cluster as a LVL2 photon trigger object.

Electrons are identified at LVL2 by associating the  $e.m.$  cluster with a track in the Inner Detector. This association can be as simple as requiring the presence of a track with a minimum  $p_T$  in the  $e.m.$  RoI, but may, in addition, require position and momentum matching between the track and the cluster. Typically, track candidates are found by independent searches in the TRT and SCT/Pixel (Precision) detectors in the region identified by the LVL1 RoI. Details of the different LVL2 tracking algorithms used for the studies presented here are described in Sections [13.3.3.1], [13.3.3.2], [13.3.3.4].

As currently planned by the HLT scheme, the EF will select events using as far as possible the algorithms of the ATLAS offline reconstruction system, which implies these algorithms have to comply with the stricter EF requirements in terms of robustness and system performance. Currently this is not yet achieved, however, work is in progress to change the algorithms accordingly. The present study uses the currently available ATLAS offline reconstruction software as discussed in Section [13.3.4] as a prototype of the future EF code. The criteria to identify electrons and photons need to be softer at the EF level in order not to loose events prematurely. In previous studies [13-42] and [13-44], the offline electron and photon selection has been applied using the same identification criteria as the offline selection just leaving out few "critical" criteria. For example a track veto for non-converted photons has not been applied on the EF level because it requires a good control of the fake tracks in the inner detector and thus, a very good understanding of the tracking performance especially in the presence of pile-up. A more realistic EF electron selection has been used for the studies presented here. The EF algorithm components (calorimetry, tracking and particle identification) are treated in a similar way as for LVL2. The main differences with respect to LVL2 derive from the availability at the EF of more detailed calibrations and more sophisticated algorithms with access to the full-event data. The improved performance results in sharper thresholds and better background rejection. In the case

of electrons, bremsstrahlung recovery will be performed for the first time at the EF. In addition, a photon-conversion recovery procedure will be applied to photon candidates at the EF.

In the following the system and physics performance of the selection of electrons by the HLT will be reviewed in detail. The photon selection is not discussed here. These studies are currently in progress and no results are available yet. The physics performance of the electron and photon selection has been already studied in detail in the past by the HLT and are reported in [13-41]–[13-44]. The system performance part of this selection is discussed in [Chapter 14](#).

### 13.4.1.1 HLT Electron Selection Performance

The performance of the electron and photon triggers has been estimated for single electrons and photons, and for some standard physics channels (e.g.  $Z \rightarrow ee$ ,  $W \rightarrow e\nu$ ,  $H \rightarrow 4e$ ). The performance has been characterized in terms of efficiency for the signal channel, rate expected for the selection and algorithm execution time. The rates shown in this and in the following sections have been obtained using a sample of simulated dijet events with pile-up added for the low and design luminosity scenario (see Ref. [13-45]). Compared to previous studies a more up to date detector geometry has been used and pile-up effects for the low luminosity scenario of  $2 \times 10^{33} \text{ cm}^{-2} \text{ s}^{-1}$  has been as well taken into account. In general, events with electrons and photons are selected on the basis of single high- $p_T$  objects or of pairs of lower- $p_T$  objects. The physics performance of the electron triggers is summarized here and documented in detail for the three trigger levels in Ref. [13-46] and Ref. [13-47]. An overview can be found in table [13-1].

**Table 13-1** Performance of the isolated electron HLT trigger at design and low luminosity for the single electron selection. The results are presented in a single sequence, except for the starting point of the LV12 tracking, where two alternatives (TRT and Precision) are shown. ‘Matching’ refers to position and energy-momentum matching between calorimeter clusters and reconstructed tracks (at LV12 both Precision and TRT tracks are used). The efficiencies are given for single electrons of  $p_T = 30$  (25) GeV a design (low) luminosity over the full rapidity range  $|\eta| < 2.5$ . The efficiencies and rates are given with respect to a LV11 output efficiency of 9% (9%) and a LV11 rate for e.m. clusters of xxx kHz (xxx kHz). The timing results quoted here are for events from the dijet sample and are scaled to correspond to a 4 GHz machine running Linux. The terms  $m_{90}$  and  $m_{95}$  are defined in [13.4.1.2]. The quoted errors are statistical.

Trigger Step	Design Luminosity			Low Luminosity		
	Rate [Hz]	Efficiency [%]	Timing $m_{90}/m_{95}$	Rate [Hz]	Efficiency [%]	Timing $m_{90}/m_{95}$
LV12 Calo	$3490 \pm 160$	$97.1 \pm 0.3$	$0.20 / 0.26 \text{ ms}$	$1100 \pm 30$	$96.4 \pm 0.6$	$0.15 / 0.23 \text{ ms}$
LV12 Precision	$620 \pm 70$	$90.3 \pm 0.6$	$6.2 / 12.7 \text{ ms}$	$150 \pm 11$	$92.4 \pm 0.8$	$2.4 / 5.8 \text{ ms}$
LV12 TRT	$1360 \pm 100$	$89.7 \pm 0.6$	$0.4 / 1.2 \text{ s}$	$360 \pm 17$	$89.2 \pm 0.9$	$31 / 210 \text{ ms}$
LV12 Matching	$460 \pm 60$	$85.3 \pm 0.7$	--	$140 \pm 11$	$88.1 \pm 0.9$	--
EF Calo	$313 \pm 50$	$83.5 \pm 0.8$	$0.39 / 0.63 \text{ s}$	$85 \pm 8$	$86.4 \pm 1.0$	$0.34 / 0.56 \text{ s}$
EF ID	$149 \pm 34$	$79.3 \pm 0.8$	$11 / 71 \text{ s}$	$57 \pm 7$	$82.4 \pm 1.1$	$0.31 / 1.6 \text{ s}$
EF Matching	$117 \pm 30$	$77.6 \pm 0.8$	--	$41 \pm 6$	$80.8 \pm 1.2$	--

The performance of the single isolated electron HLT algorithm is summarized in table [13-1] as a function of the main steps in the LV12-EF trigger chain. The trigger steps have been factorized by detector in order to show the overall computational load and rejection that each stage con-

tributes to the trigger. The table shows that the input rate from the LV12 electron trigger to the EF is xxx Hz (xxx Hz) at design (low) luminosity for a nominal  $p_T$  threshold of 30 GeV (25 GeV). The overall reduction in rate achieved by LV12 is a factor of xx (xx) for a loss of efficiency of xx% (xx%) with respect to LV11. The additional rate reduction provided by the EF amounts to a factor of xxx (xxx) for a relative efficiency loss of xxx% (xxx%). Using the offline electron selection the rate is reduced by xxx (xxx)%, for an additional loss of xx (xx)% in efficiency. This shows that the HLT selection is very powerful. The LV12 selection has an efficiency of 9x% (9x%) for the events selected by the EF alone, and the additional loss of events is mostly due to the fast track selection at LV12, showing the expected correlation of inefficiencies at the LV12 and EF stages (e.g. due to bremsstrahlung). Compared to previous results (see Ref. [13-44]) the rates quoted here are higher. This is partly due to the looser selection on the EF level, but mainly due to the increase of material in the inner detector, resulting in more electrons which undergo bremsstrahlung effects. Especially due to the new insertable layout of the pixel b-layer more material is found near the beampipe. Hard bremsstrahlungs effects occurring in this material cannot be identified in the tracking system and thus is unrecoverable. Due to these effects the rate has gone up by approximately a factor of 2 (1st guess, to be confirmed).

At low luminosity, the events remaining after the HLT electron selection consist of  $W \rightarrow e\nu$  decays ( $xx \pm x\%$ ), isolated electrons from  $(b, c) \rightarrow eX$  decays ( $xx \pm x\%$ ) and background from high- $p_T$  photon conversions and misidentified hadrons ( $xx \pm x\%$ ). At design luminosity, where a higher  $p_T$  threshold is applied, the corresponding proportions are ( $xx \pm x\%$ ), ( $xx \pm x\%$ ) and ( $xx \pm x\%$ ). The quoted errors are the statistical uncertainties on the estimates. As seen around 30% (update later) of the selected events at the trigger level contain ‘real’ electrons, hence a further improvement of this selection can only be small.

Electron decays of the  $W$  are selected by the EF with an efficiency of ( $xx \pm x\%$ ) at low luminosity and ( $xx \pm x\%$ ) at design luminosity, in agreement with the values given in table [13-1] for single electrons of 25 GeV and 30 GeV transverse momentum respectively. Finally, as an example of the performance for a physics signal, the HLT selection efficiency (using both the single- and the double-electron trigger) for the decay  $H(130) \rightarrow 4e$  is ( $9x \pm x\%$ ) at low and ( $9x \pm x\%$ ) at design luminosity. For  $Z \rightarrow ee$  events the efficiency is ( $9x \pm x\%$ ) ( $9x \pm x\%$ ) at low (design) luminosity. These high efficiencies are due to the large electron multiplicity in the final state.

### 13.4.1.2 HLT Electron/Photon Algorithm Optimization

The algorithm execution time has been measured in order to study the resource constraints they may place on the overall HLT/DAQ system. This exploratory study addresses the interplay between the physics and the system performance aspects. Timing measurements were carried out on the feature-extraction part of the algorithms, excluding as much as possible any I/O (data read/write), and thus characterizing the most computationally complex aspects of the algorithms. In order to assess the impact of tails on the timing results, the measurements are given in terms of the median ( $m_{50}$ ) and the latency within which 95% of the events are processed ( $m_{95}$ )<sup>1</sup>.

To understand where the computing resources are being used in the trigger, the different parts of the LV12 and EF algorithms have been profiled in the test-bed studies, which are summarized in [Chapter 15](#) and as well given in table [13-1]. The time consuming components in the se-

1. The timing measurements were carried out on several different platforms, but have been converted to the same overall scale, corresponding to a 4 GHz Pentium PC equivalent.

lection chain have been identified and work has started to improve the system performance of this part. It should be noted that the current offline algorithms were not aimed at running on the EF at the time they were developed. Significant progress to run on the EF level and speeding-up of the programs is expected in the near future. There are still quite some possibilities to speed up the execution time and the numbers given in section xxx will improve with time. To give an example one possibility to speed up the code is to optimize different algorithm parameters. Here the aim is to eliminate any resource-consuming tasks that contribute only marginally to the rejection. Similar studies have been performed for the EF. As an example, Figure xxx shows the execution-time dependence of the EF electron-tracking algorithm on the transverse-energy threshold of the calorimeter cluster used to seed the reconstruction. (The seed energy scale does not correspond to the calibrated electron energy scale.) Increasing the threshold, thus reducing the number of seeds, reduces the execution time (in particular  $m_{\mu\mu}$ ) with a negligible impact on the physics performance.

The present system performance of the electron/photon algorithms can be improved at all levels of the HLT. There are studies under way which will be documented in future TDAQ notes.

### 13.4.1.3 HLT Strategy and the LVL2-EF Boundary

The use of system resources in the electron HLT can be minimized by exploiting the modularity of the trigger. By ordering the trigger steps in such a way that events are rejected as early as possible, both overall processing times and data transfers are reduced. Factorizing the trigger algorithm components also provides flexibility to move the rejection power from LVL2 to the EF or vice versa, to optimize the following: the performance of the implementation of the algorithm; the robustness of the selection with respect to the rate; the load implied at each level; etc. These issues have been studied in the past and are reported in Ref. [13-41]. As an example, Figure xxx shows that an increase in efficiency can be obtained, with a modest increase in the total HLT output rate, by moving the whole LVL2 tracking selection to the EF. However, in this case, the input rate to the EF would increase by a factor of about eight, with important consequences on the computing load on the EF.

An important aspect of optimizing the sharing of rejection between LVL2 and the EF is the determination of the rejection contributed by each trigger level at the same efficiency. After tuning the LVL2 and EF electron selections to yield the same efficiency for events selected by LVL1, the EF contribution to the total reduction in rate is still better than LVL2 by a factor of two (three) at design (low) luminosity.

In case the incoming trigger rate is too high and needs to be reduced two obvious ways to do so is either to raise the energy threshold of the trigger menu item or by stricter selection criteria. All of these will imply an additional loss in efficiency for physics signals. Part of this loss in physics can then be recovered by more selective triggers. The preferred and easiest way to reduce the rate is to raise the energy thresholds. The LVL1 rate is dominated by the contribution from single high- $p_T$  e.m. objects. As an example, raising the thresholds by  $E_T=5$  GeV of the single electron trigger would yield in a final HLT rate of xxx (xxx) at low (design) luminosity. This is also seen in Figure xxx, which illustrates the impact of raising the threshold for the single-electron HLT selection only (nominal threshold of 30 GeV), while keeping the double-electron trigger threshold at its nominal value (20 GeV for each electron). The upper plot indicates the reduction in rate for the sum of the single- and the double-electron trigger contributions. As the threshold is increased, besides the reduction of fake electrons, also the contribution from real  $W \rightarrow e\nu$  decays is gradually rejected. Figure yyy illustrates the impact on this physics signal, as well as for  $Z \rightarrow e^+e^-$  decays: for thresholds below 35 GeV, the efficiency for Z's is only slightly re-

duced. Decays with more than two electrons are affected even less, e.g. in the case of  $H(130) \rightarrow 4e$ .

As illustrated above, the proposed strategy contains considerable flexibility. Various possibilities exist to reduce the required computing resources or to improve the physics performance. For many channels of interest, the selection scheme also provides considerable redundancy. More details on the trigger selection strategy is given in Chapter 4.

### 13.4.2 Muon selection

The main purpose of the high-level muon trigger is the accurate reconstruction of muon tracks in the RoIs indicated by the LVL1 muon trigger. LVL2 and EF must reject low- $p_T$  muons, secondary muons produced in the in flight decays of charged pions and kaons and fake muons originating from the cavern background. The EF must be able to reconstruct additional muons present in the event not reconstructed or selected by the LVL2 trigger.

Whilst the LVL1 trigger system uses only hits from the dedicated trigger detectors (RPCs in the barrel and TGCs in the endcap), the LVL2 and EF has access to the full measurements of the Muon Spectrometer, including in particular the data from the Monitored Drift Tubes (MDTs). This allows the best muon track reconstruction. The high background environment in the Muon Spectrometer demands algorithms with robust and fast pattern recognition capable of rejecting hits induced by the cavern background.

The tracks found in the LVL2 Muon Trigger are extrapolated for combination with the Inner Detector and the Calorimeter. Matching between muon tracks measured independently in the Muon System and the Inner Detector selects prompt muons and reject fake and secondary muons. This is important in particular for the B-physics trigger in low-luminosity running, for which the selection of prompt low- $p_T$  muons events defines the input of the B-physics trigger algorithm.

The studies presented in this section are limited to the barrel region ( $|\eta| < 1$ ).

#### 13.4.2.1 The Physics Performances of LVL2 Muon algorithms

The  $p_T$  resolution of reconstructed muons is crucial to the selection efficiency and to the rejection of low  $p_T$  tracks that can be achieved at LVL2. The distribution of  $(1/p_{T\text{muon}}^2 - 1/p_{T\text{muon}}^2)/(1/p_{T\text{muon}}^2)$  obtained by the muFast algorithm is shown in figure [figure TP 8-5] for  $p_T=6$  GeV/c. The non Gaussian tails arise largely from the presence of soft particles produced by the muon interacting with the material of the detector.

The  $p_T$  resolution of the muFast algorithm is shown as a function of  $p_T$  in figure [figure TP 8-7]. As shown in the figure, the resolution ranges between 4.0% and 5.5% for muon in the  $p_T$  interval 6-20 GeV/c. These results are well compared with the transverse momentum resolution obtained by the offline muon reconstruction program MUONBOX.

The selection efficiency of muFast for selecting prompt single muons at 6 GeV/c and 20 GeV/c thresholds, relative to muons accepted by the LVL1 muon trigger, are shown in figure [figure TP 8-9]. For a nominal threshold of 6 GeV/c, the efficiency is about 90%, including detector acceptance. This efficiency is 95% for the 20 GeV threshold.

The total rates after this algorithm, including the rejection provided by the LVL1 selection, have been evaluated by convolving the algorithm efficiency as a function of  $p_T$  with the muon differential cross section production of the dominant physics processes. Where the available statistics are too low (in particular for the high- $p_T$  rate calculation) to evaluate the efficiency, the lowest  $p_T$  at which an efficiency estimate has been possible ( $p_T=10$  GeV/c) is assumed conservatively to constitute a plateau extending down to the lower limit of the  $p_T$  acceptance ( $p_T=3$  GeV/c in the barrel). The rates from  $\pi/K$  decays are calculated using the predicted cross-sections from the DMPIET program, and would be lower by about 50% if the PYTHIA prediction were used.

The total rates after LVL2 are shown in Table 13-2.

[THE ABOVE NUMBERS NEEDS TO BE CHECKED].

Preliminary studies of the trigger rate arising from the cavern background as predicted by the FLUKA package have been done. The probability that a fake LVL1 muon trigger is accepted by the LVL2 is below  $10^{-2}$ . This upper limit is sufficient to neglect the contribution from fake muons.

Preliminary studies have been made to evaluate the physics performances of the muComb algorithm. Figure [figure TP 8-10] shows the combined reconstruction efficiency of prompt and secondary muons, as a function of the muon  $p_T$ , where the standalone codes from muFast and the LVL2 Precision algorithm [reference to the related chapter] have been used. The requirement of a good muon track matching ( $Z/p_h$  and  $p_T$  matching) reduces the low  $p_T$  trigger rate to 1.0 KHz; a factor three reduction compared to the rate from the muFast algorithm. Including the further reduction in rate due to the increase in  $p_T$  resolution for prompt muons, the total rate from the muComb algorithm is 2.1 KHz from muons with  $p_T > 6$  GeV/c.

### 13.4.2.2 The Physics Performances of the Muon Event Filter in preparation

### 13.4.2.3 The Timing Performances of the Muon Algorithms

The muFast trigger algorithm has been benchmarked on several processors. On a processor corresponding to 10 SPECint95, muFast takes  $\sim 2$ ms/RoI, fairly independent from the trigger threshold and the muon  $p_T$ -analyzed. If the data access is taken into account the time increases to XX ms.

A realistic evaluation of the time needed to the LVL2 muon trigger to take a decision has to take into account the time needed to move the data from the RoBs to the LVL2 processor in the ATLAS TDAQ architecture. Testbed measurements have been performed and indicates that the global time taken from the LVL2 trigger is about YY ms.

Physics Process	low- $p_T$	high- $p_T$
$p/K$ decays	3.1	0.06
$b$ decays	1.0	0.09
$c$ decays	0.5	0.05
$W \rightarrow \mu\nu$	negligible	0.05
cavern background	negligible	negligible
<b>Total</b>	<b>4.6</b>	<b>0.24</b>

### 13.4.3 Tau/leptons/ $E_{\text{miss}}$

A major Standard Model source of tau leptons in ATLAS will arise from  $W/Z$  decay sources:  $pp \rightarrow W \rightarrow \tau\nu$  ( $\sigma \sim 19$  nb) and  $pp \rightarrow Z \rightarrow \tau\tau$  ( $\sigma \sim 3$  nb). The overall tau production rate from this source is of the order of 10 Hz, at low luminosity. The tau lepton will also play a key role in the search for new physics. For example, in the MSSM the heavy scalar (H) and pseudoscalar (A) Higgs boson decays to a tau-pair are strongly enhanced with respect to Standard Model Higgs boson case. The dominant process in the high  $\tan\beta$  ( $\geq 15$ ) region is  $gg, q\bar{q} \rightarrow b\bar{b}A/H \rightarrow \tau\tau$  and for low values of  $\tan\beta$  rates for  $gg \rightarrow A/H \rightarrow \tau\tau$  are dominant. Also, a key decay channel for the charged Higgs boson is  $H^\pm \rightarrow \tau\nu$ . In minimal SUGRA models the lighter tau slepton is expected to be the second lightest superparticle over a large parameter range at high  $\tan\beta$ . Consequently, one expects a viable SUGRA signal involving taus originating from tau slepton decay.

The identification of the hadronic decays of Tau leptons is based on the selection of narrow isolated jets with low multiplicity in the tracking system. The shower isolation and shape are calculated for both the e.m. and hadronic calorimeters separately. The fraction of energy deposited by the tau-jet in the e.m. calorimeter has a mean value around 60%. The hadronic shower is broader in the hadronic calorimeter than in the e.m. calorimeter. Thus the jet information obtained from the e.m. calorimeter is more selective than that from the hadronic calorimeter. At LVL1 the tau trigger described above would have similar inputs and much of the same logic, as the electron/photon trigger.

Missing transverse energy will provide a distinct and important signature for new physics at the LHC. Many elements of physics beyond the Standard Model e.g. the production and decay of SUSY particles, the production and decay of the Higgs boson, require a good measurement of  $E_{\text{miss}}$ . One example is the possible production of the  $A/H$  bosons which then decays via the process,  $A/H \rightarrow \tau\tau$ . A precise and reliable measurement of  $E_{\text{miss}}$  requires good calorimeter performance and energy resolution, good linearity of response and hermetic coverage.

One of the basic building blocks of the LVL1 calorimeter trigger is the  $E_T$ -sum in the calorimetry. The total scalar  $E_T$ , as well as its components, are computed in the Jet/Energy sum processor of the calorimeter trigger. An  $E_T$ -miss trigger is not implemented in the basic LVL1 inclusive triggers. However, it is an important part of the trigger when placed in combination with the tau/hadron, electron photon, single jet triggers. A high level  $E_T$ -miss trigger is applied at the Event Filter level only, where access to the complete event, after calibration, is available. At this stage one can combine tau and  $E_T$ -miss triggers as one would in an offline analysis program, for example in the search for MSSM Higgs production in the channel  $A/H \rightarrow \tau\tau$ .

(Presumably there will be more or different words when I get feedback from Giacomo and the ETmiss group, LLP)

### 13.4.3.1 The First Level Tau Trigger

The motivation for a LVL1 tau calorimeter trigger is threefold. First, it could improve the efficiency for triggering on the process  $Z^0 \rightarrow \tau^+\tau^-$  or on low mass  $A \rightarrow \tau^+\tau^-$  on decays, in coincidence with an electron or a muon trigger. Second, it could provide a trigger on  $A \rightarrow \tau^+\tau^-$ ,  $W \rightarrow \tau\nu$  and  $Z \rightarrow \tau\tau$  decays, in coincidence with missing  $E_T$ . Third, using the measured momentum from the tracking system, it could be used to select high- $E_T$  hadronic tau decays for calibration of the hadron calorimeter. Narrow tau jets containing 1(3) tracks give rise to narrow isolated energy depositions in the calorimetry. It is envisaged that an isolation requirement will be a valuable part of the trigger for the first and second trigger types mentioned above.

The  $e/\gamma$  hadron/tau LVL1 algorithms are described in detail elsewhere [13-38] and [13-39]. The LVL1 Tau/Hadron calorimeter trigger is based on a  $4 \times 4$  array of "trigger towers" in the electromagnetic and hadronic calorimetry (within the region  $|\eta| < 2.5$ ) where the tower granularity is  $(0.1 \times 0.1) \Delta\eta \times \Delta\phi$ . A core  $E_T$  is defined in the trigger algorithm as the sum of the electromagnetic and hadronic  $E_T$  in a  $2 \times 2$  trigger tower. The trigger algorithm is based on four elements: the trigger cluster(s), an e.m. isolation region, a hadronic isolation region and an "ROI cluster". The requirements for a window to be accepted as containing a valid trigger objects are: at least one of the four  $(1 \times 2/2 \times 1)$  trigger clusters passes the "e.m. cluster threshold"; the trigger cluster formed from  $2 \times 2$  hadronic towers pass the "hadronic cluster threshold".  $E_T$  sums in the e.m. isolation and hadronic isolation regions are less than the corresponding isolation threshold; and the centre  $2 \times 2$  ROI cluster is a local " $E_T$  maximum", i.e. is more energetic than the 8 neighbouring clusters of the same type contained in the  $4 \times 4$  trigger window. The hadron isolation requirements are defined as follows. First, the total  $E_T$  in the e.m. isolation region is less than the 12-tower e.m. "ring" isolation threshold; second, the total  $E_T$  in the outer hadronic isolation region is less than the 12-tower hadronic "ring" isolation threshold. A schematic description of the first level tau/hadron trigger is given in Figure 13-3.

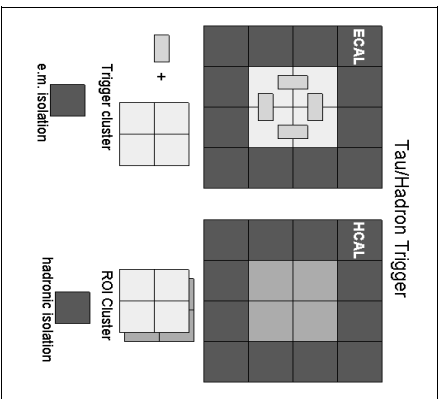

Figure 13-3. A schematic view of the tau/hadron LVL1 trigger algorithms

Although the tau/hadron LVL1 trigger is very similar to the  $e/\gamma$  hadron slice LVL1 trigger there are two important differences. First, there is  $2 \times 2$  "hadronic cluster threshold" requirement not present in the  $e/\gamma$  hadron LVL1 trigger. Second, in the  $e/\gamma$  hadron LVL1 trigger there is an inner hadronic,  $2 \times 2$  tower, isolation threshold requirement that is not present in the tau/hadron trigger. The tau/electron trigger utilizes the full  $e/\gamma$  hadron slice machinery described previously. The signal selection is tuned using events of the type  $Z^0 \rightarrow \tau^+ \tau^-$ . Background evaluation is performed using fully simulated di-jet events.

The LVL1 selection signatures studied will be  $(XX + XEYY)$  (we will start with the LVL1 trigger menu item is  $(Z25 + XE30)$  assuming that we have access to the LVL1 Emiss trigger in the software) and  $(ZZ)$  (we will try  $(Z50)$  initially).

The results of the analysis detailing the precise cuts and isolation thresholds at LVL1 will be placed here in tabular form. JLP

### 13.4.3.2 The Second Level Tau Trigger

The LVL2 tau trigger involves the verification of the LVL1 decision and tau identification using parameters that describe the shower shape and the isolation of the narrow jet. Additional rejection of background jets can be achieved by using the information from tracks associated to the tau ROI. Again, the signal selection is tuned using events of the type  $Z^0 \rightarrow \tau^+ \tau^-$ . Background evaluation is performed using fully simulated di-jet events. The LVL2 algorithm is

applied to LVL1 tau ROIs. Loose LVL1 cuts are chosen for the study presented here: a cluster  $E_T$  in excess of  $XX$  GeV is required, and e.m. and hadronic isolation thresholds are set to  $XX$  GeV. Jet calibration is applied to the cells within the LVL1 ROI window. The energy weighted position of the tau-jet candidate  $(\Delta\eta, x \Delta\phi_c)$  is computed from all calorimeter cells within the LVL1 window. The first part of the LVL2 algorithm is the confirmation of the LVL1 decision. In order to do this the LVL1 algorithm described above is executed except that fine grained cell information is utilized and no threshold is applied to the trigger towers. At LVL1 this threshold is  $X$  GeV.

The next step in the LVL2 is to look at core energy and isolation. The performance of the algorithm is studied for several choices of e.m. core size:  $\Delta\eta \times \Delta\phi = 0.1 \times 0.1, 0.15 \times 0.15, 0.2 \times 0.2$ , where the core window is centred at the energy weighted position,  $(\Delta\eta_c, x \Delta\phi_c)$ . The hadronic core size is chosen to be the same as LVL1 i.e.  $\Delta\eta \times \Delta\phi = 0.2 \times 0.2$ . Isolation windows and thresholds are defined separately for the e.m. or hadronic parts as the complement of the respective core and the  $0.4 \times 0.4$  ROI region. In order to avoid the loss of high energy taus relative energy fractions were considered. The quantity considered here is fraction of e.m. energy in the core. A previous analysis [13-19] has required that: the e.m. plus hadronic transverse energy contained in a small core is required to be above 50 GeV; and, the fraction of e.m. energy in the core is required to be greater than 85%. Results of the study of performance as a function of the core size studied for various values of the integrated efficiency for jets, etc., etc will be included here. JLP)

The next stage of the LVL2 algorithm is to select tracks within a window of  $\Delta\eta \times \Delta\phi = 0.4 \times 0.4$  centred at the tau cluster. Only tracks above a  $p_T$  threshold ( $X$  GeV or  $Y$  GeV) are used. We require exactly one track, or one to three tracks within the window. Assuming 100% tracking efficiency and requiring track  $p_T$  to be above  $X$  GeV and  $1 \leq N_{trk} \leq 3$ , the jet rate is reduced by approximately a factor of  $XX$ , while keeping the tau efficiency close to  $XX\%$ . The reduction of jets can reach approximately a factor of  $YY$  when exactly one charged track is required, but in this case the tau efficiency is reduced to  $ZZ\%$ . Inefficiency in track finding reduces the jet rejection power as well as the tau efficiency. However, the effect is small for realistic values of track efficiency (~90%): about  $X\%$  increase in jet rate and  $Y\%$  decrease in tau efficiency. If a higher  $p_T$  cut is chosen, say,  $p_T > 5$  GeV, then the rejection power for jets is significantly diminished, with little effect on the tau efficiency. Thus, the capability to measure low  $p_T$  charged tracks at LVL2 will be important for tau/jet separation.

(A table of tau and jet efficiencies after a cut on the number of generated charged tracks, when applied to LVL1 ROIs and after LVL2 tau selection will be given here. JLP)

Electron identification at LVL2 is described previously in section xxx of this document. It is based upon the matching of a track reconstructed in the inner detector, including TRT hits, with the electron cluster in the calorimetry. This machinery will be used to identify tau/electron jets at LVL2.

### 13.4.3.3 Tau Selection in the Event Filter

At the event filter stage we have access to the complete, calibrated, event for the first time. Thus, it is possible to refine the LVL2 decision. Existing offline studies of tau/hadron identification and jet rejection [13-40] provide the basis for the event filter (EF) trigger decision. The trigger criteria for tau/hadron jets with  $E_T > XX$  GeV and  $|\eta| < 2.5$  are as follows:

- The jet radius computed using only the e.m. cells contained in the jet,  $R_{em}$ , must obey the inequality:  $R_{em} < 0.0X$  (0.07 in [13-40]).



- The difference between the  $E_T$  contained in cones of size  $\Delta R = 0.X$  and  $0.Y$  ( $0.2 \ \& \ 0.1$  in [13-40]), normalized to the total jet  $E_T$ ,  $\Delta E_T$ , must obey the inequality:  $\Delta E_T < 0.Z$  ( $0.1$  in [13-40]);
- The number of reconstructed charge tracks  $N_{tr}$  is equal to 1 or 3, pointing to the cluster (within  $\Delta R = 0.X$ )

(In the case of the tau/hadron trigger three additional tau selection requirements will be studied (if there is time) Tracks must be extrapolated to "hit" a hadronic cluster i.e. must satisfy  $R < 0.X$  ( $R^2 = \Delta\phi^2 + \Delta\eta^2$ ), where  $R$  is the "distance between the cluster centre and the extrapolated track position at the hadron calorimeter." 2) All tracks must be consistent with originating from the same event vertex as the cluster. That is,  $\Delta z$  between the distance of closest approach of the hadronic shower direction and the track at the closest approach to the beam obeys the inequality:  $\Delta z < xx$  cm; 3) There must be rough agreement between the sum of the hadronic  $E_T$  measured in the calorimetry and the sum of  $P_T$  measured in the tracking; JLP

In the case of the tau/lepton trigger the cuts employed are: The  $P_T$  of the lepton is required to be greater than  $XX$  GeV and  $|\eta| < 2.5$ .

A method of improving the signal acceptance for final states involving taus as well as retaining an acceptable trigger rate is combining a tau trigger with an  $E_T$ -miss trigger. The corresponding HLT menu item is (r35+x+E45). Using XXXXX di-jet events the probability for a QCD jet to satisfy the tau identification criteria is studied. The corresponding tau identification efficiency was investigated using  $Z^0 \rightarrow \tau^+\tau^-$  produced at low and high luminosity.

(The results of the studies discussed above will be presented here. JLP)

### 13.4.4 b-tagging

The selection of b-jets at trigger level can improve the flexibility of the HLT scheme and possibly extend its physics performance. In particular, for topologies containing multi b-jets, the ability to separate b-jets from light quark and gluon jets could increase the acceptance for signal events (if the use of lower jet  $E_T$  thresholds than those discussed in section XXX is feasible) or reduce the background (and hence the rate) for events containing b-jets that have already been selected by other triggers.

The study presented in this section defines and characterizes, in the low and in the high luminosity case, an online b-tagging selection based on the information coming from the Inner Detector.

#### 13.4.4.1 B-tagging at LVL2

The track reconstruction and the precise determination of the track parameters (in particular in the transverse plane  $d_0$ ) are the crucial components for the b-jet trigger.

Several tracking algorithms for LVL2 have been presented in Section YYY. Table 12-1 shows the comparison of the track reconstruction efficiency, the track parameters resolution and the latency among the different algorithms for Rols generated by b-jets in the low and high luminosity case.

The b-tagging algorithm is based on the significance of the transverse impact parameter  $S = d_0 / \sigma(p_T)$ . A b-jet estimator is build using the likelihood-ratio method: for each track (i), the ratio of

**Table 13-3** Comparison of the track efficiency, the track parameter resolution and the time latency for different tracking algorithms in low (high) luminosity case.

	IDSCAN	SITRACK	...
Track efficiency	xx(yy)	xx(yy)	xx(yy)
Fake track fraction	xx(yy)	xx(yy)	xx(yy)
$\sigma(d_0)$	xx(yy)	xx(yy)	xx(yy)
$\sigma(\phi)$	xx(yy)	xx(yy)	xx(yy)
$\sigma(p_T)$	xx(yy)	xx(yy)	xx(yy)
$\sigma(\eta)$	xx(yy)	xx(yy)	xx(yy)
$\sigma(z_0)$	xx(yy)	xx(yy)	xx(yy)
Execution time	xx(yy)	xx(yy)	xx(yy)

the probability densities for the track to come from a b-jet or a u-jet is calculated:  $f_b(S)/f_u(S)$ ; the product  $W$  of these ratios over all reconstructed tracks in the jet is computed and the final tagging variable  $X = W / (1+W)$  is defined. Jets are tagged as b-jets if  $X > 1$  and u-jets if  $X < 0$ .

#### 13.4.4.2 Results on single b-jet tagging

The b-tagging algorithm has been characterized on single b-jets coming from  $H \rightarrow b \bar{b}$  decays with  $m_H = 120$  GeV produced in association with a  $W$  at low and high luminosity, and corresponding u-jets obtained by artificially replacing the b-jets from the Higgs decay. The  $E_T$ -spectrum of these jets covers the range up to  $E_T = 120$  GeV; they provide a good benchmark for many physics channels involving Higgs production.

The efficiencies for b-jets ( $\epsilon_b$ ) and rejection factors ( $R_u$ ) against u-jets are given in Table 12-2.

**Table 13-4** Rejection of the LVL2 b-tagging algorithm against u-jets for three different values of the b-jet efficiency: 50%(top), 60%(middle) and 70%(bottom). The results are shown for different intervals of  $E_T$ ,  $\eta$  of the jet.

	$E_T < 40$ GeV	$40$ GeV $< E_T < 80$ GeV	$80$ GeV $< E_T < 120$ GeV
$ \eta  < 1.5$	xx	xx	xx
$ \eta  > 1.5$	xx	xx	xx

#### 13.4.4.3 Comparison with Offline b-tagging

The performance of the LVL2 trigger algorithm has been compared to that of the offline algorithm.

The Figure 12-X demonstrates that the trigger and offline selection are well correlated and that, as long as the LVL2 efficiency is kept above XX%, it is possible to provide subsequent analyses with an unbiased sample in the region  $\epsilon < XX\%$ .

Different combinations of working points of LVL2 trigger selection and offline analysis could be chosen depending on the required offline b-tagging efficiency.

### 13.4.5 B-physics

About one collision in every hundred will produce a  $b\bar{b}$  quark pair. Therefore, in addition to rejecting non- $b\bar{b}$  events, the B-trigger must have the ability to identify and select those events containing B-decay channels of specific interest. Important areas include CP-violation studies with the channels  $B_d \rightarrow \pi^+ \pi^-$  and  $B_d \rightarrow J/\psi \pi^+ \pi^-$  and  $B_d \rightarrow J/\psi \pi^+ \pi^-$ ; measurements of  $B_s$  oscillations in  $B_s \rightarrow D_s \pi^+$  and  $B_s \rightarrow D_s \pi^0$  with  $D_s \rightarrow \pi^+ \pi^-$ ; analysis of  $B_s \rightarrow J/\psi \pi^+ \pi^-$ ; rare decays of the type  $B_{d,s} \rightarrow \mu^+ \mu^- X$ ; b-production measurements and precision measurements with B-hadrons. Since these are precision measurements and searches for rare decays, high statistics are required. The large number of  $b\bar{b}$  pairs produced at the LHC mean that ATLAS is well placed to make a significant contribution in these areas.

Since the Technical Proposal the B-trigger has been re-assessed in the light of a number of developments, including the likelihood of a reduced ID layout at the start of running, an increase in the target start-up luminosity and various trigger deferral scenarios. The aim is to provide the maximum possible coverage of key B-physics channels within the available resources.

It is important to study a range of scenarios since the actual start-up conditions are uncertain. Luminosity is expected to vary from fill-to-fill, and there are uncertainties in the physics cross-sections and in the calculation of required resources. A flexible trigger strategy has, therefore, been developed based on a di-muon trigger at the start of higher luminosity LHC fills and introducing further triggers later in the beam coast or for lower luminosity fills (over the period of a beam-coast the luminosity is expected to fall by about a factor of two). Two strategies have been investigated for these additional triggers, as follows.

- Require a LVL1 JET or EM Rol in addition to a single-muon trigger ( $p_T > 8$  GeV). At LVL2 and the EF, tracks are reconstructed within Rol using pixel SCT and TRT information. The reconstructed tracks form the basis of selections for e.g.  $J/\psi(ee)$ ,  $B(\text{cp})$  and  $D_s(\phi\pi)$ . Since track reconstruction is performed inside Rol, the resources required are modest.
- A full-scan of the SCT and pixels is performed for events with a single-muon trigger ( $p_T > 8$ -GeV). The reconstructed tracks form the basis of selections for e.g.  $B(\text{cp})$  and  $D_s(\phi\pi)$ . This promises better efficiency than the above method, but requires somewhat greater resources in order to perform the full-scan.

In all cases, at least one LVL1 muon trigger is required to initiate the B-trigger. Since the cross-section for inclusive muon production from pion and kaon decays falls more rapidly with  $p_T$  than that for prompt muon production from b-decays, an appropriate choice of  $p_T$  threshold gives a powerful reduction of the trigger rate due to background processes. For example, a threshold of  $p_T > 8$  GeV would give a single-muon trigger rate of 10 kHz at LVL1 for a luminosity of  $1 \times 10^{33} \text{ cm}^{-2} \text{ s}^{-1}$ . Most of this rate is due to muons with true  $p_T$  below threshold originating from pion and kaon decay, a large proportion of which can be rejected at LVL2 on the basis of more precise track measurements. After the LVL2 selection the trigger rate is about 2-kHz at a luminosity of  $1 \times 10^{33} \text{ cm}^{-2} \text{ s}^{-1}$ , about one third of this rate is due to  $b \rightarrow \mu$  decays. It is important not to set the muon  $p_T$  threshold too high as this would significantly reduce the statistics in the signal channels and render the measurements un-competitive.

#### 13.4.5.1 Di-muon triggers

A di-muon trigger provides a very effective selection for several important channels, e.g.  $B \rightarrow J/\psi(\mu^+ \mu^-) K_S$  and  $B \rightarrow \mu^+ \mu^- (X)$ . The LVL1 muon trigger is efficient down to a  $p_T$  of about 5 GeV in the barrel region and about 3 GeV in the end-caps. However the actual thresholds used for the di-muon trigger will be determined by rate limitations. For example, a  $p_T$  threshold of 6 GeV would give a di-muon trigger rate of about 600 Hz after LVL1 at a luminosity of  $2 \times 10^{33} \text{ cm}^{-2} \text{ s}^{-1}$ . These triggers are mostly due to muons from heavy flavour decays plus some single muons which are doubly counted due to overlaps in the end-cap trigger chambers. The latter are removed when the muons are subsequently confirmed at LVL2 using information from the muon precision chambers and ID. At the EF, tracks are refit and specific selections made on the basis of mass and decay length cuts. These consist of semi-inclusive selections, for example to select  $J/\psi(\mu^+ \mu^-)$  decays with a displaced vertex, and in some cases exclusive selections such as for  $B_{d,s} \rightarrow \mu^+ \mu^-$ . The final trigger rate, after the EF, is about  $\sim 20$  Hz at a luminosity of  $2 \times 10^{33} \text{ cm}^{-2} \text{ s}^{-1}$ .

#### 13.4.5.2 Hadronic final states

For hadronic final states, two strategies have been studied based on, for events with a muon trigger, either an ID full-scan or a Rol-based selection. An ID full-scan consists of track-reconstruction within the entire volume of the SCT and Pixel detectors <Ref [tdscan]> and, optionally, the TRT <ref TRTscan>. The alternative strategy uses low  $E_T$  LVL1 jet clusters to define Rols for track reconstruction in the ID. By limiting track reconstruction to the part of the ID lying within the Rol, about 10% on average, there is potential for up to a factor of ten saving in execution time compared to the full-scan. Preliminary studies of efficiency and jet-cluster multiplicity have been made using a fast simulation which includes a detailed parameterization of the calorimeter. These studies indicate that a threshold of  $E_T > 5$  GeV gives a reasonable jet cluster mul-

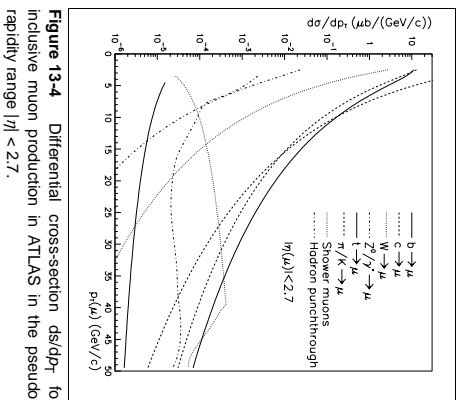

Figure 13-4 Differential cross-section  $d^2\sigma/dp_T d|\eta|$  for inclusive muon production in ATLAS in the pseudorapidity range  $|\eta| < 2.7$ .

tiplicity, i.e. a mean of about two RoI per event for events containing a muon with  $p_T > 6$  GeV, see Fig. <jet roi Mult>. A trigger based on this threshold would be efficient for  $B \rightarrow D_s \pi$  and  $B \rightarrow \pi \pi$  events with a B-hadron  $p_T$  above about 15 GeV.

Following the ID track reconstruction (either full-scan or RoI-based) further selections are made for specific channels of interest. These are kept as inclusive as possible at LVL2 with some more exclusive selections at the EF. For example, samples of  $B_s \rightarrow D_s \pi^+$  and  $B_s \rightarrow D_s a_1$  events can both be triggered by selecting events containing a  $D_s(\phi \pi^+)$  candidate.

Tracks are refit at the EF inside RoI defined from the results of LVL2. Using LVL2 to guide the EF reconstruction reduces the amount of data to be processed. For example, a region encompassing all LVL2 tracks forming  $D_s(\phi \pi)$  or  $B(\pi \pi)$  candidates corresponds to about 10% of the ID acceptance, on average. At the EF, tighter mass cuts may be applied than at LVL2, due to the better track parameter resolution obtained from the EF reconstruction. In addition, EF selections may include decay vertex reconstruction, allowing further cuts on vertex-fit quality and decay length.

Studies using a full detector simulation have shown that an efficiency of about 70% can be obtained for  $B_s \rightarrow D_s \pi$  signal events where all final state particles have  $p_T > 1.5$  GeV. The corresponding trigger rate is about 60 Hz at LVL2 and about 6 Hz after the EF at a luminosity of  $1 \times 10^{33} \text{ cm}^{-2} \text{ s}^{-1}$ , using a single muon trigger threshold of  $p_T > 8$ -GeV. There is very little degradation of the trigger performance if the number of pixel layers is reduced from three to the two layers expected at the start of LHC running.

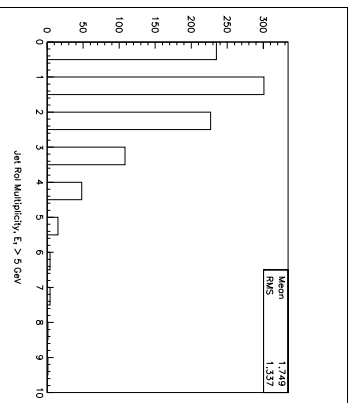

Figure 13-5 Jet ROI multiplicity ( $E_T > 5$  GeV) for events with a muon  $p_T > 6$  GeV.

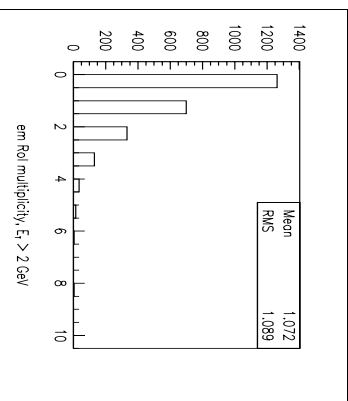

Figure 13-6 EM ROI multiplicity ( $E_T > 2$  GeV) for events with a muon  $p_T > 6$  GeV.

### 13.4.5.3 Muon-electron final states

A muon-electron trigger is used to select channels such as  $B_d \rightarrow J/\psi(e^+e^-)K_s$  events with an opposite side muon tag, or  $B_d \rightarrow J/\psi(l^+l^-)K_s$  with an opposite side electron tag. As for the trigger for hadronic final states, two different strategies have been studied using either an ID full-scan or RoI-based ID track reconstruction. In both cases a LVL1 muon trigger, confirmed at LVL2, is required.

For the full-scan based method, a histogramming technique <Ref\_TRTUT,Ref\_xKahman> is used to search for tracks within the entire volume of the TRT. Good efficiency has been obtained for electrons with  $p_T$  down to about 1 GeV. However, since execution time scales as  $1/p_T$ , in practice higher thresholds may be used. To improve track parameter resolution, track candidates reconstructed by the TRT are then extrapolated into the SCT and pixels using a Kalman filter algorithm <Ref\_Sikahman>. The TRT identifies  $e^+e^-$  candidates on the basis of transition radiation information. Candidates passing track cuts are combined in opposite charge-sign pairs and  $J/\psi(ee)$  mass cuts applied. An efficiency of about 40% can be obtained for  $B_d \rightarrow J/\psi(e^+e^-)K_s$  events where both  $e^+$  and  $e^-$  have  $p_T > 1$ -GeV. The corresponding LVL2 trigger rate is about 40 Hz, at a luminosity of  $1 \times 10^{33} \text{ cm}^{-2} \text{ s}^{-1}$ , using a  $p_T > 8$ -GeV muon trigger threshold. The tracks are refit at the EF, including a vertex fit. Decay length and fit quality cuts are applied, giving about a factor of ten further reduction in trigger rate.

An alternative strategy is based upon using the LVL1 trigger to find low  $E_T$  electron/photon clusters which define RoI to be investigated at LVL2. Preliminary studies, using a fast simulation, show that a reasonable compromise between RoI multiplicity and electron efficiency might be obtained with a threshold of  $E_T > 2$  GeV. This gives a mean RoI multiplicity of about one for events containing a muon with  $p_T > 6$ -GeV, see Fig. <EM ROI mult>. The corresponding efficiency to create a RoI for both the  $e^+$  and  $e^-$  from  $J/\psi(e^+e^-)$  is about 80% in events where both final state particles have  $p_T > 3$ -GeV. At LVL2, the electron/photon RoIs are confirmed in the calorimeter, using full-granularity information and including the pre-sampler. A search is then made, inside the RoI, for tracks in the SCT, Pixels and TRT. The RoI about each electron candidate can be quite small, of order  $\Delta \eta \times \Delta \phi = 0.2 \times 0.2$ . This gives a large saving in reconstruction time, compared to a full-scan, but has a lower efficiency, particularly at low  $p_T$ .

### 13.4.5.4 Resource estimates

In order to estimate the computing resources required for the B-trigger, measurements of execution time are combined with estimates of trigger rate at each step of the selection. Various reconstruction algorithms have been timed on several different platforms in order to determine the mean execution time at a given luminosity, and the scaling of execution time with the number of hits in an event, and hence the scaling with luminosity. These timing measurements have been combined with the estimates of trigger rates and RoI multiplicity to give an estimate of the resources required for the B-trigger [13-51]. The results are shown in Table 13-5.

Table 13-5 B-trigger resource estimates.

Luminosity	B-Trigger	no. cpu
$2 \times 10^{33} \text{ cm}^{-2} \text{ s}^{-1}$	Di-muon only	2
$1 \times 10^{33} \text{ cm}^{-2} \text{ s}^{-1}$	Di-muon + RoI-based triggers	8
	Di-muon + full-scan based triggers	26

The use of low  $E_T$  LVL1 RoI to guide reconstruction at LVL2 promises a full programme of B-physics for very modest resources. However multiplicities and efficiencies need to be verified in studies using a full detector simulation.

### 13.5 Event rates and size to off-line

Define present ideas about data compression and reduction, zero suppression for LAr (and TRT?); this might be probably be elsewhere as well. Differences between zeros at the EF and loss-less data compression in the ROSES.

Global table on rates for initial and high luminosity, implication for off-line reconstruction (costing, later)

### 13.6 Start-up scenario

Should be here? Picture a global approach on how we are going to handle, at the selection level, the first year of running, assuming a certain machine scenario. It is probably very appealing for LHCC

### 13.7 References

- 13-1 ATLAS detector and physics performance technical design report, CERN-LHCC/99-14/15 (1999)
- 13-2 ATLAS Collaboration, First-Level Trigger Technical Design Report, CERN/LHCC/98-14. ATLAS First Level Trigger, ATL-DA-ES-0029.
- 13-3 Schorner-Sadenius and T. Wengler, Formats and Interfaces in the Simulation of the ATLAS First Level Trigger, ATL-DA-ES-0003.
- 13-4 [M. Abolins et al., Specification of the LV11 / LV12 trigger interface, ATL-D-ES-0003.
- 13-5 E. Mays et al., The ATLAS Level-1 Trigger Offline Simulation, ATL-COM-DAQ-2002-021.
- 13-6 <http://xml.apache.org/xerces-c>
- 13-7 E. Eisenhandler, Level-1 Calorimeter Trigger URD, ATL-DA-ES-0001.
- 13-8 A. Watson, Updates to the Level-1  $e/\gamma$  and hadron Algorithms, ATL-DAQ-2000-046.
- 13-9 ATLAS Collaboration, more about the RPC detectors.
- 13-10 ATLAS Collaboration, more about the RPC trigger.
- 13-11 [http://atlas.web.cern.ch/Atlas/GROUPS/MUON/layout/muon\\_layout\\_P.html](http://atlas.web.cern.ch/Atlas/GROUPS/MUON/layout/muon_layout_P.html)
- 13-12 A. Di Mattia et al., A muon trigger algorithm for Level-2 feature extraction, ATL-DAQ-2000-036; A. Di Mattia and L. Luminari, Performance of the Level-1 Trigger System in the ATLAS Muon Spectrometer Barrel, ATL-DAQ-2002-008.
- 13-13 ATLAS Collaboration, High-Level Trigger Technical Proposal, CERN/LHCC/2000-17.
- 13-14 A. Di Mattia, RPC Trigger Robustness: Status Report, ATL-DAQ-2002-015.
- 13-15 S. Veneziano, Preliminary Design Report of the MUCTPI Electronics, ATC-RD-ER-0001.
- 13-16 N. Ellis, Central Trigger Processor URD, ATL-DA-ES-0003; P. Farthouat, CTP Technical Specification, ATL-DA-ES-0006.

- 13-17 G. Schuler et al., Central Trigger Processor Demonstrator (CTPD), ATL-DA-ER-0005, I. Bragun et al., A Demonstrator for the ATLAS Level-1 Central Trigger Processor, ATL-DA-ER-0008.
- 13-18 R. Blair et al., ATLAS Second Level Trigger Prototype ROI Builder, ATL-D-ES-0011.
- 13-19 S. Armstrong et al., "Requirements for an Inner Detector Event Data Model", ATLAS-TDAQ-2002-011.
- 13-20 A.G. Mello, S. Armstrong, and S. Brandt, "Region-of-Interest Selection for ATLAS High Level Trigger and Offline Software Environments", ATLAS-COM-TDAQ-2003-005, ATLAS-COM-SOFT-2003-002.
- 13-21 PESA Core Algorithms Group, S. Armstrong editor, "Algorithms for the ATLAS High Level Trigger", ATLAS-COM-TDAQ-2003-00X.
- 13-22 K. Assamagan et al., "A Hierarchical Software Identifier Scheme", ATLAS-COM-MUON-2002-019.
- 13-23 C. Leggett and A. Schafer, presentations at the ATLAS EDM-DD Workshop, 27 January 2003.
- 13-24 For more information on SCTKalman see I. Gairnes, S. Gonzalez and S. Qian, in Proceedings of CHEP2000 (Padova); D. Candlin, R. Candlin and S. Qian, in Proceedings of CHEP01 (Beijing); J. Baines, et al. ATL-DAQ-2000-031.
- 13-25 J. Baines et al., "Global Pattern Recognition in the TRT for B-Physics in the ATLAS Trigger", ATLAS-TDAQ-99-012; M. Sessler and M. Smizanska, "Global Pattern Recognition in the TRT for the ATLAS LV12 Trigger", ATLAS-TDAQ-98-120.
- 13-26 S. Stvoilokov, presentations made in PESA Core Algorithms Group meetings, December 2002 and January 2003. See also S. Stvoilokov, "High pT Level-2 Trigger Algorithm for the TRT Detector in ATRIG", ATLAS-TDAQ-2000-043.
- 13-27 M.P. Casado, S. Gonzalez, and T. Shears, TrigT2Calo package, <http://atlas-sw.cern.ch/cgi-bin/cvswweb.cgi/offline/Trigger/TrigAlgorithms/TrigT2Calo/>
- 13-28 S. Gonzalez, T. Hansl-Kozanicka, and M. Wieleers, "Selection of high-pT electromagnetic clusters by the level-2 trigger of ATLAS", ATLAS-TDAQ-2000-002.
- 13-29 S. González, B. González Pineiro, and T. Shears, "First implementation of calorimeter FEX algorithms in the LV12 reference software.", ATLAS-TDAQ-2000-020.
- 13-30 S. Gonzalez and T. Shears "Further studies and optimization of the level-2 trigger electron/ photon FEX algorithm.", ATLAS-TDAQ-2000-042.
- 13-31 ATLAS first level trigger technical design report, CERN/LHCC/98-14 (1998).
- 13-32 H. Drevemann and N. Konstantinidis, "Hit Filtering and Grouping for Track Reconstruction", ATLAS-TDAQ-2003-XXX (Document in Preparation).
- 13-33 H. Drevemann and N. Konstantinidis, "Hit Filtering and Grouping for Track Reconstruction", ATLAS-TDAQ-2003-XXX (Document in Preparation).
- 13-34 A. di Mattia et al. (Rome Level-2 Muon Trigger Group), "A Muon Trigger Algorithm for Level 2 Feature Extraction", ATLAS-DAQ-2000-036.
- 13-35 I. Gavrilenko, "Description of Global Pattern Recognition Program (skahan)", ATLAS-INDET-97-165; also see: <http://maupitf.lbl.gov/atlas/xkal/xkalmamp/index.html>
- 13-36 R. Chiffi and A. Poppoletto, IPATREC: Inner Detector Pattern Recognition and Track-Fitting, see <http://atlasinfo.cern.ch/Atlas/GROUPS/SOFTWARE/DOCUMENTS/IPATREC/ipatrec.html>.

- 13-37 The Moore Group, Moore – Muon OO Reconstruction for ATLAS, see <http://www.usatlas.bnl.gov/computing/software/moore/>.
- 13-38 ATLAS Trigger Performance Status Report, CERN/LHCC 98-15, 25th August 1998
- 13-39 A. T. Watson, "Updates to the Level-1  $e/\gamma$  &  $\tau$ /hadron Algorithms," ATLAS-DAQ-2000-046.
- 13-40 D. Cavalli and S. Resconi, "Combined Analysis of A/H  $\rightarrow \tau\tau$  Events from Direct and Associated b $\bar{b}$ A Production," ATLAS-PPHYS-2000-005, 22nd May 1998. D. Cavalli, L. Cozzi, L. Pertini, S. Resconi, "Search for A/H  $\rightarrow \tau\tau$  Decays", ATLAS-PPHYS-94-051, 22nd December 1994. D. Cavalli and S. Resconi, "Tau Jet Separation in the ATLAS Detector", ATLAS PPHYS-N0-118, 27th January 1998
- 13-41 ATLAS HLT, DAQ and DCS Technical Proposal, CERN-LHCC/2000-17
- 13-42 Performance studies for electron and photon selection at the event filter, ATLAS internal note ATLAS-DAQ-2000-007 (2000)
- 13-43 First study of the LVL2- $\mu\mu$  boundary in the high- $p_T$   $e/\gamma$  high-level-trigger, ATLAS internal note, ATLAS-DAQ-2000-045 (2000)
- 13-44 Electron trigger performance studies for the event filter, ATLAS internal note, ATLAS-DAQ-2001-004 (2001)
- 13-45 ATLAS Data Challenge 1, see <http://atlas.web.cern.ch/Atlas/GROUPS/SOFTWARE/DC/DC1/DC1-Report-VI-0-211002.pdf> (will become ATLAS-SOFT note)
- 13-46 Physics Performance of the LVL1 EM triggers, to be written
- 13-47 Performance Studies of the HLT electron triggers, to be written
- 13-48 J. Baines et. al., B-Physics Event Selection for the ATLAS High Level Trigger, ATLAS Note ATLAS-DAQ-2000-031 (2000).
- 13-49 Effects of Inner Detector Misalignment and Inefficiency on the ATLAS B-physics Trigger by: J. Baines, B. Epp, S. George, V.M. Ghete, G. Hollyman, D. Hutchcroft, A. Nairz, S. Sivoklokov, ATLAS-DAQ-2001-006
- 13-50 Event Filter Rate for the Ds Trigger, B. Epp, V.M. Ghete, A. Nairz, ATLAS-DAQ-2001-003
- 13-51 J. Baines et. al. Resource Estimates for the ATLAS B-physics Trigger ATLAS-COM-DAQ-2002-001
- 13-52 N. Konstantinidis and H. Dreverman, Fast tracking in hadron collider experiments, in Proceedings of the 7th International Workshop on Advanced Computing and Analysis Techniques in Physics Research, Amer. Inst. Phys. Conference Proceedings, Vol. 583, 2001
- 13-53 J. Baines et al., Pattern Recognition in the TRT for the ATLAS B-Physics Trigger, ATLAS Note ATLAS-DAQ-99-007 (1999).
- 13-54 I. Gavrilenko, Description of Global Pattern Recognition Program (KKalman), ATLAS Note ATLAS-INDET-97-165 (1997).
- 13-55 P. Billior and S. Qian, Simultaneous Pattern Recognition and Track Fitting by the Kalman Filtering Method, Nucl. Instr. and Meth. A225 (1990) 219.

## 14 Overall system performance and validation

### 14.1 Introduction

- Definition of validation of rate capability, its context and scope.
- Summary of validation process

### 14.2 Integrated Prototypes

Description of the prototypes:

- HLT/PESA prototype
- Integrated 10% system

#### 14.2.1 System performance of event selection

The High Level Trigger will select and classify events based on software largely developed in the offline environment. This approach minimizes duplication of effort and ensures consistency between the offline and the online event selections. However, given the strict performance requirements of a real-time online environment, it is essential to evaluate the performance of the HLT event selection software ("PESA software") in a realistic trigger environment.

The resource utilization characteristics of the PESA software are an important input to the models that predict overall system size and cost. For this reason, a prototyping program was developed to perform dedicated system performance measurements of the event selection software in a testbed environment.

##### 14.2.1.1 Measurement and validation strategy

The scope of the work reported here is limited to a system with full event selection and a minimal dataflow system, providing full trigger functionality with limited performance. Such a dedicated "vertical slice test" is sufficient to test the performance of the HLT event selection in a realistic environment. Nevertheless, even in such a limited system, tests and measurements of the dataflow aspects relevant to PESA can be performed.

An important aspect of this prototyping work is component integration. Although single components may perform very well in isolated tests, only integration with other system elements may reveal weakness not foreseen in the original design. The integration and testing work described here followed, roughly, the following steps:

1. Individual component testing and validation (addressed in Chapters 8 and 13)
2. Functional integration of relevant components (e.g., Online, Dataflow, PESA) in a small testbed, providing feedback to developers.
3. Final system validation

4. Measurement program, including event processing times, network latencies, and thread scaling.

The last three steps were carried out for a LVL2 testbed, an EF testbed, and a combined HLT testbed in the context of validating the TDAQ architecture. The following sections summarize the outcome of this integration and measurement program.

#### 14.2.1.2 Event selection at LVL2

All elements necessary to transport and process event data inside the L2PU were assembled in a LVL2 vertical slice prototype. As shown in Figure 14-2 (left), the following components were included in the prototype:

- L2PU (Described in Chapter 9.2.4)
- ROS or ROS emulator (Described in Section 8.1.3)
- LVL2 Supervisor (Described in Section 9.2.3)

The above were connected to the CERN network through a hybrid Fast/Gigabit ethernet switch, all controlled by the online software. The host machines for the applications were typically either Dual processor Pentium or Athlon machines (2.2 GHz) or single processor Pentium IV (2.4 GHz). A detailed description of the setup can be found in [14-2].

The L2PU, the application that effects the event selection, hosts both Dataflow and HLT software. In building the vertical slice prototype, the major challenge was achieving the integration of both software frameworks. As described in Section XXXX, the PSC acts as an interface between the control aspect of the dataflow and the event selection software (Section XXX). The selection software included all elements described in Chapter XXX, including the detector software necessary to assemble and decode the raw data fragments delivered by the ROS. A detailed description of the software integration within the L2PU, including problems and unresolved issues, can be found in [14-2].

The event data, generated from fully simulated samples of di-jet events and including the LVL1 trigger simulation, was loaded into the ROS before starting a run. A suite of trigger algorithms designed to select electrons and photons ran within the L2PU, together with the appropriate detector software to decode the raw data. For these tests, only the LAr and The calorimeters and the SCT/pixel detectors were used. In addition, in order to analyse the system performance of the software, the software suite was instrumented using NetLogger.

The latency distribution for processing the electron/photon selection in the vertical slice prototype is shown in Figure 14-1. INTERPRET RESULTS HERE. The total latency shown in the fig-

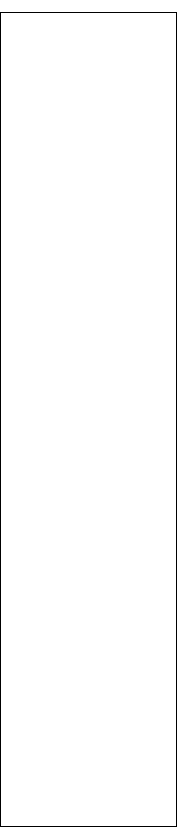

**Figure 14-1** Latency distribution for processing events in the electron/photon trigger. The left plot corresponds to low luminosity, while the plot on the right corresponds to design luminosity. In each figure, the lower portion shows the fraction of events processed as a function of time.

ure includes contributions from network latencies, raw data conversion, and algorithm execution time.

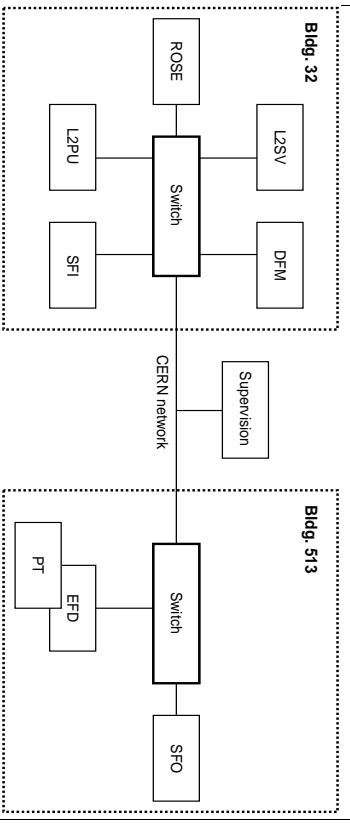

Figure 14.2 Setup for the LVL2 (left) and EF (right) vertical slice testbeds. The combined HLT testbed consisted of both LVL2 and EF testbeds connected via the CERN network infrastructure.

Here will provide a table with summary performance numbers of L2 slice. The table will present overheads per component (as in ATLAS-DAQ-2002-012) running in one thread:

- PSC+L1Result->SG
- above+dummy algorithm requesting data containers
- above-dummy+T2CALO
- above+steering
- above+IDSCAN
- above+L2result

For above, separate network latencies and PESA execution times. Compare with offline measurements.

Here describe system performance results for various components in different configurations, e.g., PSC overhead, framework overhead, algorithm usage of CPU resources, number of threads, etc. Only a few results shown in a table. The rest will be in a backup document.

Also give a sense of what sort of optimization can still be done in the software/strategy so that performance can be brought to an acceptable level.

Open issues: STL, etc.?

Address robustness requirements (runs more frequently in online than in offline)?

### 14.2.1.3 Event selection at the Event Filter

In the Event Filter, the event selection process is carried out by the processing task (ref. to chapter 9). In the first section, the baseline choice of using the offline ATHENA framework as the processing task is described, as well as the integration of the HLTSSW and ATHENA with the Event Filter. In the second section we will describe the current testbed implementation, the measurements and the validation strategy.

#### 14.2.1.3.1 The Event Filter Processing Task

In the Event Filter, the PESA strategy consists in using the offline reconstruction algorithms with the minimum set of adjustments required to comply with the performance goals. Although the full detector information is available in the Event Filter, it will not always be necessary to unpack the full event to reach the trigger decision. Hence, it should be possible to seed the algorithms, in particular with the Lvl2 result and the corresponding lazy data unpacking mechanism should be supported.

The baseline implementation choice for the Event Filter Processing Task is to use the offline ATHENA framework. ATHENA is the ATLAS concrete implementation of the underlying architecture GAUDI. The GAUDI architecture separates Algorithm Objects from Data Objects. The Algorithm view of the framework is shown in Figure 14-3. Each algorithm can access a set

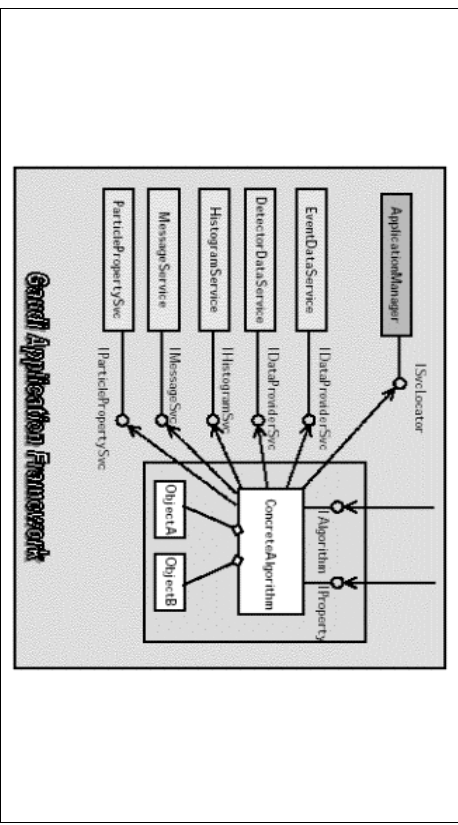

Figure 14.3 The Gaudi application framework architecture.

of services via an interface; for example the Event Data Service is accessed via the IDataProviderSvc interface. Data is exchanged between algorithms via the Transient Event Store.

The HLTSSW software is an algorithm suite steered by the Step Controller algorithm (refer to chapter XXX). While the Data Manager contributes to data preparation, all event data entities are defined in the Event Data Model. The HLTSSW is being developed in the ATHENA frame-

work. This will facilitate the development of algorithms, the adaptation of offline algorithms, the study of the boundaries between LVL2 and EF and the physics performances studies.

As we shall see to integrate the HLTSSW and ATHENA in the Event Filter will consist in making concrete implementations of some of the ATHENA services. In the Event Filter, each Processing Task consists of a standard ATHENA process, as in the offline case, that instantiates all the necessary services and runs an 'infinite' event loop.

In the following paragraphs, we will explain the event input mechanism, the production of the EFResult data fragment and how it passed to the EFDataflow, the access to the LVL2 result and the implementation of some of the services.

In the ATHENA/GAUDI concept, the infrastructure for reading from and writing to a particular persistence is provided by a conversion service (ref. Athena Developer Guide V 2.0.2). In this case the persistence is a full event in ByteStream format and the transient form are collections of Raw Data Objects while registered in the TES. The package that implements the necessary classes for a Gaudi conversion service is the ByteStreamCnvSvc. In addition, converters are responsible for converting a particular data type, in this case one for each collection type, to and from that particular persistence type.

#### Event Input

The service used to access the event is the ByteStreamCnvSvc. One of the elements of the service is the Input Source. Currently ATHENA requires each Event Input Source to implement the EventSelector and EventIterator interface. It is the EventSelectorByteStream that locates the requested ByteStreamInputSvc whose name is specified in the jobOptions. In case of running in the Event Filter farm, the specified input service is a class called ByteStreamEFDHandlerInputSvc that specifies the event source as coming from the EFDataflow. To run in offline mode instead, reading data from a file containing events in ByteStream format, is achieved simply by requesting in the jobOptions file, a different source, the ByteStreamFileInputSvc.

When running in the Event Filter farm, the ByteStreamEFDHandlerInputSvc interfaces with the EFDataflow, at initialization time, by connecting to an instance of the EFDPtrClient singleton class (refer to Chapter 9). The method ByteStreamEFDHandlerInputSvc::nextEvent requests a pointer to the next Byte Stream event in the EFD Shared Heap. It extracts the event size from its header and uses this information to construct an instance of the RawMemoryStorage class defined by the EventFormatLibrary (EFL) online package. This object is in turn used to create and return an object of type RawEvent, a typedef for an Event Filter Library FullEventFragment object that is constructed from a RawMemoryStorage instance. From this point on, the treatment of data is exactly the same if running in the EF or offline. The IdentifiableContainer used to contain the Raw Data Objects, and the corresponding converters provide a mechanism for creating the RDOs on demand.

After the HLTSSW processing is completed, its result is wrapped in an object of type EFResult which is derived from the Athena DataObject class. The ByteStreamCnvSvc is again responsible for the conversion to persistence. The list of CLIDs of objects that should be converted to persistence is declared in jobOptions. When running in the offline mode, the output service is used to simulate the events in ByteStream format; in that case the list of CLIDs of the various types of RDO collections is declared in the jobOptions. On the other hand, when running in the Event Filter farm, one needs only to append the EFResult to the original event residing in the shared memory. Hence only the CLID of the EFResult object is declared in the jobOptions.

#### Output of EF selection process

After the event filtering process, an algorithm creates the EFResult object that contains a bit pattern corresponding to the result of the selection and some more detailed information about the selection, like which trigger element and menu items have been validated. The Athena ByteStreamCnvSvc calls the EFResultByteStreamConverter that creates a ROD fragment which payload contains the bit pattern. The ByteStreamCnvSvc automatically takes care of collecting all existing ROD fragments and, using the EventFormatLibrary, constructs the Full Event Fragment. The correspondence between a ROD and its corresponding ROB / ROS / SubDetector is provide at initialization. Again there is similarity between the offline case, where the aim is to produce ByteStream format event files and the case of the Event Filter test bed. Different jobOptions will select the list of CLID for the relevant RDO collections in the first case and the EFResult CLID in the latter. The same mechanism will be used to pass back to the EF additional information contained in reconstructed objects during the selection process. For example, the TES object representing an identified electron, given the corresponding converter that serializes the information and insert it in a ROD fragment, can also be included in the Event Filter 'Sub-detector Fragment' and will be appended to the original event.

#### Access to the LVL2 result

The access to the LVL2 result is a trivial matter. The converter associated to the LVL2result object will be automatically called by ATHENA and the object created in the TES after unpacking the LVL2 'Subdetector' fragment when the first access request will be issued by one the HLTSSW algorithm.

#### Other services

Various others ATHENA services will be interfaced to the EFSupervision, like messaging, error reporting, exception handling or to Condition Database services, etc. Again, to switch running in offline mode or running in the EF farm will consist in selecting the appropriate concrete service implementation via jobOption files.

#### Conclusion

We have seen that the use of the Athena software as the EF Processing Task makes it completely transparent to switch from the offline development environment to the EF farm which was one of the important requirement. Next we have to validate that this approach meets the performance requirements of the Event Filter.

#### 14.2.1.3.2 Event Filter Prototype

To validate the choice of the ATHENA Framework for the Processing Task, an implementation of the HLTSSW running in ATHENA in the Event Filter has been prototyped in the Magni Cluster (ref. to XXXX).

The strategy of validation consists in running some of the most relevant triggers in terms of rates: the electron trigger and the muon trigger. Efforts have been directed to the electron trigger first. The HLTSSW suite for electron identification is run starting with ByteStream data files corresponding to single electrons and dijet events, the main background source. The files have been simulated offline and the result of the LVL2 selection in form of a LVL2 'Subdetector' fragment is included.



The current HLTSSW selection suite includes tracking and calorimeter reconstruction adapted from the offline electron identification software. The interface to the EF Dataflow Pfcilent described in the above section has been implemented. For now, the EFResult object contains a set of bits matched to the decision of the selection process: 'Accept', 'Reject', 'PredeclAccept', 'Error'. No additional reconstructed objects are serialized in the current test. The implementation of the services are the following:

- The message service simply writes to a log file specific for each PTrask (name declared in JobOption file and known by the EFSupervision)
- The histogram service is interfaced to the Web based histogram service (refer to section XXXX??)

Validation procedure:

1. The basic log files are monitored by the Supervision has a simple monitoring and debugging tool.
2. For timing measurement, the TrigTimeAigs package is used. This allows to compare timing measurement done offline with the ones made in the test bed. It should be pointed out, that there is a complete decoupling between latency due to the EFDatflow and the latency of the ATHENA and HLTSSW selection process. One the pointer to the Shared-Heap is passed to Athena there is no difference between that case and the offline case where the ByteStream has been read from a file and copied in the local memory. Comparing the two modes, running with equivalent processors, allows to measure the additional overhead that could arise when running, in the offline case, in an uncontrolled farm environment. The latency in the EF that may result when the request is issued for a new event can be measured with a dummy PT. This complete decoupling will not be true any more when the database access at run time will be enabled. This is not included in the current test.
3. The histogramming package is exercised. Histograms are produced by the various processing tasks and are collected by EF Supervision.
4. The EFResult will be appended to the original Event. These events are analysed and their content compared to the result of processing the same events offline.

#### 14.2.1.4 The HLT vertical slice

The LVL2 trigger and the Event Filter were integrated in a single testbed as shown in Figure 14.2. The LVL2 slice (described in Section 14.2.1.2) and the EF slice (described in Section 14.2.1.3) were connected to form an 'HLT vertical slice' using the CERN network infrastructure. The DPM and the Event Building were located geographically close to the event fragment sources. In order to pass the LVL2 result to the EF, one of the ROSes was configured as a PROS (described in Chapter 8 ??). The entire system was configured and controlled by the Online software using the CERN network.

During the tests, the ROSes were pre-loaded with LVL1-preselcted events. NEED TO ADD RESULTS HERE.

## 14.2.2 The 10% prototype

### 14.2.2.1 Description of the 10% tested

In Chapter 8, "Data-flow", the performance of the individual components in the ATLAS Data-Flow system has been presented. These components, when operated together, carry out the functions of RoI collection and Event Building. The performance for these two functions using independent subsystems has also been presented in that chapter. The final ATLAS Data Collection system requires simultaneous operation of RoI collection and event building. This section describes results obtained from a testbed with a size of approximately 10% of the final system, with full data collection functionality. Although the testbed necessarily is a scaled down version of the final system, individual components have been operated at rates similar to those expected in the final system. The primary aims of the 10% testbed are to demonstrate full functionality of the data collection in both the LVL2 and the EB subsystems simultaneously and to check for possible interference between the subsystems. The latter is especially important with respect to the choice to be made between a switch or bus based ROS. The testbed results have also been used to calibrate and validate computer models of components and systems. The approach taken is to assure that the measured performance of 10% systems can be successfully reproduced prior to drawing conclusions from modelling full size systems. Finally, the testbed results have been used to study possible ways to achieve a staged approach to a full size system by the progressive installation of components.

The first testbed studies have been done with a single Data Collection application and associated test environment. Next, small setups with one instance of each Data Collection component, aimed at demonstrating functionality, were used. Studies with more complex setups of either EB or LVL2 subsystems followed. The largest testbed inherits from the previous ones and represents about 10% of the final system. It's organization, as presented in Figure 14.4, reflects the architecture of the final system.

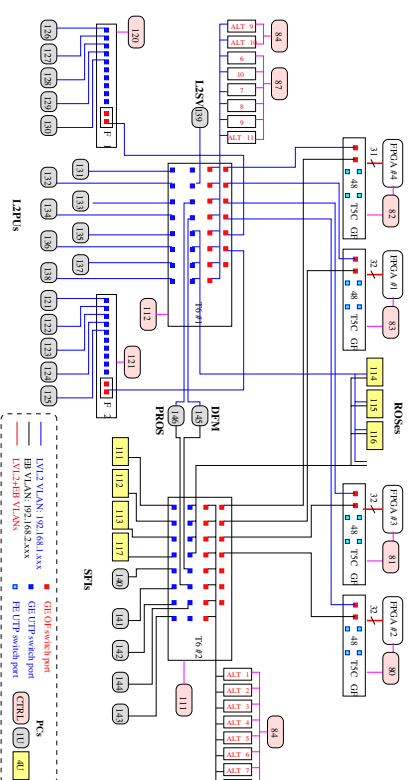

Figure 14-4 Organization of the 10% tested

The central part of the 10% testbed consists of two central switches. The central switch T6 #1 has been assigned to the LVL2 subsystem whereas the central switch T6 #2 plays the central role in the EB subsystem. Both central switches are 32 port all-Gigabit Ethernet switches (fbre-/UTP ports). For the final system the possibility of installing more central switches is foreseen. For example the number of central switches can be four when ROB concentrating switches with four uplinks are used. The consequences of using more than one central switch per subsystem have been studied in the testbed and the performance has been measured. This could be achieved in a straightforward way as the functionality of the processing nodes is defined by the type of application executed: changing it from SFI to L2PU, or vice-versa is possible by reloading appropriate software into a PC.

In the LVL2 subsystem (T6 #1) some of the processing nodes are attached directly to the central switch (nodes 131 - 138), and some via the LVL2 grouping switches (F-1 and F-2 in Figure 14-4). For the final system it is planned to connect LVL2 processing nodes via the LVL2 grouping switches, but for the testbed not enough LVL2 grouping switches (like F-1 or F-2) were available. Therefore PCs running the L2PU application were connected directly to free ports in the central switch in order to produce more traffic in the LVL2 subsystem.

In the EB subsystem PCs 111-113, 117 and 140-143 act as SFIs directly connected to the EB central switch. The current paper model predictions assume 80 SFIs for the final system, the number of SFIs installed in the testbed amounts to 10% of the final system.

Three options have been explored with respect to how the detector data stored in the ROBs are accessed. The FPCA ROB emulators (FPGA #1 - FPGA #4) allow to study the option of using ROBs with individual network access via Fast Ethernet connections. This option is described in more detail in the [ATLAS TDAQ Switch-based architecture note reference]. The ROBs are connected to concentrating switches (4 \* T3C). Each concentrating switch has two uplinks, connected to the central switches. The second option studied consists of readout of the data via bus-based ROS PCs. In the testbed PCs act as bus-based ROS emulators (114-116), (perhaps someone could provide more details, or at least a reference to the bus-based ROS.?). In the third option two or more ROBins share a single network connection, as in the prototype ROBin. For this option ROB/ROS emulators are used based on programmed Ethernet Gigabit NICs (ALTI-8 and ALI7?). Depending on the software loaded, the ROB/ROS emulator can reply with either individual ROBin data, or produce reply messages with data from a number of ROBins. The hardware emulators (FPGA and Alteon NICs) allow to output the data from a number of ROBins. Therefore with only a limited number of emulators (128 FPCA channels and tens of Alteons) the data from more than 1600 ROBins can be provided.

The architecture with the two central switches and the ROB concentrating switches creates Ethernet loops. The Spanning Tree algorithm is used to switch off the redundant links and VLANs are used to avoid changing the configuration of the testbed. As at the time of writing the Data Collection applications did not support VLANs on a single network interface, the DFM and the LVL2 Supervisor (the two applications which communicate across VLANs) were connected with two network interface cards to the EB and LVL2 central switches respectively.

#### 14.2.2.2 Description of measurements

The organization of the measurements with the 10% testbed aimed at having the components running at the nominal rates, as required for the final system. The basic quantities measured are the rate and the latency (time needed for producing a LVL2 decision or completion of event building).

Possible packet loss in the full size system is a source of concern. Therefore the effectiveness of the traffic shaping schemes used by the LVL2 and EB subsystems (the SFI uses credits to limit the number of requests into the network, while the L2PU limits the number of worker threads working in parallel) to avoid packet loss have been studied.

The amount of network resources (ports and switches) necessary for operation of the full size system is presented in [ATLAS TDAQ Switch-based architecture note reference]. In this document 60% Ethernet link utilization is assumed. In the testbed, the limited number of network resources (switches) limits the rates and throughputs. In the tests processing applications running at their nominal rates have been added until the network became a bottleneck. Then the traffic generated on the links was reduced to 60% of their nominal rate and it was verified that this safety margin guarantees the absence of packet loss.

Simultaneous operation of the EB and LVL2 subsystems as well as of multiple instances of the EB subsystem and of multiple instances of the LVL2 subsystem have been studied.

For each configuration separate measurements were done with either the FPCA ROB emulators, the Alteon ROB emulators, or the PC ROS emulators delivering data to the tested subsystem(s). Also measurements were done with all available ROB emulators delivering data. For the configuration without the LVL2 subsystem all processing nodes were loaded with the SFI application and the DFM was set into autorun mode (this avoids the need to communicate with the LVL2 Supervisor to get lists of accepted events). For the configuration without the EB subsystem all processing nodes were loaded with the L2PU application and the Supervisor was set in autorun mode (the Supervisor generates LVL1 accepted events without communication with the LVL1 subsystem). Also for simultaneous operation of the LVL2 and EB subsystems the Supervisor was set in the autorun mode and communicated to the DFM lists of accepted events for which the Event Building is necessary. The interference of the two subsystems when accessing the ROB buffers was investigated measuring the effect of changing the number of accepted events sent in the list from the Supervisor to the DFM on the maximum event rate.

#### 14.2.2.3 Results

Distributions for the event building latency and maximum event building rate measured as a function of the number of credits in the SFIs are presented in Figures. .... These measurements were done with the testbed configured for event building only (i.e. without LVL2 traffic) using both central switches and with each of the three different types of emulators separately and with all types simultaneously active. Discussion of results to be added. Forward reference to discussion in Section 14.5.1 on comparison with model predictions.

#### PLACE-HOLDER FOR RESULTS FROM EB-ONLY TESTBED CONFIGURATION

Distributions for the RoI building latency and maximum RoI handling rate measured as a function of the number of threads in the L2PUs are presented in Figures. .... These measurements were done with the testbed configured for LVL2 triggering only (i.e. without EB traffic) using both central switches. Discussion of results to be added. Forward reference to discussion in Section 14.5.1 on comparison with model predictions.

#### PLACE-HOLDER FOR RESULTS FROM LVL2-ONLY TESTBED CONFIGURATION

Distributions for the RoI building latency and maximum RoI handling rate, event building latency and maximum event building rate are presented in Figures. .... These measurements were done with the testbed configured for both LVL2 triggering only and event building. Discussion

of results to be added. Forward reference to discussion in Section 14.5.1 on comparison with model pre-conditions.

#### PLACEHOLDER FOR RESULTS FROM LVL2+EB TESTBED CONFIGURATION

### 14.3 Functional tests and test beam

During prototyping phases, often the performance of a system is put in foreground with respect to its stability and maintainability. Functional user requirements have in this phase of development a lower priority than the achievement of the performance requirements. This is to some extent true also for the TDAQ system, which has focused its efforts in the area of trigger rates, speed of data acquisition, etc. Nevertheless we have decided to also stress the global functionality of the TDAQ system, by carrying out a series of functional tests and exposing the system to non expert users at the ATLAS test beam sites.

Three different aspects of the functionality have been covered:

- a) Dynamic system configuration
- b) Stability in cycling through TDAQ finite states
- c) Operational monitoring and system recovery in case of errors

All these aspects have first been tested in dedicated laboratory setups and then verified in a 'real' environment, during test beam data taking.

- a) A TDAQ system has to be easily reconfigurable in order to accommodate the substitution of hardware, the change of trigger conditions, etc. This means that on one side all the tools to keep the configuration parameters in a database have to be developed and on the other side that the Run Control, DataFlow and Trigger software has to be designed to be dynamically reconfigurable.

To verify the flexibility of our system the following tests have been carried out:

- -substitution of a data taking machine
- - exclusion and reinsertion of a Run Control branch
- -change of communication protocol between the ROS and the L2/EF (= change of Data Collection protocol)
- -change of run parameters.

More detailed test description and measurement results to be included here.

- b) When performing a series of measurements with different configuration options, the TDAQ system must be capable of cycling through its finite states stably. This functional requirement has been checked via automated scripts cycling repeatedly through the finite state machine.

More detailed test description and measurement results to be included here.

- c) In a distributed system such as the TDAQ it is important to constantly monitor the operation of the system. Furthermore, the fault tolerance is a fundamental aspect of its functionality. In this area several improvements are still to be achieved, but we decided to carry out a series of tests in order to assess the present performance of the system in case

of errors. In particular we tried to test the fault tolerance of the system in the presence of a fatal error which prevents on or more data taking computers to continue their working.

- Verification that all applications provide regular information on their status
- -Failure of a SFO
- -Failure of a EF subfarm (distributor or collector)
- -Failure of a EF processing task
- -Failure of a SFI
- -Failure of a L2PU
- -Failure of a DFM
- -Failure of a L2SV
- -Failure of the Rol builder
- -Failure of a ROS
- -Failure of a ROBIN
- -Failure of a ROL
- -failure of online sw servers (ls, mrs, ipc, ...)

More detailed test description and measurement results to be included here.

The results of the various tests will determine the summary and conclusions of this section. It is premature to indicate them now.

### 14.4 Paper model

Estimates of average message frequencies, data volumes and the amount of processing power required have been made with the help of the "paper model". Due to the Rol driven nature of the LVL2 trigger and the different processing sequences and associated data request patterns, a "back-of-the envelope" calculation on the basis of the LVL1 and LVL2 accept rates and average event fragment sizes is not feasible. The quantities of interest have in the past been calculated with the help of a spreadsheet. Due to problems with easy modification of e.g. trigger menus and processing sequences, with the extraction of the results and with checking the correctness of the computing procedures implemented, the spreadsheet has been replaced by a program written in C++. The problems mentioned are solved, as all parameters are specified in separate input files, as results output by the program, an array of tables in ASCII format, are chosen by parameters in an input file, and as the program source gives a clear overview of the computing procedures followed.

The most important results of the paper model have been presented in Chapter 2. In Appendix A a description of the model and detailed results can be found.

With the help of the paper model a direct comparison may be made between sequential and non-sequential processing in terms of the quantity of data to be transported and of the processing resources needed to execute the respective trigger algorithms (non-sequential processing refers to the scenario in which all data that possibly could be needed is requested and processed). In particular the time consuming analysis of the inner tracker data (see Appendix A) is less fre-

quently required for sequential processing. This results in sequential processing being an order of magnitude faster than non-sequential for the current processing time estimates; see Table 14-1. The table also shows the increases in RoI request rates and amount of data transport if non-sequential processing is assumed. Another benefit of sequential processing is a shorter average decision time than that resulting from non-sequential processing.

**Table 14-1** The relative increase in request rates, LVL2 data volume and size of the LVL2 farm if non-sequential instead of sequential processing is used.

	Low luminosity	Design Luminosity
LVL2 total request rate (all ROBins)	1.7	1.9
LVL2 total data volume	1.4	2.0
Number of LVL2 PCs	6.2	13.5

## 14.5 Computer model

Because a full scale testbed is not feasible only simulation with a "computer model" can provide information on the dynamic behaviour of the full system. Computer models have been developed to get answers to very basic and fundamental questions like throughput and latency distribution of the LVL2 and EB subsystems when operating together; queue development in various places in the system (switches and end-nodes) and to study the impact of various traffic shaping and load balancing schemes. Also the interaction between multiple instances of the LVL2 subsystems and between multiple instances of the EB subsystems has been studied.

Computer models of small test set-ups have been developed and have been used for characterizing the behaviour of system components. Also models of testbeds and of the full system have been developed. The type of simulation used for the computer models is known as "discrete event simulation". Basically the simulation program maintains a time-ordered list of "events", i.e. points in time at which the simulated system changes state in a way implied by the type of "event" occurring. Only at the time of occurrence of an event the modelled system is allowed to change its state. In most cases only a small part of the state of the simulated system needs to be updated. The state change can result in the generation of new events for a later time, which are entered at the correct position in the list. The simulation program executes a loop in which the earliest event is fetched from the event list and subsequently handled.

The model of the trigger/DAQ system implemented in the simulation programs is an object-oriented model, in which most objects represent hardware (e.g. switches, computer links, processing nodes), software (e.g. the operating system, Data Collection applications) or data items. The models of the hardware and software items were kept as simple as possible, but sufficiently detailed to reproduce the aspects of their behaviour relevant for the issues studied. Parameterized models of all Data Collection applications [reference to the DC notel and Ethernet switches [reference to DC notel on parameterization of switches] have been developed. The calibration of the models of the Data Collection applications was determined by analysing time stamps. These were obtained with the help of code added to the Data Collection software (for this purpose a library based on access to the CPU registers was developed). The time stamps provided estimates on the time spent in various parts of the applications. The calibration obtained in this way was cross-checked with measurements performed in specialized setups with the application tested running at maximum rate. Parameterized models of the switches were

obtained with the help of dedicated setups. In these setups use was made of hardware traffic generators. The aim was to find any possible limitations in the switches which may affect the performance required for the full ATLAS trigger/DAQ system. The process of identification of appropriate models and a corresponding set of parameters and of collection of the parameter values with the help of dedicated setups was iterative and interleaved with validation phases. In the validation phases larger setups were modelled. Discrepancies between results from modelling and measurements usually led to a modification in the model(s) and associated parameters and another calibration phase.

Two simulation programs have been used, the *at2sim* program and the *Sindaq* program. The *at2sim* program makes use of the general purpose simulation environment of the Prolemy system. Prolemy offers support for discrete event simulation and allows the implementation of object-oriented models. The *Sindaq* program is a dedicated C++ program, with the discrete event simulation mechanism a part of the program. The component models used in the *at2sim* program are based on testbed components and calibrated as described above. The component models in the *Sindaq* program are less specific.

### 14.5.1 Results of testbed models

The testbed configurations for which results have been presented in Section 14.2.2 have been modelled. In Figures, ... model predictions and measurement results are compared, ... agreement is observed. Discussion to be added.

#### PLACEHOLDER FOR COMPUTER MODEL RESULTS OF TESTBEDS

### 14.5.2 Results of extrapolation of testbed model and identification of problem areas

The availability of network connections and switches with sufficient bandwidth and of a sufficient amount of computing resources in the DAQ and HLT systems is not sufficient to guarantee that the performance requirements are met. Also necessary are:

1. an even distribution of the computing load over the available computing resources,
2. minimal congestion and large enough data buffers in switches,
3. sufficient spare processor capacity and network bandwidth to cope with fluctuations.

The computer models of the full system can be used to identify possible problem areas.

The full system model implemented in *at2sim* is the ATLAS network-based architecture with 1564 ROBins with individual network connections (ROBins of which the data is not used in the LVL2 trigger have not been taken into account). The LVL2 subsystem is composed of 180 L2PUs connected to two Gigabit Ethernet LVL2 central switches in two groups of 90. The L2PUs are connected to the central switches via Gigabit Ethernet L2PU grouping switches with 7 L2PUs attached to the same switch. The EB subsystem is composed of 80 SFTs connected in two groups of 40 to two Gigabit Ethernet EB central switches. The SFTs are connected directly to the EB central switches. The L2Super, DFNI, PROS are connected via a dedicated small Gigabit Ethernet switch to the 4 central switches. The ROBins are connected via concentrating switches with 4 links to the central switches. The ROBins were grouped as in the full size ATLAS: groups of ROBins from a subdetector connected to a number of concentrating switches. The number of

concentrating switches per subdetector depends on the average fragment size produced by ROBns from a given subdetector (calculations are presented in the network-based architecture note). In total there were 46 concentrating switches. Results were obtained for the following configurations:

1. "individual ROBIn FE": each ROBIn has a single Fast Ethernet connection to a concentrating switch, this reflects the configuration in the 10% testbed with the BATM13Compact switch
2. "individual ROBIn GE": each ROBIn has a single Gigabit Ethernet connection to a concentrating switch.
3. "2 ROBInns aggregate": "4 ROBInns aggregate": "6 ROBInns aggregate": two, four or six ROBInns are assumed to share a single network connection, a single request produces a response with a size two, four or six times larger than the response of a single ROBIn, the number of ROBInns connected to a concentrating switch is a factor of two, four or six smaller than for individually connected ROBInns

The traffic generated in the model resembles the traffic in the final system: the LVL2 subsystem was running at event rate of 75 kHz and the EB subsystem at a rate of 3 kHz. The L2PUUs were making only one step: for each event data from 10 randomly chosen ECAL ROBns was requested and a decision was produced and sent to the Supervisor. The acceptance factor chosen resulted in 3 kHz event building rate). The L2PUUs were not calibrated - they were used only to provide the LVL2 traffic and get the EB latency in the more realistic environment. The SFIUs were requesting data from randomly addressed ROBns.

In the full system model implemented in Simdaq the same LVL1 trigger menus as used for the paper model are used to generate an appropriate number and type of ROIs for each event. In both models the eta and phi coordinates of the ROIs are chosen at random from the possible eta, phi coordinates (as defined by the LVL1 trigger). ROBInns are grouped together in groups of 12 in ROS units, each with two Gigabit Ethernet connections: one to a central LVL2 switch and one to a central EB switch. ROBInns of which the data is not used in the LVL2 trigger have not been taken into account. The mapping of the detector on the ROBInns is the same as for the paper model. Also the same processing times and LVL2 processing sequences are used. Average message rates and volumes and total CPU power utilized obtained from the paper and the computer model of the full system therefore should be equal within the statistical errors. The component models (processors, switches) however have not been calibrated as was done for at2sim. The main use of Simdaq therefore is for studying general trends in the behaviour of the full system with respect to building up of queues and of effects of possible choices for processor allocation strategies.

#### 14.5.2.1 Load balancing

An even distribution of the computing load can be achieved by means of a suitable strategy for assigning events to the L2PUUs or SFIUs. For example a simple and effective strategy consists of the LVL2 supervisor or DFM maintaining a record of how many events are being handled by each L2PU or SFI. As the supervisor and DFM are notified when processing is finished this should be straightforward to implement. A new event can then be assigned to the L2PU or SFI with the smallest number of events to process. Simulations of the LVL2 system have shown this to be a very effective strategy, with which high average loads of the L2PUUs are possible (reference to TPR or new results, if available).

#### PLACEHOLDER FOR COMPUTER MODEL RESULTS ON LOAD-BALANCING

e.g. results for round-robin compared to results for least-number-of-events-assigned

#### 14.5.2.2 Congestion in switches and buffer sizes

The effect of the credit based event building traffic shaping on the event building latency and queue build-up has been investigated with the configuration modelled in at2sim. The latency plot in Figure 14-5 shows that increasing the number of credits per SFI above 10 does not improve the latency for event building except for the "individual ROBIn FE" configuration. The latency for this configuration will for more than 10 credits still depend on the Fast Ethernet link transfer time, as it is unlikely that all 10 requested ROBInns will reply at the same time and the replies will form a queue in the concentrating switch for the uplink to the central switch. The shorter latency for setups with ROBIn aggregates with respect to individually accessed ROBInns is explained by the smaller number of requests to be generated per event. The CPU time for receiving replies scales with the number of frames received. The latter scales approximately with the number of ROBInns. The CPU time spent on generating requests scales with the number of ROBIn aggregates. Relative to the time required for receiving the replies the SFI can therefore exhaust the credits assigned faster than for individually connected ROBInns (the CPU time is shared between the process receiving replies and the process generating requests). This also causes longer queues in the central switch, as can be seen in Figure 14-5.

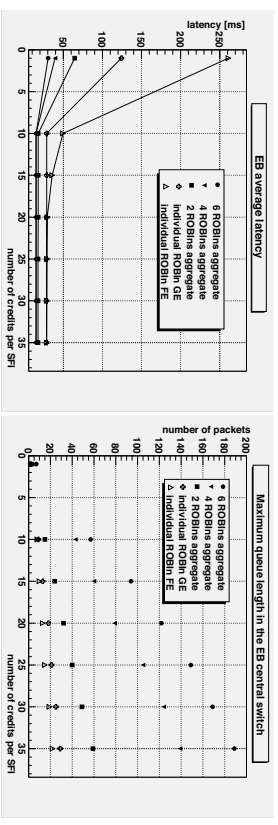

Figure 14-5 Average event building latency and maximum queue length in the EB central switches for different ROBIn configurations obtained with the at2sim full system model

More quantitative information on link and processor utilization to be added.

From Section 14.4 and from Chapter 2 it can be concluded that for the base-line architecture the total available output bandwidth from the ROS (two Gigabit Ethernet connections per ROS PC) is considerably higher than the required bandwidth (about 28 Gbyte/s vs. 6 Gbyte/s for design luminosity and a LVL1 trigger rate of 75 kHz).

Conclusion from previous result to be added.

**14.5.2.3 Spare processor capacity and spare network bandwidth**

PLACEHOLDER FOR COMPUTER MODEL RESULTS ON BUILD-UP OF QUEUES AND LATENCY AS FUNCTION OF PROCESSOR UTILIZATION

**14.6 Technology tracking**

**14.6.1 Status and Prospects**

The ATLAS TDAQ system is to a large extent comprised of off the shelf commodity equipment: personal computers (PCs) and Ethernet links and switches; the exceptions being the RoI builder and ROBns where specialized equipment has had to be developed. The technical evolution of commodity computing, communications equipment, as well as pricing, is therefore a significant element in the performance, costing and life cycle of the TDAQ system.

Impressive price and performance improvements have occurred over the last two decades. In this section we consider the prospects over the next decade, a period which covers the run up to the commissioning of ATLAS and the first few years of running.

**14.6.1.1 The personal computer market**

Moore's Law, the doubling of the number of transistors on a chip every couple of years, has been maintained over three decades, and still holds true today. Intel expects that it will continue at least through the end of this decade. In practice Moore's law has resulted in a doubling of PC performance about every two years, where performance can be quantified in terms of the clock speed of Intel's high end microprocessor chips. The computer industry has offered increasing performance at a more or less constant unit price.

For the future it seems that technically, on the time scale of ATLAS, Moore's law will continue. The only blip on the horizon being economic: the turnaround in the world economy and an unwillingness to invest the large sums of money required to deliver new generations of microprocessors.

The current performance of PC based components and systems in the ATLAS TDAQ are based on 2 GHz PCs. In estimating the performance of the system we have assumed the use of 4 GHz PCs. This is a conservative estimate. In practice the processing power needed for the VXL2 and event filter farms will be purchased in stages and will therefore be able to profit from still higher processor clock speeds. This will be particularly true for the event farms where the processing time will be long compared to the I/O time. Components in the system with high I/O requirements will also benefit from improvements in processor performance but will be more bounded by link speed. Figure 14.6 shows the performance of the DFM as a function of processor clock speed.

**14.6.1.2 Operating systems**

The Linux operating system has evolved rapidly in the last years. Many commercial companies have invested heavily in improving the operating system (BMC, HP, Sun). Currently the main

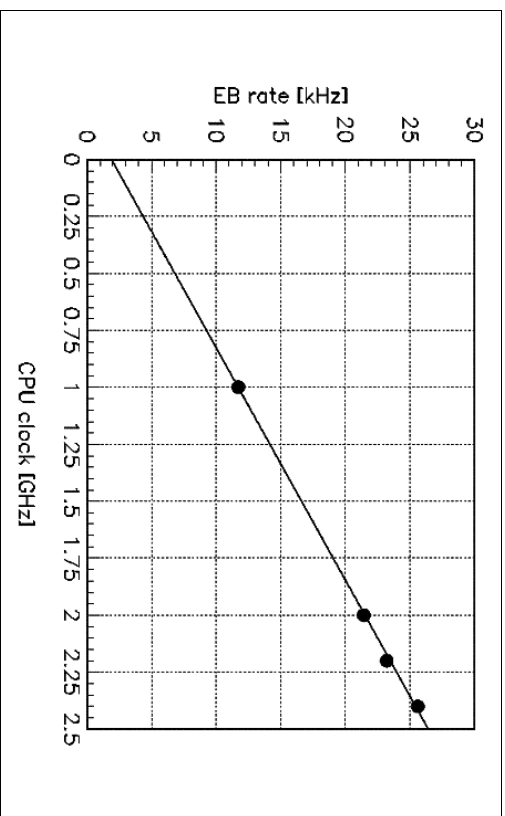

Figure 14.6 The performance of the DFM as a function of processor clock speed.

developments are in the areas of user interfaces and high-performance computing. ATLAS can clearly benefit from the Linux developments in the high-performance computing area. Such improvements include better support for multiple processors, better multi-threading and improved networking support. Practically all the new developments toward high-throughput transmission protocols over long-haul links were first implemented under Linux. Long-term, the optimization of the operating system will continue, fuelled by strong support from the academic and commercial worlds. The wide-spread usage in universities means that ATLAS will have access to qualified Linux professionals throughout the life of the experiment.

**14.6.1.3 PC Buses**

I think we have to put in something about the future of PCI bus.

**14.6.1.4 Networking**

The ATLAS baseline system uses Ethernet network technology for RoI collection and event building, as well as data distribution to the event farms. It is also used in other networks associated with control and monitoring. Ethernet is, throughout the world, the dominant local area network (LAN) technology. It has evolved from the original IEEE standard, based on a 10 Mbps shared medium, to today's point to point links running at speeds of up to 10 Gbps [14-4].

The price of Ethernet technology has followed a strong downward trend driven by high levels of competition in a mass market. Figure 14.7 shows the price of 100 Mbps (FE) and 1 Gbps Ethernet (GE) network interface cards and switch ports as a function of time. Most PCs are now delivered with a GE controller integrated on the motherboard, making the connection essentially free. Further price drops will certainly occur for GE switch ports, in line with what has hap-

pered earlier with FE. This trend is coupled to the increasing provision of a GE connection in all PCs.

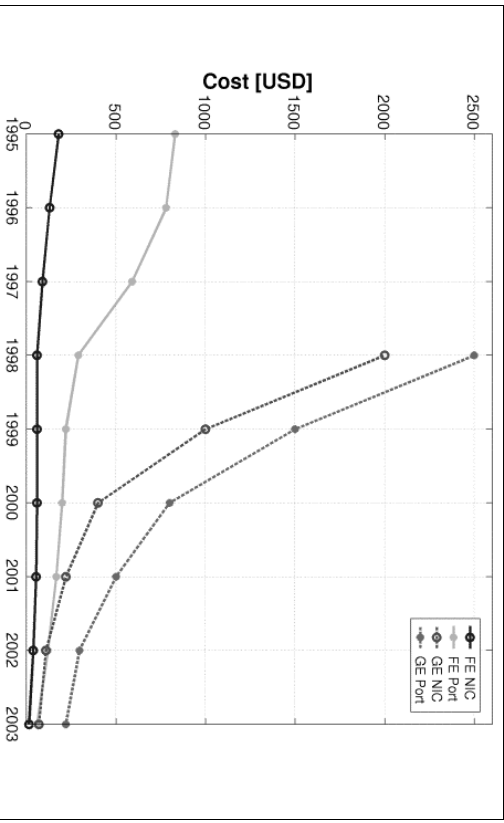

Figure 14-7 The evolution of the cost for Fast and Gigabit Ethernet switch ports and network interface cards.

The proposed baseline system can be built using Ethernet switches available today. Even the most demanding components in the system, the large central GE switches in the data collection system, are comfortably within today's norm. The prognosis for using Ethernet is therefore excellent. It is a very widely supported international standard, which meets and even exceeds our foreseeable need and will certainly have a lifetime surpassing that of ATLAS.

Consideration is being given to the use of off site computing capacity to process ATLAS events in real time. Tests made recently have shown the technical feasibility of error free Glups transmission between CERN and NBI, Copenhagen over the GEANT pan European backbone network [14-5]. Figures 14-8 and 14-9 show the setup used and some of the results obtained.

For the future, it appears technically feasible to export events at high rates from CERN to centres in member states, for processing in real time. It is within this context that 10 GE may have an important role to play. However, the use of such a scheme will ultimately depend on the economics of long haul telecommunications. This factor, as well as technical considerations and practical testing, are part of our on going program of work.

### 14.6.2 Survey of non-ATLAS solutions

(a reality-check on ATLAS approach?)

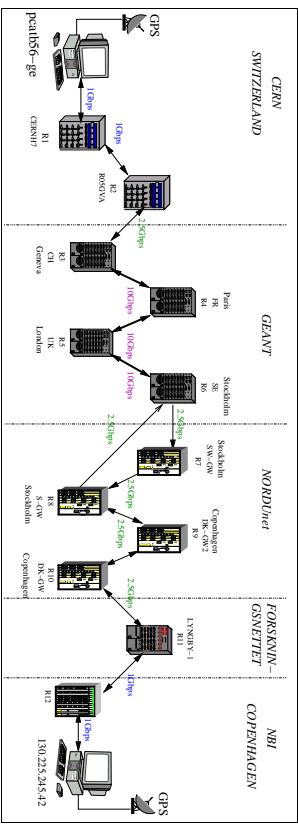

Figure 14-8 The network infrastructure between CERN and NBI (Copenhagen) over which Gbps tests have been carried out.

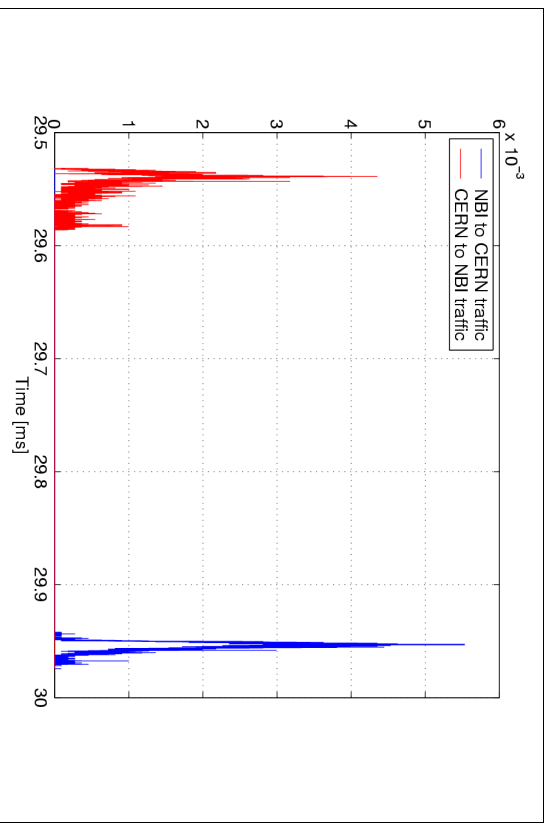

Figure 14-9 Packet latency measured between CERN and NBI (Copenhagen) at a 1 Gbps transmission rate.

### 14.7 Implication of staging scenarios

Re-interpretation of performance numbers for staging scenarios

## 14.8 Areas of concern

## 14.9 Conclusions

## 14.10 References

- 14-1
- 14-2 LVL2 vertical slice results
- 14-3 HLT vertical slice results
- 14-4 Dobinson et al RT2001 Lyon
- 14-5 Santiago di Compostella, RT2003
- 14-6



# **Part 4**

## **Organisation and Plan**

## 15 Quality assurance and development process

### 15.1 Quality assurance in TDAQ

Quality assurance during the production of hardware and software systems is provided by the adoption of a development framework for TDAQ components. The development framework consists of distinct development phases. At the end of each phase a set of deliverables is provided. For hardware, the design and specification of each element will be subject to reviews which will cover all aspects of the system design including integration issues, logistics, quality, and safety. These reviews will also provide an opportunity for QA aspects of the design to be thoroughly examined. For software, the framework is complemented by guidelines, checklists and standards, internal reviews, templates, development and testing tools, and coding standards. These are being adopted as common working practices and help with error removal and error prevention in the system.

The system is divided into many, essentially independent, subsystems. Proper functional definition of each subsystem and specifications for interconnections between them are essential to build, commission, and maintain a quality system. These definitions and specifications are described in User Requirements Documents and Interface Definitions that also specify procedures of control, testing, and maintenance as well as outlining in detail the physics performance goals of the system.

A TDAQ-wide body, the Connect Forum [15-1] assists in coordinating development process activities and quality assurance methodologies across ATLAS TDAQ/DCS. It also provides advice, especially via the recommendations and information made available through Web pages which reflect the dynamic nature of the activity. A common approach to the development via the use of rules, in-house standards, and document templates helps in building a project culture. Those rules as well as the development phases themselves are not enforced but rather aim to help developers. Emphasis on the various phases will vary and evolve with the life of the project. During event production for example, the emphasis will be put on maintenance and regular automated validation testing.

### 15.2 Hardware development and procurement

#### 15.2.1 Reviews

As noted above, hardware will be subject to a review process: the Preliminary Design Review (PDR), the Final Design Review (FDR), and the Production Readiness Review (PRR) [15-2]. The PDR will be used to examine and assess the full requirements and specifications for the system element to identify any missing functionality, to ensure full compatibility with all connecting subsystems, and to determine overall feasibility. For custom hardware this is a very important part of the review procedure, as it will determine the direction of subsequent engineering effort.

For custom hardware the FDR will be held before the design is sent for manufacture, and is intended to catch any design or engineering errors before budgetary commitment. This review

will necessarily be of a more technical nature than the initial review, but there should be few problems to detect by this stage. It will be merged with the PRR which aims to address production organization, version control, and the organization of quality control.

For components with commercial hardware to be bought in significant numbers the FDR will be held after a prototype of the component has been assembled and tested. Examples of such components are HLT sub-farm racks with a mixture of commercial items, and ROS Units with a combination of commercial and custom hardware. The role of the FDR is to check that the component fully meets the required specification.

Subsequent purchases of the component, which are likely to be in several batches, will then be preceded by a tendering exercise. This will start with a market survey to check current performances and prices, then a proposal for the precise configuration for the purchase which is reviewed by a PRR, followed by formal tendering. This process should ensure uniform configurations of PCs and local network switches within each round of purchasing, even if constraints of the different funding agencies require them to be purchased from different sources. Note, however, that in the case of HLT sub-farms where batches are purchased at intervals of typically one year, identical configurations would not be expected between batches.

#### 15.2.2 Testing

The following tests and procedures on the TDAQ hardware components will be performed to guarantee their performance to the standards required:

- Evaluate the probable frequency of repair to meet the physics goal on each subsystem.
- Evaluate the effect of failure on system components for various types of failure and design the system so that the more probable failures will cause least problems to the overall system.
- Select components for the resulting level of required reliability.
- Burn-in all essential custom boards and units to reduce initial failures to a minimum.
- Ensure that the communities possess sufficient spares for repair purposes for the entire 10 year running cycle. This will include a study of alternative components to replace those that may not be produced throughout the experiment's lifetime due to a termination of present production processes.
- Establish repair routines for the more routine failures; commercial items should have standard warranties with conditions checked at the PRR.
- Give each element a serial number: a record will be kept to store the information relative to each board: origin of the components which populate the board, date of production, results of tests, date of installation, name of the sub-detector using the board, history of failure, and actions taken.
- Test commercial items: initial test by the supplier; acceptance test by the responsible TDAQ institute.

The networking components are one type of commercial item which will be given special attention. These play a critical role within the ATLAS TDAQ system and the Data Flow network has very high performance demands specific to this application. A network tester system is being developed for the evaluation and testing of network switches. For the concentrating switches, to be purchased in large numbers, the tests of prototypes will include the use of this system. For

the central switches only very few will be purchased and a modified procedure will be required. Experience obtained from extensive tests on switches allows precise specifications to be given for these switches. These will be used to select one or more candidates which will then be evaluated with the tester to ensure that they fully meet the requirements. Once a switch is integrated into the TDAQ system, it will be managed using a commercial monitoring tool (see Chapter 7). Tests will also be made on the connecting cables to be used within the networks, in particular for possible problems with electromagnetic interference when large numbers of Unshielded Twisted Pair (UTP) cables are used.

### 15.3 The Software Development Process

The Software Development Process (SDP) in ATLAS TDAQ [15-3] provides the structure and the sequence of activities required for development. A basic framework is provided to guide developers through the steps needed during the development of a component or a system. Conventional review and modification of the SDP provides it with the flexibility to adapt to the evolution of the components and systems.

Many of the recommended approaches in the SDP are also applicable to the development of hardware components or sub-systems involving both software and hardware. The SDP consists of the following phases as shown in Figure 15-1: Brainstorming, Requirements, Architecture and Design, Implementation, Testing, Maintenance, complemented by reviews. Emphasis on the different phases will evolve with time.

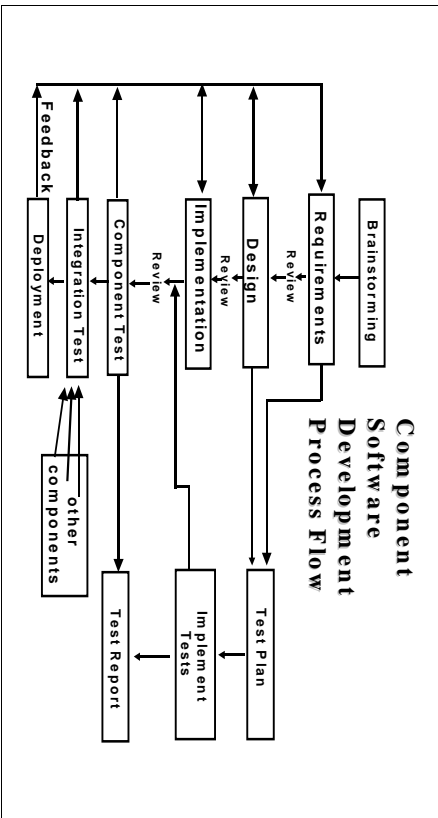

Figure 15-1 Phases and flow of the Software Development Process

#### 15.3.1 Inspection and Review

Written material including documents and code is subjected to a process of inspection and review at each step from Requirements to Implementation, in the SDP. Inspection is essentially a quality improvement process used to detect defects. The inspection process in the ATLAS

TDAQ project is based on Gilb and Graham's Software Inspection method [15-4]. An important feature of the inspection procedure is its flexibility, allowing it to evolve as needs change during the lifetime of the project [15-5].

Overall responsibility for an inspection is taken by an inspection leader who appoints an inspection team consisting of the document author and three to five inspectors. The core of the inspection process is the checking phase where the inspectors read the document in detail, comparing it against source documents and lists of rules and standards. Defects are logged in a table, where a defect is defined as a violation of any of the standards. Emphasis is placed on finding major defects which could seriously compromise the final product. The defects are discussed at a logging meeting and their acceptance or rejection is recorded in an inspection issue log. The document author edits the document according to the log making an explanatory note if an issue is rejected. Feedback is also obtained on how the inspection procedure itself may be improved.

The principal aim of inspection is to detect and correct major defects in a product. An additional benefit is the possibility to prevent defects in future products by learning from the defects found during inspection procedures. Inspection also provides on-the-job education to people new to a project and generally improves the project's working culture.

A number of Web pages have been produced which provide supporting material for inspections such as instructions for inspectors and log file templates [15-1].

#### 15.3.2 Experience

The SDP provides a disciplined approach to producing, testing, and maintaining the various systems required by the ATLAS TDAQ project. It helps to ensure the production of high-quality software and hardware which meet the requirements within a predictable schedule.

However, one of the key differences in adopting the SDP in an HEP — as opposed to an industrial — environment is that its application cannot be enforced. Furthermore, the use of such a process may appear too rigid to physicists not accustomed to working in a strong management framework. Nonetheless, the working culture can be changed by increasing awareness of the benefits of the SDP through training, for example involving new group members in inspections, and ensuring that the SDP itself is sufficiently flexible to evolve with the changing needs of an HEP experiment. This approach is working. The SDP as outlined in this section has already been adopted by a number of the sub-systems in the ATLAS TDAQ project with positive outcomes.

#### 15.3.3 The development phases

##### 15.3.3.1 Requirements

The Requirements phase [15-6] for a particular sub-system or component consists of gathering the requirements and then documenting them. Several documents have been produced to aid and control these activities, based on the early experience of some of the sub-systems. The whole process of working group setup, requirements collection, feedback and review is described in [15-6]. Another document sets out the principles governing the requirements gathering and documentation processes, stressing the importance of, for example, documentation,

evolutionary development, communication, and collective ownership of the requirements specification.

The actual process of establishing the requirements for a sub-system or component is aided by a collection of 'hints', and reinforced by a set of rules for the requirements document itself, for which a template has been provided in each of the supported documentation formats.

### 15.3.3.2 Architecture and Design

The Architectural Analysis and Design Phase of the SDP [15-7] follows the Requirements phase and takes as its starting points the User Requirements and Use Cases together with accompanying documents. This phase has sometimes been referred to as 'high-level system design'. A system's architecture is the highest level concept of that system in its environment. It refers to the organization or structure of significant components interacting through interfaces, those components being composed of successively smaller components and interfaces. A design presents a model which is an abstraction of the system to be designed. The step from a real world system to abstraction is analysis. A 'How to' note has been produced describing the overall process.

For this phase, the approach of the Rational Unified Process (RUP) is largely followed. This approach contains descriptions of concepts, artefacts, guidelines, examples, and templates. Items of the RUP have been highlighted, in particular, the descriptions of architectural analysis and design concepts, and the guidelines for producing software architecture and design documents.

The RUP template for architecture and design documents has been adapted by including explanations and making it available in supported formats. The recommended notation is the Unified Modelling Language (UML), and the design is presented in the template as a set of UML-style views. Recipes for producing appropriate diagrams and incorporating them into documents have also been prepared.

### 15.3.3.3 Implementation

The Implementation Phase of the SDP is largely concerned with writing and checking code, and producing and debugging hardware components. At the end of the implementation phase an inspection is performed.

ATLAS C++ coding conventions [15-8] are being applied to newly written code and being introduced for existing code still in evolution. In the case of Java, the outcome of the ATLAS investigation of coding conventions is awaited. DCS will follow the coding standards provided by the JCOP Framework for PVSS [15-9].

Guidelines [15-10] have been provided for multi-user, multi-platform scripting, as well as many explanations and examples in UNIX-scripting.

Experience has been gathered with a number of software tools and recommendations have been made in the areas of design and documentation [15-11], code checking, and source code management.

### 15.3.3.4 Component and Integration Testing

Testing occurs during the entire life-time of a component, group of components, or entire system. Referring to Figure 15-1, the initial test plan is written during the requirements and design phases of the component, so as not to be biased by the implementation. Since testing is likely to be an iterative process the test plan is written with re-use in mind. Once implementation is complete and passes relevant checking tools the component undergoes unit testing to verify its functionality. Compatibility with other components is verified with integration tests. Several types of tests can be envisaged for both individual components and groups of components. These include functionality, scalability, performance, fault tolerance, and regression tests.

A test report is written once each test is complete. To aid the testing procedure, templates [15-13] are provided for both the test plan and test report in each of the supported documentation formats. More detailed descriptions of the types of test, hints on testing and recommended testing tools are also provided. Testing is repeated at many points during the lifetime of a component, for example at each new release of the component software or after a period of inactivity (system shutdown). Automatic testing and diagnostic procedures to verify the component before use greatly improve efficiency.

### 15.3.3.5 Maintenance

As with testing, maintenance occurs during the entire lifetime of a component. Several types of maintenance can be envisaged. Corrective maintenance involves the fixing of bugs. Adaptive maintenance involves alterations to support changes in the technical environment. Preventive maintenance entails the restructuring and rewriting of code, or modification of hardware for future ease of maintenance. Maintenance is closely coupled to regression testing which should occur each time a maintenance action has been completed to verify that the detected problems have been solved and new defects have not been introduced. Significant changes to the functionality of the component such as the addition of large numbers of new requirements should involve a full re-iteration of the SDP cycle.

### 15.3.4 The Development Environment

Regular releases of the sub-system software to be used in test-beam operation, system integration, and large-scale tests is being complemented by nightly builds and automated tests to ensure early problem finding of newly developed or enhanced products. The use of a source code management system and of the standard release building tool CMT [15-14] allows for the building of common releases of the TDAQ system. These releases are available for the platforms used in ATLAS TDAQ which are currently a number of Linux versions and for some sub-systems LynxOS and SunOS. Build policies of different sub-systems like the use of compiler versions and platforms are co-ordinated.

Development tools like design tools, memory leak checking tools, automatic document production tools, and code checking tools are vital elements of the development environment.

## 15.4 Quality Assurance during deployment

### 15.4.1 Quality Assurance from early deployment

Deployment of the TDAQ system in test beam and during commissioning gives early feedback on the suitability of the design and the implementation of the system. It constitutes an integration test under realistic conditions in terms of functionality, reliability, and usability. Experience and findings are directed to the developers so that improvements can be made to the software and hardware concerned. A bug tracking system is in use for the reporting of software problems, their recording, and their follow-up. Complex integration aspects can be better understood and lead to adjustments in the design of components, interfaces, and strategies. The early use of the system allows the TDAQ user to become familiar with its operations and usage.

### 15.4.2 Quality Assurance of operations during data taking

The quality of the TDAQ system must be assured when it is in use during the setup and installation phase of the ATLAS data acquisition together with the detectors. Correct and smooth data taking will be aimed for during calibration and physics event production.

Quality assurance is achieved by prevention, monitoring, and fault tolerance.

- Prevention — this includes training, appropriate documentation, a well-defined development process, proper management of computing infrastructure (computer farms, readout electronics, and networks), tracing of hardware and software changes, and regular testing of components.
- Monitoring — special tasks to monitor proper functioning of equipment and data integrity: These may run as special processes or be part of the TDAQ applications. Anomalies are reported, analysed by human/artificial intelligence, and appropriate recovery action is initiated. This may include running special diagnostic code, replacement of faulty equipment, rebooting of processors, restarting of applications, re-establishing network connections, and reconfiguration to continue with a possibly reduced system. Incomplete or corrupted data should be marked in the event data stream and possibly recorded in the conditions database. Physics monitoring may lead to a change of run with different trigger conditions and event selection algorithms.
- Fault tolerance — built into the system from the start using an efficient error reporting, analysis, and recovery system as explained in Chapter 6, "Fault tolerance and error handling". Some redundancy to reduce possible single points of failure is foreseen where affordable.

During the life of the experiment small or major pieces of hardware or software will need to be replaced with more modern items, possibly using new technologies. The component structure with the well-defined functionality of each component and well-defined interfaces allowing for black-box testing according to those functionality specifications will allow the smooth incorporation of new parts into a running system, and in particular when staging of the system is required.

## 15.5 References

- 15-1 <http://cern.ch/Atlas-connect-forum/>
- 15-2 P. Farthouat, Guidelines for Electronics Design and Production Readiness Reviews, <http://cern.ch/Atlas/GROUPS/FRONTEND/WWW/designreview.pdf>
- 15-3 <http://cern.ch/Atlas-connect-forum/> - SDP
- 15-4 T. Gibb and D. Graham, Software Inspection, Addison-Wesley (1993)
- 15-5 D. Burrekhardt et al., Impact of Software Review and Inspection, CHERP2000, Padova, Italy (2000)
- 15-6 <http://cern.ch/Atlas-connect-forum/> - SDP - Requirements: Practical Steps towards an Atlas TDAQ Requirements document  
Requirements gathering and documentation 'principles'  
Hints on how to establish requirements  
Requirements Document Rules ATLAS DAQ 'in-house' rules for Requirements documents  
Requirements Document Template for Systems and Components, Software and Hardware
- 15-7 <http://cern.ch/Atlas-connect-forum/> - SDP - Architecture & Design: How-to for Design  
RUP URL for concepts  
RUP URL for guidelines  
Template for Software Architecture Document
- 15-8 ATLAS Quality Assurance Group, ATLAS C++ Coding Standard Specification, ATLAS Internal Note, ATL-SOFT-2002-001 (2002)  
<http://cern.ch/Atlas/GROUPS/SOFTWARE/OO/Development/qa/General/index.html>
- 15-9 Joint Controls Project  
<http://cern.ch/itco/Projects-Services/JCOP/>
- 15-10 <http://cern.ch/Atlas-connect-forum/> - SDP - Implementation:  
Multi-user multi-platform scripting guidelines
- 15-11 <http://cern.ch/Atlas-connect-forum/> - Tools
- 15-12 <http://cern.ch/Atlas-connect-forum/> - Templates
- 15-13 <http://cern.ch/Atlas-connect-forum/> - Testing
- 15-14 Configuration Management Tool  
<http://www.cmsite.org/>

## 16 Costing

The cost estimate of the ATLAS TDAQ system is based on a detailed model of its size (i.e. number of components) as a function of the input Level-1 trigger rate. The model is parameterized by the assumptions described in (TABLEXXX OF CHAPTER5): conservatism and safety factors are applied in particular for the performance (processing time per event and rejection power) of the HLT and the estimated unit cost of both custom (e.g. the ROBIN) and commercial components (e.g. processors). In the following are described the TDAQ system evolution from commissioning to its expected final performance, the rationale behind the costing of individual components, the subdivision of the system cost in terms of functional categories, and a summary of the expenditure profile.

Should make refs here also to the caveats on processing time which will be discussed in Chapter 14.

As for DCS the expenditure profile is still being discussed, only the total figure of 3125 MCHF is quoted. DCS is included in figures 16-2 but not yet in 16-3 (missing profile).

### 16.1 System evolution and staging

The ATLAS TDAQ system has been designed to be staged, with the size and performance of the system evolving as resources become available. The final performance corresponds to a Level-1 rate of 100 kHz. Table 16-1 indicates, for the period 2004 to 2009, the performance capability (second column) and the functional capability (third column) of the installed system. The dates of 2008 for the nominal 75 kHz system, and 2009 for the final TDAQ performance, are indicative, in so far as they depend on the availability of resources, the luminosity performance of the LHC and experience from initial running.

Table 16-1 TDAQ performance profile

Year	Sustained Level-1 rate (kHz)	Notes
2004	N/A	Pre-series only
2005	N/A	Detector & TDAQ commissioning. 75% of detector read out Use pre-series HLT farms
2006	N/A	ATLAS cosmics run Use pre-series HLT farms
2007	37.5	LHC startup 37% HLT farms
2008 <sup>a</sup>	75	Nominal LHC Luminosity 100% of detector read-out 75% HLT farms
2009 <sup>b</sup>	100	Final TDAQ performance 100% HLT farms

- a. Indicative date.  
b. Indicative date.

SECTION5.XXX discusses how the baseline architecture supports the staging of the TDAQ system. The detector read-out procured and installed in 2005-2006 is just for the non-staged part of the detector (which represents ~ 75% of the ROLs). For the purpose of uniformity, custom components, in particular the ROBIN modules, are fully procured in 2005, although part of them will be physically installed later (indicatively in the year 2008) with the staged parts of the ATLAS detector. The other parts of the ROS system are, however, procured following the staging of the detector (i.e. 75% in 2005-2006 and the remaining 25% in 2008). The strategy for staging the TDAQ system is based on the staging of the LVL2 and EF farms and, as a consequence, of the Event Builder (in particular the SFTs) and the central networks.

### 16.2 Costing of components

The majority of the ATLAS TDAQ system is based on Commercial Off The Shelf (COTS) components: commodity computer and communications hardware (e.g. PCs and Gigabit Ethernet) and related equipment. The estimated unit cost of these components is based on a conservative extrapolation of today's costs. In addition, for the HLT farms, a 30% overall safety factor is added to allow for the large uncertainties which are discussed in SECTION 14.XXX.

The unit cost of custom components, i.e. the ROBIN and RoIB, has been established on the basis of R&D prototypes.

### 16.3 Categories of expenditures

For the purpose of describing the cost and its evolution in time, the TDAQ system has been organized in terms of categories of expenditure, closely related to the TDAQ baseline architecture:

- DCS: includes the components needed for the operation of the detector and for the supervision of the infrastructure of the experiment: operator workstations, servers, detector master stations, custom modules, DSS, and control room equipment.
- Detector Read-Out: this category includes the ROBINS, the ROSS, and the related infrastructure.
- Level-2: includes the RoIB, the LVL2 Supervisor, the Level-2 processor farm, the Level-2 network, and the infrastructure.
- Event Builder: includes the DFMs, the SFTs, the Event Builder network, the SFO (with the local data storage), and the related infrastructure.
- Event Filter: includes the Event Filter processor farm, the network internal to the Event Filter, and the infrastructure.
- Online: includes processor farms for running the online software, TDAQ operations and monitoring, the central online network, and the related infrastructure.
- Other: includes items such as contributions to high speed data links in and out of the experimental area, and the acquisition of software products such as farm and network management tools.
- Pre-Series: includes a small scale version of the system for the purpose of validating the TDAQ implementation.

### 16.4 Expenditure profile and system cost

The expenditure profile is summarized in Table 16-2 and Figure 16-1. The former indicates the cost for the ATLAS TDAQ system in each year. Figure 16-1 shows the expenditure profile including its split on the basis of the categories of expenditure.

Table 16-2 TDAQ system cost profile

DCS	PROFILE UNDER DISCUSSION									Total
	Up to 2003	2004	2005	2006	2007	2008	2009			
Pre-series	1048	0	0	0	0	0	0	0	0	1048
Detector R/O	0	3049	606	0	405	0	0	0	0	4060
Level-2	0	200	880	1137	2216	915	0	0	0	5348
Event Builder	0	208	834	274	768	0	0	0	0	2048
Event Filter	0	0	1375	2863	4351	2862	0	0	0	11451
Online	0	208	622	0	0	0	0	0	0	830
Infrastructure	0	0	508	508	508	508	508	0	0	2032
<b>Total</b>	<b>1048</b>	<b>3665</b>	<b>4825</b>	<b>4782</b>	<b>8248</b>	<b>4285</b>	<b>29978</b>			<b>29978</b>

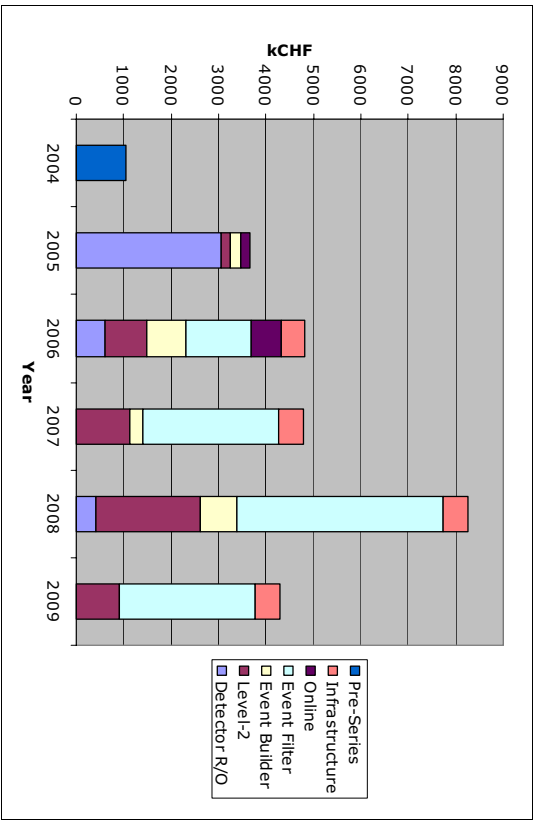

Figure 16-1 Expenditure Profile

The sharing of the cost (for the final 100 kHz system) between the categories of expenditure, is shown in Figure 16-2.

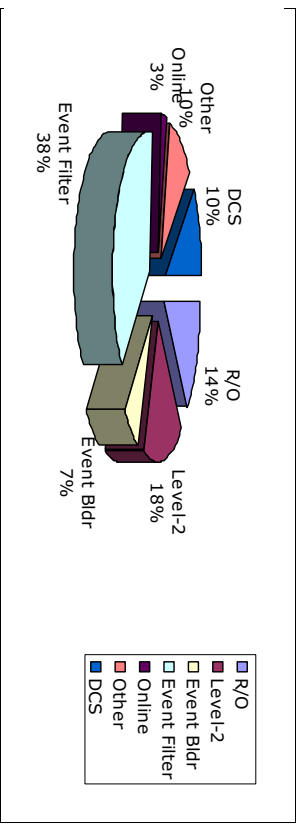

Figure 16-2 Relative cost per category of expenditure (at a 100 kHz Level-1 rate)

The total TDAQ system cost, as a function of the Level-1 rate and not including pre-series, is shown in Figure 16-3.

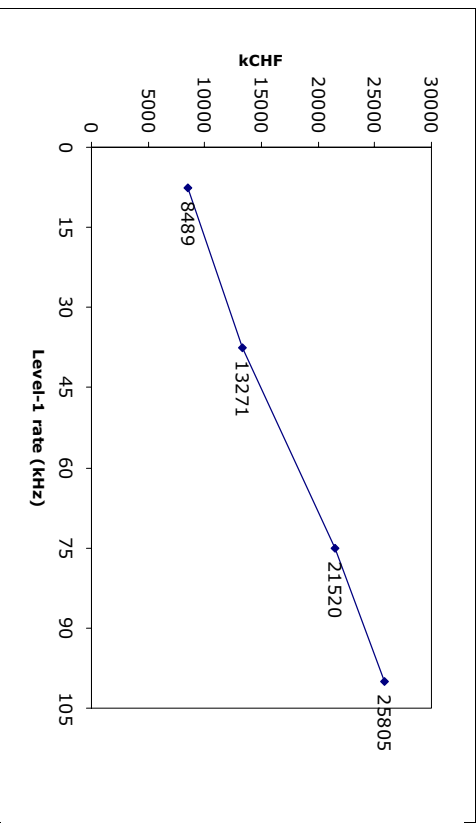

Figure 16-3 TDAQ cost versus Level-1 rate

### 16.5 References

- 16-1
- 16-2

# 17 Organization and resources

## 17.1 Project organization

The ATLAS Trigger/DAQ Project is organised in three main sub-projects: the Level-1 Trigger (Nick Ellis), the High Level Triggers (Chris Bee) and the Data Acquisition (Livio Mapelli). The management of the overall project is organised in three levels:

1. The TDAQ Management Team (TDMT), whose members are the leaders of the three sub-projects with the close involvement of the chairperson of the Trigger/DAQ Institute Board (TDIB, see Section 17.2). One of the three sub-project leaders acts as overall Project Leader on a yearly rotational basis, with the particular role of representing the project towards outside bodies.
2. The Trigger/DAQ Steering Group (TDSG), composed of the coordinators of the main sub-systems of each sub-project, the coordinators of cross-system activities and a number of ex-officio members, including the ATLAS Management and the TDIB Chair (see Figure 17-1).

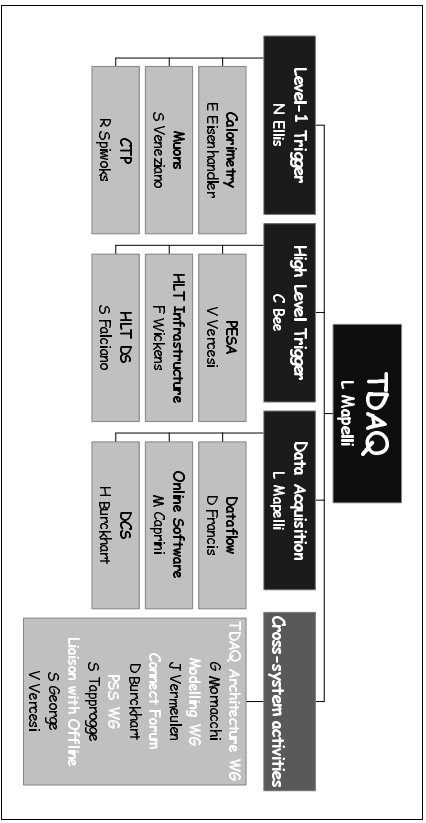

Figure 17-1: The Trigger/DAQ Steering Group (HLT DS stands for HLT Detector Slices, and PSS stands for Physics Selection Strategy)

3. Each sub-project has its own internal organization and management, tailored to the specific features and needs of the system. The organisation of the HLT and DAQ sub-projects is illustrated in Figure 17-2 and Figure 17-3. Both the HLT and the DAQ are organised in 3 sub-systems each and a number of cross-sub-system activities. The organization of the LVL1 trigger sub-project is described elsewhere [17-1].

The submission and approval process of this TDR marks the completion of most elements of the R&D phase of the TDAQ project. The project organization will be adjusted in late 2003 in order to reflect the change of phase of the project, as it moves from design and prototyping to production.

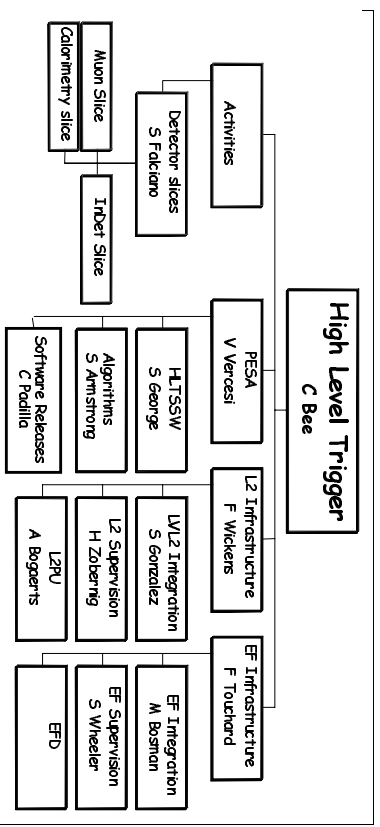

Figure 17-2: The High Level Trigger Steering Group ('Activities' are working groups cutting across the sub-systems)

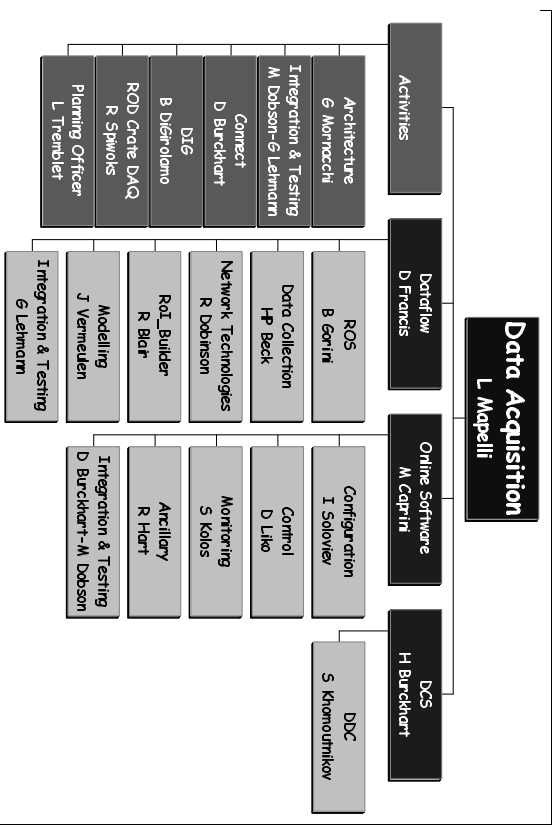

Figure 17-3: The DAQ Steering Group ('Activities' are working groups across the sub-systems, extendable to HLT and LVL1 as well)



## 17.2 Resources

The overall ATLAS Trigger/DAQ Collaboration consists of ?? Institutes, from ?? countries, ?? Funding Agencies and a total of ~?? members. The distribution of members by country is shown in [...add ref to pie chart](#).

Each institute is represented in the TDAQ Institute Board (TDIB), the policy and decision making body of the TDAQ project, presently chaired by Alejandro Nisati. Typical tasks of the TDIB include discussion and decisions on financial and human resource as well as policy making.

The TDIB is assisted by two committees, the Resource Committee and the Speakers Committee.

- **TDAQ Resource Committee (TDRC):** The TDIB is advised on finance and resource matters by the TDRC, comprising the TDMT, one member per major Funding Agency and two additional members representing collectively the other Funding Agencies. The TDRC is chaired by the TDIB chair, assisted by a Resource Coordinator (Fred Wickens).
- **TDAQ Speakers Committee:** This is a 3 member body, presently chaired by Lorne Levinson, mandated to recommend policy regarding conference speakers, to maintain a complete archive of conference presentations and to ensure a fair distribution of conference talks across the TDAQ Collaboration.

### 17.2.1 HL/TDAQ resources

The HL/T/DAQ part of the Collaboration comprises 41 Institutes, from ?? countries, ?? Funding Agencies and a total of ~?? members. Again, the distribution of members by country is shown in [...add ref to pie chart](#).

The participation of Institutes in the sub-project is summarised in Table 17-1.

## 17.3 References

17-1 ATLAS First-Level Trigger Technical Design Report, CERN/LHCC/98-14 (1998)

Table 17-1 Institute participation in the HL/TDAQ sub-projects.

Sub-system	Institutes	Coordinator
<b>HL/T</b>		
PESA	Alberta, Barcelona, Bern, CERN, Cracow, Geneva, Genova, Innsbruck, Lancaster, Lecce, London RHBNC, London UCL, Mannheim, Moscow SU, Napoli, Pavia, Prague (?), RAL, Rio de Janeiro, Rome I, Rome III, Wisconsin.	V. Vercesi
LVL2 Infrastructure	CERN, RAL, Rio de Janeiro, Rome I, Tel Aviv (?), Weizmann, Wisconsin.	F. Wickens
Event Filter Infrastructure	Alberta, Barcelona, Mainz, Marseille, Pavia, Rome III.	F. Touchard
<b>DAQ</b>		
Online Software	Bucharest, CERN, Geneva, JINR, Lisbon, NIKHEF, St. Petersburg NPL.	M. Caprini
DataFlow	Argonne, Bern, CERN, Copenhagen, Cracow, Frascati, Hiroshima, KEK, London RHBNC, London UCL, Manchester (?), Mannheim, Michigan SU, Nagasaki, NIKHEF, RAL, Rome I, Shinsu, UCI Irvine.	D. Francis
DCS	CERN, Nikhef, St. Petersburg NPL.	H. Burkhardt

## 18 Workplan and schedule

This chapter outlines the short-term (6–12 months) post-TDR workplan for the major activities in the HLT and DAQ systems (including DCS). The global HLT/DAQ development schedule is presented in Section 18.1 as the basis for the definition and context of the workplan. The detailed workplan, which is still in preparation, is introduced and a number of issues which will have to be addressed are indicated (Section 18.2). The strategy that has been developed for the detector integration and commissioning is described in Section 18.3.

### 18.1 Schedule

This section presents the overall schedule for the HLT/DAQ system up to LHC turn-on in 2007. The development and deployment of the HLT/DAQ system, both hardware and software, has been mapped onto the ATLAS detectors installation plan [18-1].

#### 18.1.1 System hardware

For the system hardware, the planning is driven by the production schedule for the two custom read-out components:

- the S-LINK Link Source Card (LSC), to be installed on the RODs;
- the ROBIN, the receiver part of the ROS (S\_LINK receiver and ROL multiplexer).

An analysis of the detector installation schedules points to the first quarter of 2004 as the moment for the Final Design Review of the LSC and the ROBIN. The review of the ROBIN requires the I/O optimization studies (see Section 18.2.1) to have been completed beforehand. (The third custom component of the HLT/DAQ, the Rol Builder, is not on the critical path for the detector installation schedule).

The global HLT/DAQ production schedule is shown in Figure 18-1. It identifies the principal milestones concerning the detector needs for TDAQ installation, the TDAQ component production (in the case of custom components), the component purchasing and associated tendering (in the case of commercial components), as well as testing and commissioning.

Figure 18.1 is a gantt chart with the principal milestones of detector installation, such as combined test beam run, commissioning, cosmic run, etc., and the TDAQ components production and purchasing schedule.

#### 18.1.2 System software

Six major releases of the system software have been identified (dates are indicative at this stage and will be adapted if necessary). The release strategy is driven by detector operations (e.g. test beams and cosmic-ray run) and commissioning (see Section 18.3).

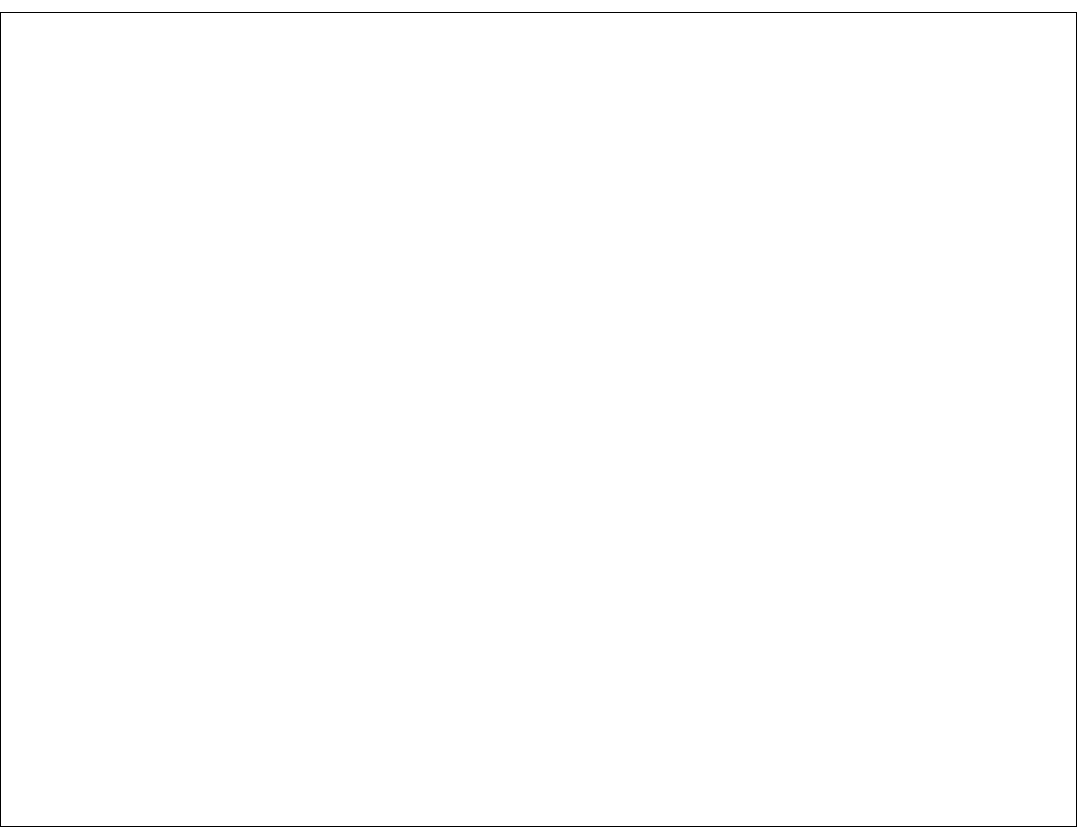

Figure 18-1 Schedule of the overall HLT/DAQ project

1. Current DAQ release, integrating Online Software and DataFlow. It is targeted at the needs of the ATLAS H8 test-beam operations in 2003 and to the I/O optimization and system-performance measurements. This release has been operational since May 2003.
2. 'Combined test-beam' release for the combined run in 2004.
3. 'Sub-detector read-out' release for initial detector commissioning with single ROD Crate DAQ (RCQD) for single crates.
4. 'HLT/DAQ installation' release for commissioning of the HLT/DAQ components and global detector commissioning in autumn 2005.
5. 'Cosmic-ray run' release for global HLT/DAQ and global detector commissioning, as well as for the ATLAS cosmic-ray run in autumn 2006.
6. 'LHC start-up' release for the start of LHC operation in April 2007.

The software-development schedule is shown in Table 18-1 for the software of the three sub-systems, Online Software, DataFlow, and High-Level Trigger. For the HLT, only the LVL2 and EF infrastructure part of the software (required for detector monitoring during detector commissioning phases) is considered here. The development schedule of the other components of the HLT software, namely the selection core software and the physics algorithms, is not linked to the DAQ releases and is not reported in the table. It will only be fully defined later this year.

**Table 18-1** Software development schedule for the software of Online Software, DF and HLT

RELEASE	Online Software	DataFlow	High Level Trigger
TDR release (Jun 03)	As described in TDR - Mar 03	As described in TDR, first full DataFlow - May 03	Current EF release - Summer 03
Combined test beam (Summer 04)	Prototype versions of control, configuration, and monitoring services - Feb 04	Consolidation of TDR release, evolution of ROD Crate DAQ - Apr 04	EF infrastructure (version from PDR) - May 04 (LVL2 infrastructure - late summer 04)
Sub-detector read-out (Autumn 04)	Full support of final ROD Crate DAQ - Jun 04	First release of final DataFlow, including ROD Crate DAQ - Dec 04	
HLT/DAQ installation (Autumn 05)	Full functionality of control, configuration, and monitoring services, including I/F to conditions DB - Apr 05	Consolidation of previous release, completion of DataFlow functionality - Jun 05	Completion of HLT functionality for cosmic-ray run - Summer 05
Cosmic-ray run (Autumn 06)	Final large-scale performance and support for particle - Mar 06	Final large-scale release - Jun 06	Ready for cosmic-ray run - Summer 06
LHC start-up (Apr 07)	Final implementation ready for tuning - Dec 06	Consolidation of previous release - Dec 06	Ready for initial physics run - Dec 06

## 18.2 Post-TDR workplan

The detailed workplan to meet the objectives described in the schedule of the previous section is in preparation and will be finalized soon after the TDR publication. Its description goes be-

yond the scope of this document, which specifically addresses the workplan of the short-term post-TDR phase, characterised by the completion of the studies for the optimization of the HLT/DAQ baseline, both in the DataFlow (Section 18.2.1) and in the HLT (Section 18.2.2). The Detector Control System workplan is outlined in Section 18.2.3, while Section 18.2.4 lists some of the other issues that will be addressed.

### 18.2.1 DataFlow workplan

In the baseline design, the flow of data and of control messages between the ROS and the HLT can be implemented using bus-based or switch-based data collection, for the aggregation of data from a number of Read Out Links into each port of the main DataFlow network. Work up to the Final Design Review (FDR) of the custom hardware in the DataFlow (first quarter of 2004) will address, with high priority, the optimization of the data flow at the ROS level.

As described in Chapter 8, a full-system prototype has been developed supporting simultaneously the two data-aggregation techniques, by means of a ROBin prototype with two Read Out Links at the input, and output to both PCI-bus and GETH (see Section 8.1.3.2). Performance measurements done on a prototype of the full HLT/DAQ architecture with a size of order 10% of the final system, as reported in Chapter 8 and Chapter 14, demonstrate the overall viability of the baseline architecture. The measurement programme is continuing with the deployment of a number of ROBin modules in the 10% prototype system, allowing a direct comparison of functional and performance aspects. This will lead to the choice of the optimal Input/Output path before the FDR of the ROBin, currently planned for the first quarter of 2004.

The results of the measurements will continue to be used in the discrete event modelling aimed at providing a description of the behaviour of the system scaled to the final size.

### 18.2.2 High-Level Trigger workplan

The work on the HLT system up to the end of 2003 will be focused on several principal areas which are discussed below.

The LVL2 and EF testbeds, discussed in Section 14.2, will be exploited during the summer period in order to arrive at a complete set of measurements concerning the functionality and performance of the HLT event-selection software. This information, together with the initial results of physics-performance studies using the selection algorithms running in the selection-software framework, will be analysed in an internal review currently planned for late October. The review will identify areas in the software which may require optimisation. Partial re-implementation, or re-design. The review will define the end of the initial cycle — requirements analysis, design, implementation, testing, and exploitation — which characterises modern software projects. The second, shorter, cycle will be launched immediately following the review with a view to completing it a year later. During this time, the system-exploitation phase will include its use in the combined ATLAS test-beam during the summer of 2004.

In parallel with the testbed exploitation, further optimization studies of the selection-software design and implementation will be done, as discussed in Section 14.2.1. The results of these studies will provide important input to the review.

Data are available from the production of large samples of simulated physics channels with noise and pile-up included. Exploitation of these data using the LVL2 and EF algorithms is now

underway in order to optimize the implementation and tune the performance of the selection algorithms in terms of signal efficiency, background-rate reduction, and execution time. This will lead to an update of the numbers presented in Refs. [18-2], [18-3] and [18-4]. Initial results are presented in this TDR. This work will continue for the rest of this year and beyond.

The HLT system software (used to control the flow of data to and from the HLT algorithms, and for the control and supervision of the HLT) is being tested in the testbeds and also, currently (in the case of the EF), in testbeam. The design and implementation of these software systems will also be reviewed towards the end of 2003 with a view to having an updated design and implementation by the middle of 2004.

The purchase of the bulk of the HLT computing and network hardware will take place at as late a date as possible compatible with ATLAS installation and commissioning requirements as well as the LHC start-up schedule. This is done to benefit from the best possible price/performance ratio of the equipment. The standard sub-farm racks, discussed in Section 5.5.11, will need to be prototyped. This work will begin later this year with a view to having a first rack prototype in 2004.

As mentioned notably in Sections 1.5 and 5.2.3.1.4, aspects of access to and use of the conditions database, and connection of the TDAC system to the offline prompt reconstruction and to CERN mass storage system are not yet sufficiently defined. These issues have already begun to be addressed with the offline computing group, and this will continue into next year.

### 18.2.3 Detector Control System workplan

The DCS schedule is summarised in Figure 18-1.

#### 18.2.3.1 Front-End

The process of producing the ELMBs has started. At the beginning of the third quarter of 2003 the radiation qualification of the components will be done, and fully-tested modules should be ready at the end of the last quarter of 2003. The software for the ELMB is being finalized and will be tested in the third quarter of 2003 before being loaded into the ELMB as part of the production process.

#### 18.2.3.2 Back-End

The Framework Software that is built on top of the SCADA software PVSS is being reviewed and the implementation of a re-designed version will start at the beginning of the third quarter of 2003 in the framework of the JCOP project. The core libraries and tools are expected by end November 2003. This final software will be used for the test-beam operation in 2004, at the ATLAS pit for controlling the sub-detectors, and the experimental infrastructure from mid-2004 onwards. In the beginning, each system will operate stand-alone. Integrated operation will be needed from the end of 2005 onwards. On this timescale, the overall supervisory system for coherent operation of the whole ATLAS experiment from the main control room will be set up. Communication with external systems will be needed in 2006 in order to allow global commissioning of ATLAS, and for the cosmic-ray run in the third quarter of 2006.

### 18.2.4 Other issues to be addressed

During the deployment of the full-system HLT/DAQ prototypes for measurements and optimization of performance, a number of other issues will be addressed which are important for the system functionality and the definition of certain services. Amongst these issues, the following have so far been identified:

- processor and process management in the HLT farms;
- flow of data in databases (for production, conditions, configuration);
- fault tolerance;
- TDAC output and computing model viz. offline prompt reconstruction and mass storage;
- use of remote EF sub-farms;
- system scalability and robustness against variation of parameters, eg LVL2 rejection power, et.

As an illustration, the last of these points is developed briefly here. The feasibility of the architecture depends on a number of assumptions regarding both external conditions (such as the data volume of a region of interest) and extrapolations of measurements performed today. Further study of the robustness of the baseline architecture with respect to reasonable, and maybe foreseeable, variations of these assumptions will be an item for the short-term post-TDR workplan.

Table 18-2 lists some of the key parameters for the architecture. For each parameter, the current value assumed is given, and consequences of the variations are discussed.

Table 18-2 Variations of baseline parameters.

Parameter	Current value	Remarks
ROL data volume	~2%	Implications on ROL-ROB aggregation factor. ROB-ROS aggregation factor, and LVL2 switch size.
ROL request rate/ ROB	Uniform distribution	This will not be the case. Non-uniform distributions have been studied extensively in Paper Models. Their implications on the traffic pattern through the level-2 network need further studies.
LVL2 acceptance	30:1	A more pessimistic figure implies a higher rate into the EB or a reduction in the maximum LVL1 rate that can be accepted, hence an effect on the ROL and ROB aggregation factors and the number of SFI's. Thus a large EB network, as well as a related impact (higher EB rate) on the EF farm size.
HLT Decision time/event	10 ms @ Level-2 1 s @ EF	Variations of O(10%) have a corresponding effect on the size of the farms and the related central (Level 2 or EB) networks.
SFI Input/Output capability	70 Mbyte/s In 70 Mbyte/s Out	Impact the size of the EB network (because of additional SFI's) Impact the organization of the EF farm. Less events output by the SFI will mean smaller sub-farms (or more SFI's per sub-farm)

## 18.3 Commissioning

During the detector installation, the corresponding read-out elements will have to be tested and commissioned. This section presents the strategy developed so that the detector commissioning requirements can be met in parallel with the commissioning of the TDAQ elements themselves. An outline of the most relevant aspects and issues of the HLT/DAQ commissioning can be added here.

The detector commissioning will be done in three phases, namely the readout of a single ROD crate, the readout of multiple ROD crates, and the readout of multiple sub-detectors. The necessary tools for the implementation of such a strategy are briefly described here. Some of these tools are already available today and used at the test beam, in test beds, and at test sites.

A more detailed description of the commissioning plan can be found in the relevant documentation of the ATLAS Technical Coordination [18-5].

### 18.3.1 Tools for detector commissioning

#### 18.3.1.1 ROD-Crate DAQ

The first need of a sub-detector will be to check the functionality of the front-end electronics via the readout FELs into ROD modules. For this first functionality check, the ROD-Crate DAQ (RCD) will be used. The RCD software is being completed now and its exploitation on test beam operations is starting. For the initial phase of detector commissioning, it will be a mature and stable product.

The RCD is the minimal infrastructure to read-out the sub-detectors' RODs. The readout will be done initially via VMEbus, by the ROD Crate Controller (RCC), as shown in Figure 18-2. Data processing can be done at the level of the RCC or in an external workstation connected via Ethernet to the RCC running the ROS application. Data in the workstation can then be stored to disk. The necessary infrastructure will be in place in the underground counting room, including the DCS, the TTC, the Local Trigger Processors, and the Conditions Database for the storage of calibration data.

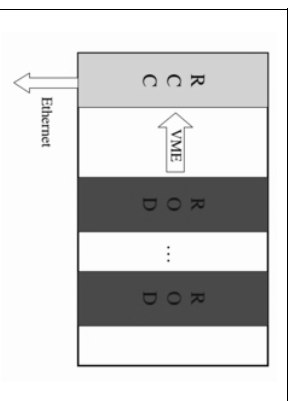

Figure 18-2 Readout of ROD modules via VMEbus by the ROD Crate Controller

The second step will implement the ROD readout via the standard Read Out Link (ROL) into a stand-alone ROS, as in Figure 18-3. This setup will enable the data integrity over the ROLs to be checked simultaneously for a number of RODs and is the first major step in the detector — DAQ integration. The setup mentioned above is very similar to the one already in use and well tested at the H8 ATLAS test beam.

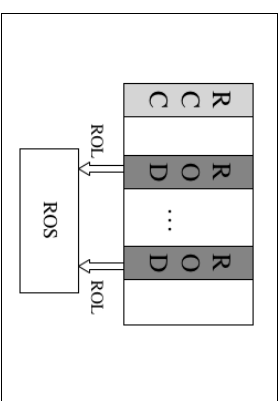

Figure 18-3 Readout of ROD Modules via ROLs connected to a minimal ROS system

#### 18.3.1.2 Readout of multiple ROD crates

In the second phase, data taking from multiple ROD crates will be implemented. This will allow the complete readout of one or more TTC partitions, requiring multiple ROS units and a minimal Event Builder. In all cases the storage of the data to disk or to the Conditions Database will be allowed (Figure 18-4).

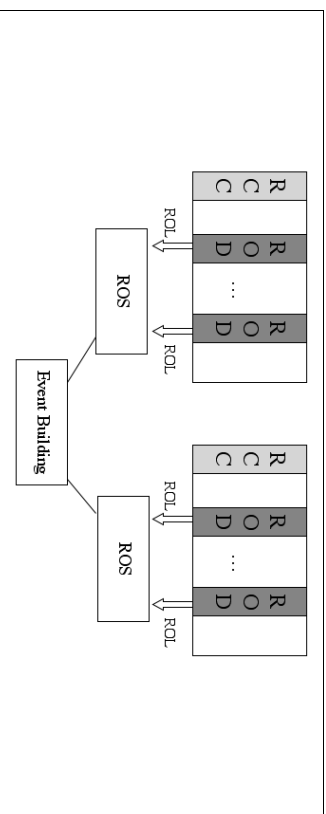

Figure 18-4 Readout of multiple ROD crates via ROLs with a minimal Event Building infrastructure

#### 18.3.1.3 Readout of multiple sub-detectors

In preparation for the cosmic-ray run and during the final phase of the ATLAS Commissioning, there will be the need for reading out several sub-detectors simultaneously. The time scale for these operations matches the time scale for the completion of installation of the final TDAQ elements. A possible configuration for the readout of more than one sub-detector is very similar to the one presented in Figure 18-4. The number of hardware elements involved may vary significantly, however the major change will be the addition of Event Filter sub-farms (only needing minimal processing power) to complete the dataflow chain. In the case of multiple sub-detector readout, the CTP infrastructure and the DCS supervisor will also be needed.

Add reference to (and some text from) the recent session at Athens on commissioning with cosmetics...

## 18.4 References

- 18-1 ATLAS installation schedule
- 18-2 ATLAS High-Level Triggers, DAQ and DCS Technical Proposal, CERN/LHCC/2000-17 (2000)
- 18-3 S. Tapprogge, Physics Requirements for the ATLAS Trigger. Presentation to LHCC Meeting, March 2002,  
<http://agenda.cern.ch/askArchive.php?base=agenda&categ=402381&id=402381s1t2/>  
transparencies
- 18-4 S. Tapprogge, ATLAS Rates. Presentation to LHCC Meeting, May 2002,  
<http://agenda.cern.ch/askArchive.php?base=agenda&categ=402443&id=402443s1t2/>  
transparencies
- 18-5 ATLAS Technical Co-ordination, ATLAS Commissioning - Sub-Detectors needs of TDAQ for readout, ATC-TD-IN-0002 (2003),  
<https://cdms.cern.ch/file/375183/1/>

## A Paper model results

### A.1 LVL1 trigger menu

The exclusive rates for the different LVL1 trigger menu items are specified in Table A-1. E.m./gamma (EM), the I refers to 'isolated'), muon (MU), jet (J) and hadron (TAU) Rols are identified and labelled with the LVL1 transverse momentum threshold. XE refers to the LVL1 missing energy trigger. For a discussion of these menus see Chapter 4, "Physics selection strategy" (NB: 5 kHz of 'Other Items' are not taken into account).

**Table A-1** Exclusive rates for the LVL1 trigger menu items. For items where two possibilities are indicated, the latter one corresponds to the design luminosity menu item.

LVL1 Trigger menu item	Low luminosity (kHz)	Design luminosity (kHz)
MU20	0.8	4.0
2 MU6	0.2	1.0
MU10 + EM151	0.1	0.4
EM251 (EM300)	12.0	22.0
2 EM151 (2 EM200)	4.0	5.0
J200 (J290)	0.2	0.2
3J90 (3J130)	0.2	0.2
4J65 (4J90)	0.2	0.2
J60 + XE60 (J100 + XE100)	0.4	0.5
TAU25 + XE30 (TAU60 + XE80)	2.0	1.0

### A.2 Event fragment sizes

Estimates of the fragment sizes are presented in Table A-2. To each fragment a ROD header and trailer (together 48 Bytes) and a ROBIN header (56 Bytes) are added. A ROS subsystem in general concatenates several fragments and then adds a 52 Byte ROS header. The Data Collection software and the network protocol will add further headers (36 Bytes for the Data Collection software, 30 Bytes for raw Ethernet with VLAN tag) which are removed on receipt of the data.

**Table A-2** Estimates of maximum data fragment sizes in bytes.

Subdetector	Number of ROLs	Participating in LVL2	Low luminosity ( $2 \times 10^{33} \text{ cm}^{-2} \text{ s}^{-1}$ )	Design luminosity ( $1 \times 10^{34} \text{ cm}^{-2} \text{ s}^{-1}$ )
Pixels	120	YES	200	500
SCt	92	YES	300	1100
TRT	256	YES	300	1200
E.m. calorimeter	724	YES	752	752
Hadron calorimeter	32 (Tilecal)	YES	752	752
	24 (LAr)	YES	752	752
Muon precision	192	YES	800	800
Muon trigger (RPCs and TGCs)	48	YES	380	380
CSC	32	NO	200	200
FCAL	16	NO	1400	1400
LVL1	56	NO	1200 (average)	1200 (average)
Total event size, raw			1006864	1346864
Total event size, with headers			1183352	1523352

### A.3 Parameters relevant for LVL2 processing

The LVL2 processing consists of several steps and after each step a decision is taken on whether data from other subdetectors within the region-of-interest should be requested for further analysis. Table A-3 shows the subdetector data requested by different processing steps of the LVL2 trigger for the four different types of Rols. The associated acceptance factors are also specified in the table. As the LVL1 trigger defines a finite number of possible Rol locations, the data rates can be estimated using these factors along with information on the sizes and locations of the regions-of-interest, and the mapping of the detector on the ROBins. A small region in eta-phi space corresponds to a location. A hit in this region satisfying appropriate LVL1 trigger criteria generates a Rol with a location corresponding to the region. The relative Rol rate for each location is assumed to be proportional to the surface of this region, while the sum of the rates for all possible locations should be equal to the LVL1 menu Rol rate. This makes it possible to determine the rate for each possible location. In combination with the Rol sizes (see Table A-4) and the mapping of the detector on the ROBins, the Rol data request rates for each ROBIN can be calculated.

In order to establish the processing resources needed for the LVL2 trigger the algorithm execution times and the overheads for sending requests and receiving data are needed. See Table A-5 for current estimates, assuming execution on 4 GHz machines. The numbers specified include estimates of the time needed for data preparation. Furthermore, for each Ethernet frame sent and received overheads of 4  $\mu$ s and 8  $\mu$ s respectively are taken into account. These values have been estimated from measurement results for the SFI (see Section 8.3.2.3). The processing step

resulting in a decision is assumed to take 50  $\mu$ s. Merging of event fragments into a larger fragment suitable for input to the algorithms is assumed to proceed at 160 Mbyte/s.

**Table A-3** Subdetector data requested by different processing steps of the LVL2 trigger for the different types of ROIs and associated acceptance factors. The acceptance factors are relative to the LVL1 ROI rate.

Type of ROI	First step	Acceptance factor	Second step	Acceptance factor	Third step
EM	E.m. calorimeter	0.19 (design lum.: 0.16)	Hadron calorimeter	0.11 (design lum.: 0.16)	TRT/SCT/Pixels
JET	E.m. and hadron calorimeters	1.0			
TAU	E.m. and hadron calorimeters	0.2	TRT/SCT/Pixels		
MUON	Muon precision and trigger detectors	0.39	SCT/Pixels	0.086	E.m. and hadron calorimeters (only for design luminosity)

**Table A-4** LVL2 ROI sizes

Type of ROI	Size in eta	Size in phi
EM	0.2	0.2
JET	0.8	0.8
TAU	0.2	0.2
MUON	$\sim 0.3$ - $0.4$ (depends on detector)	$\sim 0.1$ - $0.4$ (smallest in muon and in inner detector)

**Table A-5** Estimated execution times (in ms) of LVL2 algorithm steps on a 4 GHz processor, for low and design luminosity respectively. The estimated time needed for data preparation has been included in the ROI processing times. The algorithm execution times are the  $m_{95}$  values (see chapter...).

Type of ROI or trigger	Muon detectors	Calorimeters	TRT	SCT + Pixels
EM		0.088/0.123 (e.m.) 0.023/0.032 (hadron)	8.33/24.56	1.36/3.88
JET		0.68/0.68		
TAU		0.044/0.061 (e.m.) 0.011/0.016 (hadron)	8.33/24.56	1.36/3.88
MUON	0.5/0.5	0.044/0.061 (e.m.) 0.011/0.016 (hadron)	8.33/--	1.36/3.88

#### A.4 Parameters relevant for Event Builder and Event Filter

Events need to be fully built at a rate equal to the acceptance rate of the LVL2 trigger (0.6 or 1.5 kHz) and then to be analysed by the Event Filter. The Event Filter is expected to reduce the rate by a factor of 10 (see ch....) with a typical processing time of one second per event, which requires a farm of at least 300 or 750 dual-CPU PCs.

#### A.5 Data rate summaries

The LVL2 system and the Event Builder both send requests for data to the ROBINs. The rate of the requests from the Event Builder is equal to the event building rate, i.e. 0.6 or 1.5 kHz at nominal LVL1 trigger rate. The LVL2 request rate per ROBIN for a given subdetector, averaged over all ROBINs, and the average number of requests for the ROBIN with the highest average are presented in Table A-6. The total data volume (data sent to the LVL2 trigger and to the Event Builder) output per ROBIN for a given subdetector, averaged over all ROBINs, and the volume output for the ROBIN with the highest average are presented in Table A-7. Similar numbers are given in Table A-8 and Table A-9 for ROS units handling data from 12 ROIs (for each subdetector, groups of 12 ROIs have been formed, without regard for the partitioning of the subdetector; for cases where the number of ROIs is not a multiple of 12, the ROS unit with less than 12 ROIs connected has not been included in the calculation of the averages). Data Collection and Raw Ethernet wrappers have been taken into account in the data volumes output by the ROS units.

**Table A-6** LVL2 request rate per ROBIN in kHz at nominal LVL1 rate. Here 'overall average' denotes an average over all ROBINs and 'maximum average' is an average for the ROBIN with the highest average number of requests.

	Muon trigger	Muon precision	E.m. calorimeter	Hadron calorimeter	TRT	SCT	Pixels
Low (overall average)	0.02	0.04	0.41	0.27	0.03	0.11	0.13
Low (max. average)	0.04	0.06	1.49	0.40	0.04	0.15	0.20
Design (overall average)	0.10	0.22	0.60	0.31	0.01	0.27	0.34
Design (max. average)	0.20	0.30	2.19	0.45	0.02	0.37	0.49



**Table A-7** Output data volume per ROBIN in Mbytes (LVL2 data and data sent to the Event Builder) at nominal LVL1 rate. Here 'overall average' denotes an average over all ROBINS and 'maximum average' is an average for the ROBIN with the highest average number of requests.

Luminosity	Hadron						
	Muon trigger	Muon precision	E.m.-ca-lorimeter	Hadr.-ca-lorimeter	TRT	SCT	Pixels
Low (overall average)	0.56	0.31	0.86	0.75	0.26	0.29	0.22
Low (max. average)	0.58	0.32	1.79	0.86	0.26	0.30	0.24
Design (overall average)	1.45	0.83	1.80	1.55	1.97	2.13	1.11
Design (max. average)	1.53	0.87	3.15	1.67	1.98	2.25	1.20

**Table A-8** LVL2 request rate per ROS unit (12 ROLs) in KHz. Here 'overall average' denotes an average over all ROBINS and 'maximum average' is an average for the ROBIN with the highest average number of requests

Luminosity	Hadron						
	Muon trigger	Muon precision	E.m.-ca-lorimeter	Hadr.-ca-lorimeter	TRT	SCT	Pixels
Low (overall average)	0.2	0.4	2.4	1.9	0.2	0.8	1.0
Low (max. average)	0.3	0.5	4.3	2.1	0.3	0.9	1.5
Design (overall average)	0.9	1.9	3.6	2.1	0.1	2.0	2.6
Design (max. average)	1.4	2.4	6.4	2.4	0.1	2.2	3.9

**Table A-9** Output data volume per ROS unit (12 ROLs) in Mbytes (LVL2 data and data sent to the Event Builder) at nominal LVL1 rate. Here 'overall average' denotes an average over all ROBINS and 'maximum average' is an average for the ROBIN with the highest average number of requests.

Luminosity	Hadron						
	Muon trigger	Muon precision	E.m.-ca-lorimeter	Hadr.-ca-lorimeter	TRT	SCT	Pixels
Low (overall average)	6.9	3.9	10.9	9.4	3.2	3.7	2.9
Low (max. average)	7.1	4.0	14.1	10.1	3.2	3.8	3.1
Design (overall average)	17.9	10.5	22.5	19.3	24.3	26.6	14.0
Design (max. average)	18.6	10.8	27.2	20.1	24.3	27.5	14.9

## A.6 Overview of paper model results

**Table A-10** and **Table A-11** contain an overview of results obtained with the paper model for the nominal LVL1 rate and extrapolated to 75 KHz LVL1 rate respectively.

**Table A-10** Overview of paper model results for the nominal LVL1 trigger rate

	Low luminosity	Design luminosity
LVL1 trigger rate (KHz)	20.1	34.5
Average number of ROBINS receiving a RoI request, per LVL1 trigger	17.9	16.2
Average number of groups of 12 ROBINS receiving a RoI request, per LVL1 trigger	9.0	8.5
Maximum average output bandwidth (for LVL2 and Event Builder data) per ROBIN (Mbyte/s)	1.8	3.2
Maximum average RoI request rate per ROBIN (KHz)	1.5	2.2
Maximum average output bandwidth (for LVL2 and Event Builder data) per 12 ROBINS (Mbyte/s)	14.1	27.2
Maximum average RoI request rate per 12 ROBINS (KHz)	4.3	6.4
Total bandwidth of LVL2 traffic (Gbyte/s)	0.31	0.52
LVL2 farm size	32	65
Fragment rate in = request rate out per L2PU (KHz)	5.7	4.5
Fragment volume in per L2PU (Mbyte/s)	9.9	7.7
Decision rate per L2PU (KHz)	0.63	0.53
Total bandwidth of traffic to Event Builder (Gbyte/s)	0.72	2.3
Event Building rate (KHz)	0.6	1.5
Number of SFTs required	12	38

**Table A-11** Overview of paper model results for 75 KHz LVL1 trigger rate

	Low luminosity	Design luminosity
Average number of ROBIns receiving a RoI request, per LVL1 trigger	17.9	16.2
Average number of groups of 12 ROBIns receiving a RoI request, per LVL1 trigger	9.0	8.5
Maximum average output bandwidth (for LVL2 and Event Builder data) per ROBIn (Mbyte/s)	6.7	6.9
Maximum average RoI request rate per ROBIn (KHz)	5.6	4.8
Maximum average output bandwidth (for LVL2 and Event Builder data) per 12 ROBIns (Mbyte/s)	53	59.
Maximum average RoI request rate per 12 ROBIns (KHz)	16	14
Total bandwidth of LVL2 traffic (Gbyte/s)	1.2	1.1
LVL2 farm size	120	140
Fragment rate in = request rate out per L2PU (KHz)	5.7	4.5
Fragment volume in per L2PU (Mbyte/s)	9.8	8.0
Decision rate per L2PU (KHz)	0.63	0.54
Total bandwidth of traffic to Event Builder (Gbyte/s)	2.7	5.0
Event Building rate (KHz)	2.2	3.3
Number of SFls required	45	82

## B Glossary

The glossary has been split into two sections, one with acronyms and their meaning, and another with actual definitions of some terms.

### B.1 Acronyms

<b>API</b>	Application Program Interface
<b>ASIC</b>	Application Specific Integrated Circuit
<b>ATLAS</b>	A Toroidal LHC Apparatus
<b>BC</b>	Bunch Crossing
<b>BCID</b>	Bunch Crossing Identifier
<b>BCR</b>	Bunch Counter Reset
<b>BE</b>	Back-End
<b>CAN</b>	Controller Area Network
<b>CBR</b>	Constant Bit Rate
<b>CBQ</b>	Class Base Queuing
<b>CERN</b>	European Laboratory for Particle Physics
<b>CF</b>	Connect Forum
<b>CFS</b>	Complex Front-end Systems
<b>CIC</b>	Common Infrastructure Controls
<b>CMA</b>	Coincidence Matrix
<b>CMC</b>	Common Mezzanine Card
<b>CMT</b>	Configuration Management Tool
<b>Conddb</b>	Conditions Database
<b>Conddb</b>	Configuration Database
<b>CORBA</b>	Common Object Request Broker Architecture
<b>COTS</b>	Commodity/Commercial Off-The-Shelf
<b>CP</b>	Cluster Processor
<b>CSC</b>	Cathode Strip Chamber
<b>CTP</b>	Central Trigger Processor
<b>DAL</b>	Data Access Library
<b>DAQ</b>	Data Acquisition System
<b>DBMS</b>	Database Management System
<b>DC</b>	Data Collection
<b>DCS</b>	Detector Control System

<b>DDC</b>	DAQ-DCS Communication
<b>DDC-CT</b>	DDC Control Transfer
<b>DDC-DT</b>	DDC Data Transfer
<b>DDC-MT</b>	DDC Message Transfer
<b>DF</b>	DataFlow System
<b>DFM</b>	Data Flow Manager
<b>DID</b>	Destination Identifier
<b>DIG</b>	Detector Interface Group
<b>DMA</b>	Direct Memory Access
<b>DSA</b>	Diagnostics Supervision Agent
<b>DSP</b>	Digital Signal Processor
<b>DSS</b>	Detector Safety System
<b>DVS</b>	Diagnostics and Verification System
<b>EB</b>	Event Builder
<b>EBN</b>	EB Network
<b>ECAL</b>	Electromagnetic Calorimeter
<b>ECR</b>	Event Counter Reset
<b>ED</b>	Event Dump
<b>EDM</b>	Event Data Model
<b>EF</b>	Event Filter
<b>EFD</b>	Event Filter Data flow
<b>EFL</b>	Event Format Library
<b>EFN</b>	EF Network
<b>EFPU</b>	EF Processing Unit (processor)
<b>EH</b>	Event Handler
<b>EL1ID</b>	Extended Level-1 ID
<b>ELMB</b>	Embedded Local Monitor Board
<b>EMB</b>	Electromagnetic Barrel
<b>EMEC</b>	Electromagnetic Endcap
<b>EMS</b>	Event Monitoring Service
<b>ERS</b>	Error Reporting Service
<b>ESA</b>	European Space Agency
<b>ESS</b>	Event Selection Software
<b>EVS</b>	Event Viewing System
<b>FC</b>	Flow Control

<b>FCAL</b>	Forward Calorimeter
<b>FDR</b>	Final Design Review
<b>FE</b>	Front-End
<b>FEC</b>	Front-End Controller
<b>FEL</b>	Front-End Link
<b>FILAR</b>	Four Input Links for ATLAS Readout
<b>FPGA</b>	Field Programmable Gate Array
<b>FSM</b>	Finite State Machine
<b>GCS</b>	Global Control Station
<b>GID</b>	Global event Identifier
<b>HEC</b>	Hadronic Endcap Calorimeter
<b>HLT</b>	High Level Trigger
<b>HMI</b>	Human Machine Interface
<b>HOL</b>	Head Of Line
<b>HOLA</b>	High-speed Optical Link for ATLAS
<b>ID</b>	Inner Detector
<b>IDC</b>	Identifiable Container
<b>IGUI</b>	Integrated Graphical User Interface
<b>ILU</b>	Inter-Language Unification system
<b>IOM</b>	I/O Module
<b>IOV</b>	Interval Of Validity
<b>IP</b>	Interaction Point
<b>IP</b>	Internet Protocol
<b>IPC</b>	Inter-Process Communication
<b>IPC_REF_FILE</b>	IPC Reference File
<b>IS</b>	Information System
<b>JCOP</b>	Joint Controls Project
<b>JDBC</b>	Java Database Connectivity
<b>JEP</b>	Jet Energy Processor
<b>L1A</b>	LVL1 accept
<b>L1ID</b>	LVL1 Trigger Accept Identifier
<b>L2N</b>	LVL2 Network
<b>L2P</b>	LVL2 Processor
<b>L2PU</b>	Level-2 Processing Unit (application)
<b>L2SV</b>	Level-2 Supervisor

<b>LAr</b>	Liquid Argon
<b>LAN</b>	Local Area Network
<b>LBSF</b>	Local Buffering and Storage Facility
<b>LCG</b>	LHC Computing Grid
<b>LCS</b>	Local Control Station
<b>LDC</b>	Link Destination Card
<b>LHC</b>	Large Hadron Collider
<b>LVL1</b>	Level-1 trigger system
<b>LVL2</b>	Level-2 trigger system
<b>LSC</b>	Link Source Card
<b>LTP</b>	Local Trigger Processor
<b>LUT</b>	Look-Up Table
<b>MAC</b>	Media Access Control
<b>MDT</b>	Monitored Drift Tube
<b>MRS</b>	Message Reporting System
<b>MSSM</b>	Minimal Supersymmetric Model
<b>MTTF</b>	Mean Time To Failure
<b>NIC</b>	Network Interface Card
<b>OBK</b>	Online Book Keeper
<b>ODBC</b>	Open Database Connectivity
<b>OHS</b>	Online Histogramming Service
<b>OKS</b>	Object Kernel Support
<b>OLE</b>	Object Linking and Embedding
<b>OMG</b>	Object Management Group
<b>OPC</b>	OLE for Process Control
<b>OSF</b>	Online Software Farm
<b>OSN</b>	Online Software Network
<b>PCI</b>	Peripheral Component Interconnect
<b>PDR</b>	Preliminary Design Review
<b>PESA</b>	Physics and Event Selection Architecture
<b>PID</b>	Partition Identifier
<b>PLC</b>	Programmable Logic Controller
<b>PMG</b>	Process Manager
<b>PP</b>	Pre-Processor
<b>pROS</b>	pseudo-ROS

<b>PRR</b>	Production Readiness Review
<b>PSC</b>	PESA Steering Controller
<b>PT</b>	Processing Task
<b>QoS</b>	Quality of Service
<b>RC</b>	Run Control System
<b>RCC</b>	ROD Crate Controller
<b>RCM</b>	ROD Crate Module
<b>RCP</b>	ROD Crate Processor
<b>RCW</b>	ROD Crate Workstation
<b>RDB</b>	Remote Database
<b>RDO</b>	Raw Data Object
<b>RIO</b>	Reconstruction Input Object
<b>RM</b>	Resource Manager
<b>ROB</b>	Read-Out Buffer
<b>ROBin</b>	Read-Out Buffer input
<b>ROC</b>	Read-Out Crate (Specific implementation of a ROS)
<b>ROD</b>	Read-Out Driver
<b>RoI</b>	Region of Interest
<b>RoIB</b>	Region of Interest Builder
<b>ROL</b>	Read-Out Link
<b>ROS</b>	Read-Out Sub-system
<b>RPC</b>	Resistive Plate Chamber
<b>RRC</b>	ROD to ROB Connection
<b>RRM</b>	ROB to ROS Multiplexer
<b>RT</b>	Real Time
<b>RUP</b>	Rational Unified Process
<b>SCADA</b>	Supervisory Control and DAQ
<b>SCS</b>	Sub-system Control Station
<b>SCT</b>	Silicon Tracker
<b>SCX</b>	Surface control room
<b>SDP</b>	Software Development Process
<b>SDX</b>	Surface counting room
<b>SERDES</b>	SERIAL DESerialiser
<b>SFC</b>	Sub-Farm Crate
<b>SFI</b>	Sub-Farm Input

<b>SFO</b>	Sub-Farm Output
<b>SID</b>	Source Identifier
<b>S-LINK</b>	Simple Link Interface
<b>STL</b>	Standard Template Library
<b>STP</b>	Spanning Tree Protocol
<b>TBF</b>	Token Bucket Filter
<b>TCP</b>	Transmission Control Protocol
<b>TDAQ</b>	ATLAS Trigger/DAQ/DCS
<b>TDR</b>	Technical Design Report
<b>TES</b>	Transient Event Store
<b>TGC</b>	Thin Gap Chamber
<b>TM</b>	Test Manager (also TMGR)
<b>TMGR</b>	Test Manager
<b>TOF</b>	Time Of Flight
<b>TRG</b>	Trigger Module (function inside present implementation of ROS)
<b>TRT</b>	Transition Radiation Tracker
<b>TTC</b>	Timing, Trigger and Control (TTC)
<b>TTCrX</b>	TTC Receiver
<b>TTCvi</b>	TTC VME Interface
<b>UDP</b>	User Datagram Protocol
<b>URD</b>	User Requirements Document
<b>US15</b>	Underground service area
<b>USA15</b>	Underground counting room
<b>UX15</b>	Experimental cavern
<b>VLAN</b>	Virtual Local Area Network
<b>WRR</b>	Weighted Round Robin
<b>XML</b>	Extensible Markup Language

## B.2 Definitions

### Bunch Crossing Identifier (BCID)

Number that defines the bunch crossing at which an event occurred. Potential bunch crossings are numbered 0 to 3563 per LHC orbit, starting with the first following the LHC extractor gap.

**Bunch Counter Reset (BCR)**

Signal Broadcast by the TTC system once per LHC orbit to control the phase of local bunch counters.

**Back-End (BE)**  
Part of the DCS system furthest from the detector (as opposed to Front-End)

**Central Trigger Processor (CTP)**

The place where the LV11 trigger is generated.

**Conditions database (Conddb)**

The conditions database contains the record of the detector conditions required for data analysis, e.g. calibration and geometry constants.

**Configuration databases (Conddb)**

The configuration databases store the parameters necessary to configure the TDAQ system's architecture, hardware and software components, and running modes.

**TDAQ Run or Run**

A continuous period in time of data taking using a given hardware and software configuration and a defined set of run parameters. It is identified by a unique run number. The run begins when the TDAQ, detectors and other sub-systems are correctly configured and the machine conditions are acceptable. A run terminates either cleanly when the pre-defined goals of the run are met (e.g. a certain number of events have been taken) or aborts when a serious unexpected problem occurs (e.g. loose the beam or the machine conditions are unacceptable etc.) or when the configuration of the partition changes.

**DataCollection (DC)**

DataCollection is a subsystem of the Atlas TDAQ DataFlow system responsible for the movement of event data from the ROS to the High Level Triggers. This includes data from Regions of Interest (RoIs) for LV12 Processing, building complete events for the Event Filter and finally transferring accepted events to Mass Storage. It also handles passing the LV11 RoI pointers and the allocation of LV12 processors and load balancing of Event Building.

**DataCollection Framework**

A set of services used by all LV12 and EB applications, which provides a unified program structure and common interfaces to Configuration Database, Run Control and other Online Software services.

**Data Flow Manager (DFM)**

The DFM orchestrates the correct flow of data fragments between ROSS and SFTs. It is triggered by the L2SV, load balances the event building tasks on the SFTs and ensures that the ROSS do not overflow their internal memory buffers.

**Data Flow system (DF)**

System comprising the ROS and DC, HLT subsystems.

**Detector Control System (DCS)**

It comprises the control of the subdetectors and of the common infrastructure of the experiment and the communication with the services of CERN (cooling, ventilation, electricity distribution, safety etc.) and the LHC accelerator.

**Diagnostic package (DVS)**

This element uses the test manager to diagnose problems with the TDAQ system and confirm its functionality.

**Event**

All ROB fragments from the same beam crossing. Identified by run number and GID after event building.

**Event Builder (EB)**

Part of the DF system, it merges all the fragments belonging to a unique EL11D into a full event at a single destination and assigns a GID.

**Event Counter Reset (ECCR)**

Signal broadcast by the TTC system to reset the local event counters.

**Event Filter (EF)**

The hardware and software required for the final stage of the on-line event selection, data monitoring and calibration using offline style algorithms operating on complete events accepted by LV12.

**Event Filter Dataflow (EED)**

Part of the EF system responsible for the flow of event data within the EF.

**Event Filter Farm**

The farm of processors in which the Event Filter runs. The same farm may also be used for different purposes, e.g. calibration, by running different software on the farm.

**Event Filter Sub-Farm**

A sub-set of the Event Filter Farm. Input and output are provided, respectively, by the Sub Farm Input and Output elements.

**Event filter supervisor**

The hardware and software required to globally control the Event Filter. It is also responsible for the configuration, initialisation, and overall error handling of the Event Filter.

**Event fragment**

A generic term for a sub-set of event data. Specific instances of an event fragment are ROD, ROB, ROS, and sub-detector fragments.

**Event Handler (EH)**

The logical object within the EF consisting of an event distributor, an event collector, one or more processing elements, an event handler supervisor and an appropriate communication layer.

**Extended Level-1 ID (EL11D)**

The L11D extended to 32 bits by concatenating an 8 bit ECR counter in the high end bits.

**Global event Identifier (Gid)**

For a given run, the unique TDAQ wide identifier of an event added to the event during event building.

**High Level Triggers (HLT)**

Comprised of both the LVL2 and EF, the two ATLAS trigger levels that are implemented primarily in software.

## C Participating Institutes

### C.1 Authors from participating institutes

The following is the list of institutes which are participating in the ATLAS High-Level Trigger, Data Acquisition, and Detector Control System collaboration, together with the names of the physicists and senior engineers concerned. Short names are given for each institute; for the official name and location see the opening pages of this document.

**Alberta**

B. Caron, J. de Jong, J.L. Pinfold, R. Soluk, S. Wheeler

**Argonne**

R.E. Blair, J. Dawson, J. Schlereth

**Barcelona - IFAE**

M. Bosman, M. Dosl, K. Karrl, G. Merino, A. Pacheco, E. Segura

**Bern**

H.P. Beck, G. Commue, S. Gadomski<sup>2</sup>, C. Haeblerli, S. Kabana, V. Perez-Reales, K. Pretzl, A. Radu

**Bucharest**

E. Badescu, M. Caprini

**CERN**

S. Armstrong, M. Barczyk, J.A.C. Bogaerts, V. Boisvert, D. Burckhart-Chronek, H. Burckhart, M.P. Casado Lechuga, M. Ciobotaru, J. Da Silva Conceicao, J. Cook, P.J. de Matos Lopes Pinto, M. Eising, B. Di Girolamo, R. Dobson, M. Dobson, N. Ellis, J. Flammer, D. Francis, S. Gameiro, P. Golonka, B. Gorini, M. Grothe, M. Gruwe, B.I. Hallgren, S. Haas, R. Jones, M. Joos, E. Knezo, G. Lehmann, D. Liko, T. Maeno, B. Martin, C. Meitrosu, L. Mapelli, R. McLaren, E. Moyses, G. Mornacchi, C. Padilla, E. Palencia Cortezon, I. Papadopoulos, J. Petersen, A. Poppleton, D. Prigent, S. Rosati, T. Schoerner-Sadenius, S. Stancu, R. Spivovks, L. Tremblat, E. van der Bijl, F. Varela, T. Wengler, P. Werner

**Copenhagen**

H. Bertelsen, M. Dam, J.R. Hansen, A. Wäänänen

**Cracow**

Z. Hągluk, W. Iwanski, A. Kaczmarska, K. Korcyl, J. Olszowska, M. Zurek

**Geneva**

A. Clark, L. Moneta<sup>3</sup>, I. Riu, M. Diaz Gomez<sup>4</sup>, A. Straessner

**Genoa**

M. Cervetto, P. Morettini, F. Parodi, C. Schiavi

1. now at Argonne
2. on leave from H. Niewodniczanski Inst. of Nuclear Physics, Cracow
3. now at CERN
4. now at CERN

**Hiroshima Institute of Technology**  
Y. Nagasaka**Innsbruck**

B. Epp, V.M. Ghele, E. Kneringer, D. Kuhn, A. Nairzl, A. Salzburger

**JINR**

I. Alexandrov, V. Kotov, S. Korobov, M. Mineev, V. Tryanin, D. Yanovich

**KEK**

H. Fujii, A. Manabe, K. Nakayoshi, Y. Watase, Y. Yasu

**Lancaster University**

M. Smitzanska

**Lecce**

G. Cataldi, G. Chiodini, E. Gorini, M. Primavera, S. Spagnolo

**Lisbon FCUL**

A. Amorim, L. Pedro, J. Lima, D. Klose, C. Oliveira, N. Barros, J. Villate, H. Wolters

**LNF, Frascati**

M. Beretta, M.L. Ferrer, W. Liu, I. Sfiligoi

**London RBHNC**

S. George, B. Green, A. Lowe, A. Mistejlik, J. Strong, P. Teixeira-Dias

**London UCL**

P. Clarke, R. Cranfield, G. Crone, J. Drohan, N. Konstantinidis, M. Muller

**Mainz**

L. Koepke

**Manchester**

R.E. Hughes-Jones

**Mannheim**

C. Hinkelbein, A. Khomich, A. Kugel, R. Männer, M. Müller, M. Yu

**Marseille**

C. Bee, F. Etienne, C. Meessen, Z. Qian, F. Touchard

**Michigan State**

M. Abolins, R. Brock, Y. Ermolov, R. Hauser, B.G. Pope

**Moscow SU**

N. Nikitin, S. Sivoklokov, L. Smitrnova

**Nagasaki**

M. Shinnojima, Y. Tanaka

1. now at CERN



**Naples**  
M. Biglietti, G. Carlino, F. Conventi, L. Merola

**NIKHEF**  
M. Bartsoszi<sup>1</sup>, H. Boterenbrood, R.G.K. Hart, W.P.J. Heubers, P.P.M. Janszweijer, G.N.M. Klef, R. Scholte<sup>2</sup>, J.C. Vermeulen

**Pavia**  
R. Ferrari, A. Negri, G. Polesello, D.A. Scannicchio, V. Vercesi

**Petersburg NPI**  
V. Filimonov, S. Katunin, A. Kazarov, V. Khomutnikov, S. Kolos, Y. Ryabov, I. Solovlev

**Prague AS & CU**  
J. Chyła, J. Dolejši

**RAL**  
J.T.M. Baines, D.R. Botterill, W. Li, F.J. Wickens

**Rio de Janeiro**  
M. Losada Maia, A.G. Mello, A. dos Anjos, J.M. de Seixas

**Rome I**  
A. Di Mattia, S. Falciano, C. Luci, L. Luminari, F. Marzano, A. Nisati, E. Pasqualucci

**Rome III**  
P. Branchini, A. Farilla, C. Stanescu

**Shinsyu**  
Y. Hasegawa, T. Takeshita

**Tel Aviv**  
H. Abramowicz, Y. Benhammou, E. Elzion

**Univ. California Irvine**  
A.J. Lankford, R. Mommsen, S. Pier, M. Schemau

**Weizmann Institute of Science**  
D. Lellouch, L. Levinson

**Wisconsin**  
S. Gonzalez, W. Wiedenmann, N. Xu, S.L. Wu, H. Zobernig

---

1. also University of Twente  
2. also University of Twente

## C.2 Authors from non participating institutes

The following is the list of authors belonging to institutes which are not participating in the ATLAS High-Level Trigger, Data Acquisition, and Detector Control System collaboration.

D. Cavalli	INFN Milano
W. Krasny	Paris VI, VII??
M. Le Vine	Brookhaven
S. Tapprogge	Helsinki
A. Watson	Birmingham
M. Wielers	Grenoble
K. Assamagan	Brookhaven
H. Ma	Brookhaven
S. Rajagopalan	Brookhaven
G. Stavropoulos	Berkeley LBNL & UC

This document has been prepared with Release 6.0 of the Adobe FrameMaker® Technical Publishing System using the Technical Design Report template prepared by Mario Ruggier of the Information and Programming Techniques Group, ECP Division, CERN, according to requirements from the ATLAS collaboration.

To facilitate multiple author editing and electronic distribution of documents, only widely available fonts have been used. The principal ones are:

Running text:	Palatino 10.5 point on 13 point line spacing
Chapter headings:	Helvetica Bold 18 point
2nd, 3rd and 4th level headings:	Helvetica Bold 14, 12 and 10 point respectively
Figure and table captions:	Helvetica 9 point